

Arrangement Graphs and Intersection Graphs of Curves

by

Uma kant Sahoo

Advanced Computing and Microelectronics Unit
Indian Statistical Institute
Kolkata, India



A thesis submitted in partial fulfillment
of the requirement for the degree of
Doctor of Philosophy
in
Computer Science

Thesis Advisor: Prof. Sandip Das

February, 2022

Abstract

An *arrangement* of a set of non-self-intersecting curves is their embedding in the Euclidean plane, such that at each intersection point, the curves involved cross each other. Arrangements are well-studied both in Discrete Geometry and Computational Geometry. They serve as natural sources of graphs. In this thesis, we investigate two such graph classes that naturally arise from arrangements of curves.

The first graph class, called *arrangement graphs*, arises directly from the embedding itself by considering the intersection points as vertices and the segments of curves whose endpoints are the only vertices in it are the edges of the graph. The second graph class, called *intersection graphs* of finite curves, is obtained by treating each curve as a vertex and two vertices are adjacent if their corresponding curves intersect.

We begin with arrangement graphs. A *pseudoline* is a curve that extends to infinity in both the ends such that two pseudolines can intersect at most once where they cross each other. A pseudoline arrangement is a collection of at least three pseudolines. It is *simple* if no three pseudolines meet at a point and there are no parallel pseudolines. A *pseudoline arrangement graph* is obtained from a simple pseudoline arrangement. First, we solve the *Pseudoline Arrangement Graph Realization Problem*, that is, given a sequence of finite numbers whether there is a pseudoline arrangement graph whose list of degrees of its vertices matches with the input sequence. And if the answer is yes, then we construct the pseudoline arrangement graph. Second, we study the *eccentricities* of vertices in pseudoline arrangement graphs. In particular, we find the *diameter* of such graphs, and then characterize the vertices that have eccentricity as the diameter.

Next, we move on to intersection graphs. A *string graph* is the intersection graph of finite curves. When these finite curves pairwise intersect at

most once, we get *1-string graphs*. An *outerstring graph* is a string graph obtained from the arrangement of finite curves in a disk such that an endpoint of each curve lies on the boundary of the disk. Kostochka and Nešetřil studied coloring 1-string graphs with girth five to address questions of Erdős and of Kratochvíl and Nešetřil. In an attempt to improve these bounds we prove that outerstring graphs with girth $g \geq 5$ and minimum degree at least 2 have a chain of $(g - 4)$ vertices with degree 2. This generalizes results of Ageev and of Esperet and Ochem on *circle graphs*: intersection graphs of chords of a circle. Our result also implies that outerstring graphs with girth at least five are 3-colorable, improving the previous bound of five by Gavenciak et al.

Next, we consider a geometric analogue of string graphs called *bend graphs*: intersection graphs of rectilinear curves. Upon fixing these rectilinear curves to be alternating horizontal and vertical line segments in the plane of at most $k + 1$ line segments, we obtain the graph class \mathcal{B}_k . Clearly \mathcal{B}_k are also string graphs. However, every string graph also belongs to \mathcal{B}_k , for some k . The smallest value of k such that a string graph $G \in \mathcal{B}_k$ is called its *bend number*. This parameter gives us a way of categorizing string graphs. Obviously $\mathcal{B}_k \subseteq \mathcal{B}_{k+1}$. Chaplick et al. were the first to provide such a separating example proving that $\mathcal{B}_k \subsetneq \mathcal{B}_{k+1}$ for all $k \in \mathbb{N}$, and further asked for chordal separating examples. In an attempt to answer their question, we show that there are infinitely many values of k such that there are separating examples for $\mathcal{B}_k \subsetneq \mathcal{B}_{k+1}$ that are split graphs (which are also chordal). We also prove similar results for a different variant of bend number called the *proper bend number*.

Finally, we close by highlighting the use of techniques developed for arrangement graphs that help to solve problems of string graphs. In particular, we focus on the result of Kostochka and Nešetřil on coloring 1-string graphs with girth five.

Acknowledgements

First, I would like to thank my supervisor Sandip sir. I am grateful for the opportunity he provided. In particular, the environment he has created, which allows for both collaborative as well as independent research.

I am indebted to my teachers Pratima madam, Bagchi sir, and Rao sir for showing me the joy in research. My research principles and temperament are shaped by them.

Next, I thank Joydeep da and Sagnik da for their collaborations. In particular, to Joydeep da for guiding me through the exploration of the topological flavors of the problems. In fact, the part on intersection graphs would not have been possible without him.

I would like to thank my friends and fellow group members Harmender and Subhadeep with whom I have shared a lot of discussions, both academic and otherwise.

A special thanks to Akshay and Arpan with whom I have shared numerous conversations about problems and topics outside of my research. Life here without this would have been bland.

Finally, I thank all my teachers during these years at ISI Kolkata: Sandip sir, Subhamoy sir, Rana sir, Susmita madam, Sasanka sir, Subhas sir, Shreesh Maharaj, Sagnik da, Arijit da, Samik sir, and Rajat sir.

Contents

Abstract	iii
Acknowledgements	v
Contents	ix
Preface	1
A Recurring Theme	3
Preliminaries	5
1 Introduction	9
1.1 Arrangements of Curves	9
1.1.1 Some Interesting Connections of Arrangements	11
1.1.2 History and Motivation	13
1.1.3 Natural Sources of Graphs	15
Part: ARRANGEMENT GRAPHS OF CURVES	18
1.2 Pseudoline Arrangement Graphs	18
1.2.1 The Pseudoline Arrangement Graph Realization Problem	20
1.2.2 Eccentricities in Pseudoline Arrangement Graphs	21
Part: INTERSECTION GRAPH	23
1.3 String Graphs	25
1.3.1 Subclasses of interest	28
1.3.2 Coloring 1-string graphs	30
1.4 Bend Graphs	33
1.4.1 EPG Graphs	35
1.4.2 VPG Graphs	37
Part: INTERPLAY	41
1.5 The Coloring Question of Kostochka and Nešetřil	41
1.6 Organization of the Thesis	42
1.7 Final Remarks	44
2 Pseudoline Arrangement Graphs	45
2.1 Introduction	45
2.2 Our Results	48
2.2.1 The Pseudoline Arrangement Graph Realization Problem	48
2.2.2 Eccentricities in Pseudoline Arrangement Graphs	50

2.3	Tools Used	52
2.3.1	Definitions and Notations	52
2.4	Pseudoline Arrangement Graph Realization Problem	53
2.4.1	Proof of Necessity of Theorem 1	54
2.4.2	Construction and Operations	55
2.4.3	Proof of Sufficiency of Theorem 1	57
2.5	Eccentricities in Pseudoline Arrangement Graphs	59
2.5.1	Basic Results	59
2.5.2	Diameter and Characterization of Vertices with Maximum Eccentricity	63
2.6	Final Remarks	67
2.6.1	Following our Theme	67
2.6.2	Open Problems	67
2.6.3	Alternate Proof of $d_2 \geq 3$ in Theorem 1 using Wiring Diagrams	68
2.6.4	A Brief Review on Degree Sequence-based Characterizations	69
2.6.5	Acknowledgements	70
3	Outerstring graphs of girth five are 3-colorable	71
3.1	Introduction	71
3.1.1	Coloring problems	72
3.1.2	The Frameworks of Kostochka and Nešetřil	73
3.1.3	Problems and Results	74
	Part: GROUNDED-L GRAPHS	76
3.2	Preliminaries for grounded-L graphs	77
3.3	Proofs of Theorem 3 and Theorem 4	79
3.3.1	Grounded-L representations of Cycles	79
3.3.2	The target degree two vertex	80
	Part: OUTER 1-STRING GRAPHS	83
3.4	Tools, Definitions and Notations	83
3.4.1	Tools from Topological graph theory	83
3.4.2	Basic Definitions	84
3.4.3	Specific Definitions	85
3.5	Outline of The Main Proof	89
3.6	Outer 1-string Representation of Cycles	90
3.7	Outer 1-string Representations and Branching Argument	94
3.8	A Stronger Claim and its Proof	95
	Part: OUTERSTRING GRAPHS	109
3.9	Tools, Definitions and Notations	110
3.9.1	Basic Definitions	110
3.9.2	Specific Definitions	110
3.10	Outerstring Representation of Cycles	115
3.11	Outerstring Representations and Branching Argument	120

3.12	A Stronger Claim and its Proof	121
3.13	Consequences of Theorem 8	135
3.14	Final Remarks	138
3.14.1	Acknowledgements	138
4	Bend Graphs	140
4.1	Introduction	140
4.1.1	The Setup and Definitions	141
4.2	Our Results	142
4.2.1	The Class \mathcal{B}_k	142
4.2.2	The Class $\text{PROPER-}\mathcal{B}_k$	144
Part:	PROOFS FOR RESULTS ON \mathcal{B}_k	144
4.3	The Lower Bounding Argument	145
4.3.1	Idea	145
4.3.2	The target graph	145
4.3.3	k -sets and good k -sets	146
4.3.4	A far enough k -set	148
4.3.5	A lower bounding lemma	150
4.4	Proof of Theorem 9	151
4.5	Proof of Theorem 10	152
4.5.1	Proof of Lemma 16	153
Part:	PROOFS FOR RESULTS ON $\text{PROPER-}\mathcal{B}_k$	157
4.6	The Lower Bound	157
4.7	The Upper Bound Construction	160
4.7.1	Proof of Lemma 17	160
4.8	Final Remarks	165
4.8.1	A Digression from our Theme	165
4.8.2	Acknowledgements	165
5	Interplay	166
5.1	Introduction	166
5.2	Coloring 1-string graphs	166
5.2.1	Notations	168
5.3	A proof of Theorem 12	168
5.3.1	The elegant setup of Kostochka and Nešetřil	168
5.3.2	An almost similar second step	169
	Bibliography	173

Preface

We follow the philosophy of the book “Graphs and Geometry” [Lov19] by László Lovász: *geometric representation is not merely a way to visualize the graph, but an important mathematical tool.*

We focus on two such geometric representations: *arrangements* and *intersection representations*. In particular, we study graphs naturally arising from these geometric representations, namely *arrangement graphs* and *intersection graphs*.

Intersection graph theory and *arrangements* have grown into well-developed subfields of geometric graph theory. For instance, see the book “Topics in Intersection Graph Theory” [MM99] by McKee and McMorris, and the book “Geometric Graphs and Arrangements” [Fel04] by Felsner. Here, we further restrict our study of arrangement graphs and intersection graphs arising from arrangements of curves in the Euclidean plane \mathbb{R}^2 .

For a sample of more work on geometric representations, see the theses [Aer15, Dan10, Der17].

A note on style: This thesis is written keeping an online viewing in mind. To fully utilize these features, one does need the ‘back’ button in the pdf viewer. For Adobe PDF reader, right-click on the toolbar and select ‘Show Page Navigation Tools > Previous View’. For linux based evince reader, right-click on the toolbar and drag the ‘Back’ symbol to the toolbar.

A Recurring Theme

The recurring theme of this thesis hides in Lovász’s use of the term *geometric representation* in his book “Graphs and Geometry” [Lov19]. To demonstrate, we use two standard terms in graph drawing — *geometric graph*: graph drawn in the plane with straight edges, as opposed to *topological graph*: graph drawn in the plane with non-intersecting Jordan curves. This illustrates that curves are *topological* objects, and straight lines or line-segments are *geometric* objects. We found it much easier to study the arrangement graphs and intersection graphs of geometric objects like lines, line segments, etc., and then extend them to their topological analogues. Hence, the central theme of this thesis is to *extend geometric arguments to topological arguments*.

We cannot extend all geometric arguments to topological ones, but for our chosen problems, we could find arguments that do. Also, we do not mean that the topological analogues of problems are always harder than their geometric variant. Problems that exploit the freedom of curves, as opposed to straight lines, would definitely be easier to solve in the topological variant. For example, given a planar graph, it is easier to draw a topological planar drawing than a straight-line planar drawing. But for the problems addressed in this thesis, the geometric variants are relatively easier to solve. However, the insight got while solving them allows us to solve the topological variants as well. This is our takeaway message.

Preliminaries

In an effort to make this thesis almost self-contained, we begin with the following preliminary definitions. Almost all of them are available from the standard texts of graph theory [Wes01] and geometry [Mat02]. For details on computational complexity please refer the standard textbook of Garey and Johnson [GJ79] and the paper by Schaefer [Sch09].

Sets: A *set* is a collection of well-defined objects. The *Cartesian product* of two sets A and B is the set $A \times B$ of all ordered pairs (a, b) such that $a \in A$ and $b \in B$. A *binary relation* R from set A to B is a subset of the Cartesian product $A \times B$. We write aRb if $(a, b) \in R$. When $A = B$ and $R \subseteq A \times A$, we write R is a *binary relation on* A . Two elements $a_1, a_2 \in A$ are *comparable* with respect to a binary relation R if either a_1Ra_2 or a_2Ra_1 . Else, they are *incomparable*. A binary relation R on A is *acyclic* if for all $a_1, a_2, \dots, a_n \in A$, we have $a_1Ra_2, a_2Ra_3, \dots, a_{n-1}Ra_n$ imply a_1Ra_n .

A relation R on a set A is *irreflexive* if for no $a \in A$ does aRa hold. A relation R on a set A is *anti-symmetric* if for $a, b \in A$, aRb and bRa implies $a = b$. A relation R on a set A is *transitive* if for $a, b, c \in A$, aRb and bRc implies aRc . A (strict) *partial order* is irreflexive, anti-symmetric and transitive. A *partially ordered set*, in short *poset* $(P, <)$, is a set P taken with a partial order $<$ on it.

Basic Graph Theory: A *graph* G is a triple consisting of a vertex set $V(G)$, an edge set $E(G)$, and a relation that associates with each edge two vertices called its endpoints. A *loop* is an edge whose endpoints are equal. *Multiple edges* are edges that have the same pair of endpoints. A *simple graph* has no loops or multiple edges. Else, it is called as a *multigraph*¹. The vertices adjacent to a vertex v in a graph G are called the *neighbours* of v . The *degree* of v is the number of its neighbours in G .

¹In this thesis, we shall mostly consider simple graphs, and the rare instances of multigraphs will be loopless.

A *clique* in G is a set of pairwise adjacent vertices. An *independent set* in G is a set of pairwise non-adjacent vertices.

A graph G is *bipartite* if $V(G)$ is the union of two disjoint independent sets.

A *path* P_n on n vertices is a simple graph with vertex set $\{v_1, v_2, \dots, v_n\}$ and edge set $\{v_i v_{i+1} \mid i = 1 \text{ to } n - 1\}$. A u, v -*path* in G is a path from u to v , where $u, v \in V(G)$. A *cycle* C_n on n vertices is a simple graph with vertex set $\{v_1, v_2, \dots, v_n\}$ and edge set $\{v_1 v_n\} \cup \{v_i v_{i+1} \mid i = 1 \text{ to } n - 1\}$. A *complete graph* K_n on n vertices is a simple graph with pairwise adjacent vertices. A *star* on $n + 1$ vertices is a simple graph with vertex set $\{v_0, v_1, v_2, \dots, v_n\}$ and edge set $\{v_0 v_i \mid i = 1 \text{ to } n\}$. A *forest* is a graph containing no cycles.

A graph is *connected* if for every $u, v \in V(G)$ there is a u, v -path. A graph is k -*connected* if it has at least k vertices and remains connected upon removing less than k vertices. A *tree* is a connected graph containing no cycles. A *Halin graph* is obtained by connecting all the leaves of a tree into a cycle.

A *subgraph* of a graph G is a graph H such that $V(H) \subseteq V(G)$ and every edge in H is also in G . An *induced subgraph* of G is obtained by deleting a set of vertices and their incident edges. A *spanning subgraph* of G is a subgraph with vertex set $V(G)$. A *Hamiltonian graph* is a graph with a spanning cycle. A *Hamiltonian path* is a spanning path. A graph G is k -*degenerate* if every subgraph of G has a vertex with degree at most k . The *girth* of a graph is the length of its shortest cycle. For acyclic graphs, the girth is infinite.

Two graphs G_1 and G_2 are *isomorphic* if there is a bijection $f : V(G_1) \rightarrow V(G_2)$ such that uv is an edge in G_1 if and only if $f(u)f(v)$ is an edge in G_2 .

A *subdivision of an edge* uv in graph G is obtained by replacing the edge uv by two edges uw and wv . A *full subdivision* of a graph G is obtained by subdividing each of its edge exactly once.

Coloring: A *proper k -coloring* of a graph G is a labeling $f : V(G) \rightarrow [k]^2$ such that adjacent vertices have different labels. A graph is k -*colorable* if it has a proper k -coloring. The *chromatic number* $\chi(G)$ is the least k such that G is k -colorable. If $\chi(H) < \chi(G)$ for every proper subgraph H of G , then G is *color-critical*.

A *proper k -edge-coloring* of a graph G is a labeling $f : E(G) \rightarrow [k]$ such

² $[k] = \{1, 2, \dots, k\}$.

that edges incident at the same vertex have different labels. A graph is *k-edge-colorable* if it has a proper *k*-edge-coloring.

Basic Topological Definitions: A *curve* is the image of a continuous function $\gamma : [0, 1] \rightarrow \mathbb{R}^2$. The points $\gamma(0)$ and $\gamma(1)$ are called its *endpoints*. A curve is *closed* if $\gamma(0) = \gamma(1)$. A curve is *simple* if it does not self-intersect (except possibly $\gamma(0)$ and $\gamma(1)$ when it is closed). For two points $x, y \in \mathbb{R}^2$, a curve is called a *x, y-curve* if $x = \gamma(0)$ and $y = \gamma(1)$. A curve is *x-monotone* if any two points in it do not have the same X-coordinate (for a specified standard axis system).

An *open set* in the plane is a set $S \subset \mathbb{R}^2$ such that for every $p \in S$, there exists a small number $\epsilon > 0$ such that all points within ϵ distance from p belongs to S .

A set is *arcwise-connected* if for any pair of points $x, y \in S$, there is a *x, y-curve* in S . We do not make any distinction with pathwise-connected sets as we deal with Euclidean spaces where these notions are equivalent. A set S is *convex* if for every pair of points $x, y \in S$, the *x, y-linear curve* (line segment) is in S .

A *homeomorphism* between two topological spaces is a continuous function that has a continuous inverse. For example, a curve is homeomorphic to a line-segment/interval.

Planar Graphs: A *drawing* of a graph G is the image of $f : V(G) \cup E(G) \rightarrow \mathbb{R}^2$ such that $f(v) \in \mathbb{R}^2$ for each $v \in V(G)$, and $f(e)$ is a *f(u), f(v)-curve* for $e = uv \in E(G)$ such that the images of vertices are distinct, and if $f(u) \in f(e)$ then $f(u)$ is an endpoint of $f(e)$.

A point $f(e) \cap f(e')$ that is not a common endpoint is a *crossing*. A crossing-free drawing of a graph G is called a *planar embedding* of G . Then G is a *planar graph*. A planar graph along with a particular planar embedding is called a *plane graph*. The *faces* of a plane graph are the maximal arcwise-connected regions of the plane that contains no points used in the embedding.

For a connected plane graph on n vertices, e edges and f faces, the *Euler's formula* states that

$$n - e + f = 2.$$

A planar graph G is called an *outerplanar graph* if G has a planar embedding such that all the vertices lie in the unbounded face.

1 Introduction

Contents

1.1	Arrangements of Curves	9
1.1.1	Some Interesting Connections of Arrangements	11
1.1.2	History and Motivation	13
1.1.3	Natural Sources of Graphs	15
1.2	Pseudoline Arrangement Graphs	18
1.2.1	The Pseudoline Arrangement Graph Realization Problem	20
1.2.2	Eccentricities in Pseudoline Arrangement Graphs	21
1.3	String Graphs	25
1.3.1	Subclasses of interest	28
1.3.2	Coloring 1-string graphs	30
1.4	Bend Graphs	33
1.4.1	EPG Graphs	35
1.4.2	VPG Graphs	37
1.5	The Coloring Question of Kostochka and Nešetřil	41
1.6	Organization of the Thesis	42
1.7	Final Remarks	44

1.1 Arrangements of Curves

Arrangements are basic objects of study in *Discrete and Computational Geometry*. Traditionally, an arrangement of a set of geometric objects S is defined as a subdivision of the ambient space into connected regions induced by S . We use the following simpler definition. Given a set of geometric objects S its *arrangement* $\mathcal{A}(S)$ is the *embedding*¹ of S in an *ambient plane*. Throughout this thesis, we consider the ambient plane to be the Euclidean plane \mathbb{R}^2 . The two most popular and well-studied examples of arrangements are the *line arrangements* and *pseudoline arrangements* (see Chapters 5 and 6 of the book “Geometric Graphs and Arrangements” [Fel04] by Felsner; also see the

¹An embedding is a continuous function which is a homeomorphism onto its image.

chapter [FG17] on pseudolines, and the references therein, by Felsner and Goodman in the “Handbook of Discrete and Computational Geometry”).

We begin with the easiest definition. A *line* is a linear curve that extends to infinity in both ends. A *pseudoline* is a curve that extends to infinity in both the ends such that two pseudolines can intersect at most once where they cross each other. A pseudoline is the topological analogue of a line. A *line arrangement* in the Euclidean plane \mathbb{R}^2 is a collection of (at least three) lines. A *pseudoline arrangement* $\mathcal{A}(L)$ in the Euclidean plane \mathbb{R}^2 is a collection L of (at least three) pseudolines. These arrangements are *simple* if no three lines/pseudolines meet at a point and there are no parallel lines/pseudolines. Thus each pair of lines/pseudolines intersect exactly once where they *cross* each other.

To build general arrangements, we need finite geometric objects. A (*line*) *segment* is a continuous finite part of a line bounded by two points in it. Similarly, a *pseudosegment* is a continuous finite part of a pseudoline bounded by two points in it such that two pseudosegments can intersect at most once where they cross each other. A pseudosegment is a topological analogue of a segment. An *arrangement of segments* in \mathbb{R}^2 is a collection of (line) segments in \mathbb{R}^2 . An *arrangement of pseudosegments* in \mathbb{R}^2 is a collection of pseudosegments in \mathbb{R}^2 . A more general definition is that of an *arrangement of finite curves* in \mathbb{R}^2 , which is a collection of finite curves in \mathbb{R}^2 where the curves cross at their intersection points (two finite curves are allowed to intersect multiple times).

Following the theme of this thesis, the line arrangements and arrangements of segments are *geometric* in nature. Whereas the pseudolines arrangements and arrangements of pseudosegments are their corresponding *topological* analogues.

Pseudoline arrangements naturally generalize line arrangements and preserve their basic topological and combinatorial properties. It is well-known that pseudoline arrangements strictly contain line arrangements (see Levi [Lev26] and Ringel [Rin56, Rin57]). Such arrangements are called *non-stretchable* (see Figure 1.1). Similarly, arrangements of pseudosegments naturally generalize arrangements of segments and preserve their basic topological and combinatorial properties. The above separating example also shows

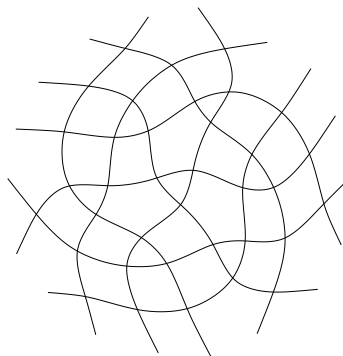

Figure 1.1: A non-stretchable simple pseudoline arrangement

the strict containment of arrangements of segments in arrangements of pseudosegments.

First, let us see some applications/connections of these arrangements to different problems. We focus on the theoretical ones. For details on the practical applications, one can see the survey by Agarwal and Sharir [AS00, §14].

1.1.1 Some Interesting Connections of Arrangements

Since arrangements occur naturally in geometric and topological settings, one expects them to play a fundamental role in dealing with problems in these settings. First, we look into three ‘easy looking’ problems that make use of arrangements. The first two problems were posed in a paper of Erdős [Erd46] in 1946.

The first is the *Erdős distinct distances problem*, which asks how many distinct distances are determined by n points. Erdős [Erd46] obtained an asymptotic lower bound of \sqrt{n} . We present an alternate proof given in Garibaldi, Iosevic, and Senger [GIS11]. Fix two points p and q . Consider the arrangement of circles such that (1) each circle is either centered at p or q and (2) each of the left $n - 2$ points is an intersection point between two circles, one centered at p and the other at q . Let there be s circles centered at p and t circles centered at q . Then the total number of intersection points is at most $2st$. Thus $n - 2 \leq 2st$. Hence, at least one of s or t is asymptotically at least \sqrt{n} . This proves the result of Erdős. The journey of improvements on this problem is well-documented in the book of Garibaldi, Iosevic, and Senger [GIS11].

The second problem that we discuss is the *Erdős unit distance problem*, which asks for the maximum number of times that the unit distance can occur

among n points in the plane. This can be formulated as an incidence problem by a multiplicative factor of two: what is the maximum number of point-circle incidences among n points and n unit circles? It turns out that the combinatorial bounds obtained for arrangements of pseudosegments are tighter than the case of arrangements of finite curves when two curves are allowed to intersect more than once. Using this idea, Aronov and Sharir [AS02] cut the circles into fewer pseudosegments to obtain better bounds. This bound is then related to point-circle incidences. This technique has been fruitfully used for over two decades and has recently led to a breakthrough for breaking the ‘3/2 barrier’ for unit distances in three dimensions (see Zahl [Zah19]).

The above two problems are related: the maximum number of times the unit distance can occur among n points times the minimum number of distinct distances times is at least $\binom{n}{2}$. Hence an upper bound on the Erdős unit distance problem implies a lower bound on the Erdős distinct distances problem.

The third problem we discuss is the famous *Sylvester-Gallai theorem*. It states that given n points in the plane, not all colinear, there exists an *ordinary line*: a line that passes through exactly two points. The textbook proof, using the pair (p, l) where the point p has the minimum distance from l among all such point-line pairs, is one of the gems in combinatorial geometry. The Dirac-Motzkin conjecture asks to prove the existence of $n/2$ ordinary lines. Melchior [Mel40] was the first to prove the existence of more than one ordinary line. He considered the dual problem: in an arrangement of n lines, show that there is an *ordinary point*. Using Euler’s formula and some simple counting techniques, he proved the existence of three ordinary points. This problem shows the utility of arrangements: using duality one can study problems on the configuration of points and lines. For more details on the duality, see Felsner [Fel04] (and Matoušek [Mat02]). And for the latest survey on the progress on Dirac-Motzkin conjecture see Green and Tao [GT13].

Next, we discuss two connections of the “envelopes” of arrangements with two other problems. The first is on the Davenport-Schinzel sequence. Informally, a (n, s) *Davenport-Schinzel sequence* is a string composed of n symbols free from consecutive occurrences of the same symbol and free from occurrences of alternating instances of two symbols of length $s+2$. These sequences turn out to have a correspondence with the lower envelopes of arrangements

of n real continuous functions defined on the real line with the restriction that each pair of functions intersect at most s times. We do not go into much details: see the book by Sharir and Agarwal [SA95].

The second such connection is with k -center problems. In a k -center problem, the objective is to place k facilities in a graph/metric space such that the maximum distance of any point in the graph/metric space to its nearest facility is minimized. The idea of *line arrangement searching* is used in solving k -center problems (see Wang and Zhang [WZ21]). In particular, for studying the weighted k -center problem for paths, the structure of line arrangements is heavily used.

Finally, we discuss the natural connection between arrangements and crossing numbers (see Arroyo, Bensmail, and Richter [ABR20]). A rectilinear drawing of a graph has edges as segments, whereas a pseudolinear drawing of a graph has edges as pseudosegments (recall that two pseudosegments intersect at most once). For a graph G the minimum number of pairwise edge crossings of each type of these drawings are called rectilinear crossing number and pseudolinear crossing number, respectively. Pseudolinear drawings are well-studied as they are a natural generalization of rectilinear drawings. Hence, many of the results on rectilinear drawings naturally extend to pseudolinear drawings. For example, the proof of the well-known (see [Mat02]) lower bound of rectilinear crossing number of K_n , that is,

$$H(n) := \frac{1}{4} \left\lfloor \frac{n}{2} \right\rfloor \left\lfloor \frac{n-1}{2} \right\rfloor \left\lfloor \frac{n-2}{2} \right\rfloor \left\lfloor \frac{n-3}{2} \right\rfloor$$

also holds for the pseudolinear crossing number.

1.1.2 History and Motivation

History

Recall that the line arrangements and, their topological analogues, pseudoline arrangements are the most well-studied examples of arrangements. Next, we briefly survey some known results on these two classes of arrangements.

The earliest record on line arrangements is perhaps in 1826 due to Steiner [Ste26]. He begins with a problem that is today known as the *lazy caterer's sequence*, which asks for the maximum number of faces in a plane

made by n straight lines. Then he goes on to find the same under various restrictions of lines and circles, and then to find the maximum number of 3-dimensional cells formed by planes and spheres in \mathbb{R}^3 . Levi [Lev26] introduced pseudoline arrangements in 1926. However, it was the survey book by Grünbaum [Grü72] and, later, the topological representation theorem of Folkman and Lawrence [FL78] (amongst others) that have driven research in this field in the last five decades.

The question on the enumeration of non-isomorphic pseudoline arrangements by Knuth has produced a series of rich results by Knuth [Knu92], Felsner [Fel97], Felsner and Valtr [FV11], and Dumitrescu and Mandal [DM20]. Another interesting combinatorial question asks to find the number of triangles in line arrangements. This has been studied by Melchior [Mel40], Levi [Lev26], Füredi and Palsti [FP84], Felsner and Kriegel [FK99], and others. A question regarding the computational complexity aspect of pseudoline arrangements concerns *stretchability*: given a pseudoline arrangement, decide whether it is isomorphic to a line arrangement. This was proved to be NP-hard by Shor [Sho91], and $\exists\mathbb{R}$ -hard by Schaefer [Sch09] (also follows from the arguments of Mnev [Mne88]).

For further details on line and pseudoline arrangements, see the surveys by Grünbaum [Grü72], by Erdős and Purdy [EP95], and the latest survey by Felsner and Goodman [FG17]; also see the book by Felsner [Fel04, Chap. 5 and 6]. Grünbaum [Grü72] (in the 1970s) was the first to collect relevant results and posed many problems and conjectures on arrangements of lines as well as pseudolines. The chapter by Erdős and Purdy [EP95] also addresses various aspects of arrangements. The survey by Felsner and Goodman [FG17] is the most recent (2017). Chapter 5 in Felsner's book [Fel04] contains results on line arrangements, whereas pseudoline arrangements are studied in Chapter 6. Algorithms on arrangements are addressed in the book [Ede87] by Edelsbrunner (also see the book by Matoušek [Mat02, Chap. 6]).

Motivation

Two of the main reasons driving the study of pseudoline arrangements are as follows.

- **Grünbaum's book "Arrangements and Spreads":** Before the

book [Grü72] by Grünbaum (in 1972) there were a few papers on line and pseudoline arrangements. Much of the research in combinatorial aspects of line arrangement and pseudoline arrangements have originated from the (40+) conjectures given in this book. It is a prime example of how a good exposition can drastically change the amount of research in a field.

- **Topological Representation Theorem:** The topological representation theorem of Folkman and Lawrence [FL78] implies that oriented matroids differ from rectilinear geometry by a topological deformation. The theorem identifies the oriented matroids of rank three with arrangements of pseudolines (in the projective plane). This equivalence allows a good point of view for various results on oriented matroids of rank three. For details see Chapter 6 of the bible of oriented matroids by Björner et al. [BLS⁺99].

1.1.3 Natural Sources of Graphs

Arrangements of curves are natural sources of graphs. We shall discuss two such graph classes. The first graph class is obtained due to the embedding of the curves in the ambient plane. Let us be more precise. One can safely assume that two curves intersect in a finite number of points (this can be obtained by contracting the overlapping parts of two strings to a point). The *arrangement graph* arising from an arrangement of curves has vertices as intersection points between the curves in the arrangement, and edges as parts of the curves that connect two vertices, with no vertex between them². The part of the arrangement of curves that form the vertices and edges of an arrangement graph is called the *arrangement realization* of the graph.

The first obvious observation is that arrangement graphs of curves are planar graphs (or multigraphs): their realization is a plane graph (multigraph). Another easy observation is that the arrangement graphs of pseudosegments are precisely the planar graphs. We just proved one direction. To see the other direction, consider a plane graph. Extend each edge a bit on each of its endpoints to take care of the crossing restriction. Treat each extended edge in

²We want to highlight that according to our definition the end points of finite curves are vertices only if they are intersection points.

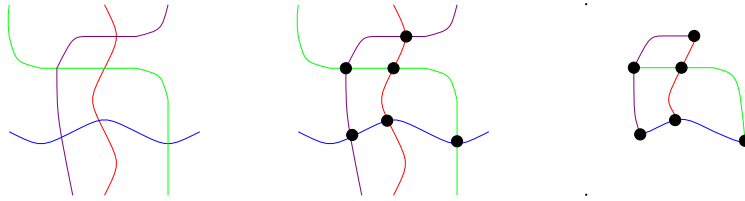

Figure 1.2: Pseudoline arrangement graph on four pseudolines

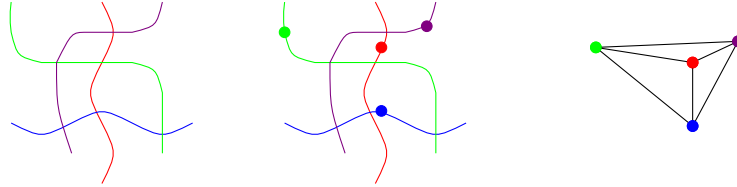

Figure 1.3: Intersection graph on four pseudolines

the drawing as a pseudosegment. Now consider the arrangement graph from the resulting arrangement of pseudosegments. This is precisely the planar graph we started with. Similarly, with arrangements of finite curves, we get all possible planar multigraphs.

To make things interesting, we put further restrictions on the curves. The next two types of arrangement graphs are the most studied. A *line arrangement graph* is obtained from a *simple* line arrangement, that is, an arrangement of lines with every pair of lines intersecting and no three lines intersecting at a point. Similarly a *pseudoline arrangement graph* is obtained from a simple pseudoline arrangement (see Figure 1.2). Using non-stretchable pseudoline arrangements, one can see that the class of pseudoline arrangement graphs strictly contain the class of line arrangement graphs.

Our second graph class is the intersection graphs of curves, more popularly known as *string graphs*. Here the curves (also called strings) are represented by vertices and pairwise intersecting curves denote adjacency between the corresponding vertices (see Figure 1.3). String graphs are well-studied, since their formal introduction to the graph theory community by Ehrlich, Even, and Tarjan [EET76].

A Natural Connection

There is a natural connection between these two graph classes which was formally explored by Kostochka and Nešetřil [KN98]. We describe the connection via a simpler example. Consider the arrangement graph and intersection

graph induced by a simple pseudoline arrangement on n pseudolines. This is a simple example as the intersection graph is a complete graph. But it serves our purpose. See [Figure 1.2](#) and [1.3](#).

The intersection points in the pseudoline arrangement correspond to vertices in the arrangement graph and edges in the intersection graph. Since there is exactly one intersection point between a pair of pseudolines, the number of vertices in the arrangement graph is the same as the number of edges in the intersection graph. Another observation is the following. Consider a pseudoline in the arrangement. The line contains $n-1$ intersection points and $n-2$ edges of the arrangement graph. Thus the degree of the corresponding vertex in the intersection graph is $n-1$: one more than the number of edges the pseudoline has in the arrangement graph. Let $G_{\mathcal{A}}$ and $G_{\mathcal{J}}$ represent the arrangement graph and intersection graph. Then, we have the following equations. Let d_i denote the degree of the vertex v_i , for $i = 1$ to n .

$$|V(G_{\mathcal{A}})| = |E(G_{\mathcal{J}})|,$$

$$|E(G_{\mathcal{A}})| = \sum_{i=1}^{|V(G_{\mathcal{J}})|} (d_i - 1) = \sum_{i=1}^{|V(G_{\mathcal{J}})|} d_i - |V(G_{\mathcal{J}})| = 2|E(G_{\mathcal{J}})| - |V(G_{\mathcal{J}})|.$$

The connection shown by Kostochka and Nešetřil [[KN98](#)] holds for a more general arrangement of curves that we shall see in [Chapter 5](#).

In the rest of this chapter, we motivate and present our results on arrangement graphs and intersection graphs of curves.

Part: ARRANGEMENT GRAPHS

Among arrangement graphs, we primarily study *line arrangement graphs* and *pseudoline arrangement graphs* (topic of [Chapter 2](#)). We start by explicitly stating their definitions.

1.2 Pseudoline Arrangement Graphs

The class of *line arrangement graphs* $\mathcal{G}_{\mathcal{L}}$ are graphs induced by simple arrangements $\mathcal{A}(L)$, for any set of lines L , whose vertices are intersection points of lines in L , and there is an edge between two vertices if they appear on one of the lines, say $l \in L$, with no other vertices in the part of l between the two vertices. The realization of a line arrangement graph G_L by lines in L is its *line arrangement realization* $R(G_L)$. We get a line arrangement realization from its corresponding line arrangement by deleting the two infinite segments of each line.

We have analogous definitions by replacing lines with pseudolines. The class of *pseudoline arrangement graphs* $\mathcal{G}_{\mathcal{L}}$ are graphs induced by simple arrangements $\mathcal{A}(L)$, for any set of pseudolines L , whose vertices are intersection points of pseudolines in L , and there is an edge between two vertices if they appear on one of the pseudolines, say $l \in L$, with no other vertices in the part of l between the two vertices. The realization of a pseudoline arrangement graph G_L by pseudolines in L is its *pseudoline arrangement realization* $R(G_L)$. We get a pseudoline arrangement realization from its corresponding pseudoline arrangement by deleting the two infinite segments of each pseudoline.

It is interesting to note that realizations of both the graphs are unique up to isomorphism. First, Bose, Everett, and Wismath [[BEW03](#)] proved this for line arrangement graphs. Later, Eppstein [[Epp14](#)] extended this result to show the uniqueness of pseudoline arrangement realization (up to isomorphism).

We saw earlier that pseudoline arrangements naturally generalize line arrangements, preserving their basic topological and combinatorial properties. Also, pseudoline arrangements strictly contain line arrangements (see [[Fel04](#)]). This relation is inherited by their corresponding graph classes.

The problems addressing line and pseudoline arrangement graphs are graph-theoretic, and their proofs have a geometric and topological flavor, respectively. As expected, our results hold for both the graph classes — they do not depend on the *straightness* of the lines. As a result, we focus on the general class: pseudoline arrangement graphs, highlighting only the differences. (In contrast, the computational complexities differ for their corresponding recognition problems: NP-hard for line arrangement graphs by Bose, Everett, and Wismath [BEW03], and linear-time for pseudoline arrangement graphs by Eppstein [Epp14].)

Next, we want to highlight an elegant solution to 3-colorability of both line arrangement graphs and pseudoline arrangement graphs. First, we prove it for line arrangement graphs. Consider its line arrangement realization. Rotate the realization, if necessary, such that none of the lines are vertical. Now we color the vertices greedily as we scan them from left to right. Notice that each vertex has at most two neighbours that are colored. Thus, we can assign the third color to it, resulting in a 3-coloring of the graph. Moreover, we cannot do better, as a triangle is also a line arrangement graph. To extend this result to pseudoline arrangement graphs, we just need to show that there is a realization of these graphs with x -monotone pseudolines. This is exactly what *wiring diagrams* are (see Section 2.3 for details).

Bose, Everett, and Wismath [BEW03] introduced the notion of a line arrangement graph in *EuroCG*, 1998. This graph definition almost resembles the one given by Eu, Grévremont and Toussaint [EGT96], who gave an efficient algorithm for finding the envelope of a line arrangement, that is, the outer face of the line arrangement realization. Amongst other results, Bose, Everett, and Wismath gave examples of non-Hamiltonian line arrangement graphs.

Soon Felsner et al. [FHN⁺06] showed pseudoline arrangement graphs are 4-edge-colorable and 3-vertex-colorable. They also studied corresponding graphs got from other ambient spaces. They showed that projective pseudoline arrangement graphs are 4-connected and 4-vertex-colorable, and when the number of pseudolines is odd, they can decompose into two edge-disjoint Hamiltonian paths. They also showed that *circle arrangement graphs* (great circles on a sphere) are 4-connected, 4-edge-colorable and 4-vertex-colorable,

and their generalization, *pseudocircle arrangement graphs*, decompose into two edge-disjoint Hamiltonian cycles. Eppstein [Epp14] gave a linear-time algorithm to draw a (pseudo) line arrangement graph in a grid of area $O(n^{7/6})$.

We discuss two types of problems in this part: one is based on degree sequences, and the other on eccentricities of vertices.

1.2.1 The Pseudoline Arrangement Graph Realization Problem

First, we need the following standard definitions. The *degree sequence* of a graph is the non-increasing list of degrees of its vertices. If a graph has degree sequence π , we say that G is a *realization* of π . Given an arbitrary finite sequence of non-increasing numbers π , the *graph realization problem* asks whether a graph realizes π . Researchers have studied this classical problem from graph theory for the past six decades. The Erdős-Gallai theorem [EG60] and the Havel-Hakimi algorithm [Hav55, Hak62] (strengthening of the former) are two popular methods to solve the graph realization problem.

Next, we are ready to explicitly state the problem that we address.

Pseudoline Arrangement Graph Realization Problem. Given a sequence of finite numbers π , whether there is a pseudoline arrangement graph with degree sequence π .

We solve this problem in [Chapter 2](#). Here we state the theorem. For an affirmative answer, we also construct a (pseudo) line arrangement realization.

A vertex with degree i is an i -vertex, for $2 \leq i \leq 4$; let d_i denote the number of i -vertices. Let $\langle a_1^{d_1}, a_2^{d_2}, \dots, a_k^{d_k} \rangle$ denote the sequence $\langle a_1, \dots, a_1, a_2, \dots, a_2, \dots, a_k, \dots, a_k \rangle$ of d_i many a_i 's, for $i = 1$ to k .

Theorem 1. *A finite non-increasing sequence of positive numbers π is a degree sequence of a (line arrangement graph) pseudoline arrangement graph if and only if it satisfies the following two conditions.*

1. $\pi = \langle 4^{d_4}, 3^{d_3}, 2^{d_2} \rangle$ with $3 \leq d_2 \leq n$, $d_3 = 2(n - d_2)$ and $d_4 = n(n - 5)/2 + d_2$ for some integer $n \geq 3$.
2. If $d_2 = n$, then n is odd.

We shall see in [Chapter 2](#) that [Theorem 1](#) is in some sense the best one can hope for in terms of information obtained from degree sequences. Further, [Theorem 1](#) also implies that pseudoline arrangement graphs do not have a *forbidden graph characterization*, that is a characterization for recognizing a graph class by specifying a list of graphs that are forbidden to exist as (or precisely, be isomorphic to) an induced subgraph of any graph in the class. More details on these are given in [Chapter 2](#).

1.2.2 Eccentricities in Pseudoline Arrangement Graphs

First, we start with some preliminary definitions. The *distance* $d(u, v)$ between two vertices u, v of a graph G is the length of the shortest path between them. The *eccentricity* $e(u)$ of a vertex u is the maximum distance of a vertex in $V(G)$ from u . A vertex v is an *eccentric vertex* of u if $d(u, v) = e(u)$. The *diameter* $d(G)$ of G is the maximum eccentricity of any vertex in $V(G)$. A vertex u is *diametrical* if $e(u) = d(G)$. The *radius* $r(G)$ of G is the minimum eccentricity of any vertex in $V(G)$. A vertex u is *central* if $e(u) = r(G)$.

Recall that Bose, Everett, and Wismath [[BEW03](#)] were the first to introduce line arrangement graphs and its definition resembles the one given by Eu, Grévremont and Toussaint [[EGT96](#)] who gave an efficient algorithm for finding the envelope of a line arrangement. This problem was studied by Ching and Lee [[CL85](#)] in 1985. However, their focus was on finding the Euclidean diameter of a line arrangement. In this part, we study the graph-theoretic analogues of these classic computational geometry problems. First, we begin this part in [Chapter 2](#) with some basic observations regarding the properties of shortest paths and eccentric vertices. Using these observations, we study the diameter of pseudoline arrangement graphs.

Proposition 1. *The diameter of a pseudoline arrangement graph on n pseudolines is $n - 2$.*

Surprisingly, the diameter of a pseudoline arrangement graph is independent of the graph and depends only on the number of pseudolines in its realization.

Next, we characterize the vertices in the ‘envelope’ in terms of eccentricity.

Theorem 2. *A vertex v in a pseudoline arrangement graph G is a diametrical vertex if and only if v lies in the outer face of its realization $R(G)$.*

This is the first step in finding the radius of pseudoline arrangement graphs. Our central idea is to prove that as we move to the interior of the pseudoline arrangement realization, after iteratively removing the outer layer of vertices, one would expect the eccentricity of vertices in the inner layers to decrease. The proof of [Theorem 2](#) is given in [Chapter 2](#).

Next, we study intersection graphs of curves.

Part: INTERSECTION GRAPHS

We begin the study of *intersection graphs* of curves from this part onwards. First, we start with a general definition. The *intersection graph* of a family of sets \mathcal{F} is the graph, denoted by $\Omega(\mathcal{F})$, with vertex set \mathcal{F} and edge set $\{XY \mid X, Y \in \mathcal{F}, X \neq Y, X \cap Y \neq \emptyset\}$. A graph G is an *intersection graph* if there exists some family of sets \mathcal{F} such that G is isomorphic to $\Omega(\mathcal{F})$. Here \mathcal{F} is known as the *intersection representation* of the graph G . When we say a graph is an intersection graph of a family of sets, we mean that the graph is isomorphic to an intersection graph of a family of sets.

In the last five decades, research in intersection graphs has undergone rapid expansion, to the point of forming a new subfield of graph theory (see the book by McKee and Morris [MM99] that contains general results before 2000). This is, in part, due to their numerous practical applications in: datamining, modeling broadcast networks, scheduling, genetics, matrices, statistics, psychology etc. (see the book [MM99]).

It is a very old result of Marczewski [Mar45] that every graph is an intersection graph. In fact, every graph is an intersection graph of the family of (vertex sets of) stars centered at each vertex of the graph. This implies that for every graph G there is a family \mathcal{F} of sets such that G is isomorphic to $\Omega(\mathcal{F})$, that is, $G \cong \Omega(\mathcal{F})$. To make things interesting, we put restrictions on G and \mathcal{F} . The general template of problems here is as follows. Let \mathcal{G} be a set of graphs and Σ be a set of sets. We say $\mathcal{G} \cong \Omega(\Sigma)$ if each graph $G \in \mathcal{G}$ is isomorphic to an intersection graph $\Omega(\mathcal{F})$ for some family \mathcal{F} of sets from Σ , and each $\Omega(\mathcal{F})$ for a family \mathcal{F} of sets from Σ is isomorphic to a graph $G \in \mathcal{G}$. Find graph classes \mathcal{G} where one can find a Σ such that $\mathcal{G} \cong \Omega(\Sigma)$? A classical example is the class of chordal graphs where Σ is the set of all subtrees of a tree.

Geometric Intersection Graphs

Our focus is when Σ is a set of geometrical objects³. Even under these restrictions, one has to choose the geometrical objects carefully. An old result of Tietze [Tie05] implies that every graph is an intersection graph of 3-dimensional polytopes⁴. Nevertheless, many interesting classes of graphs arise under these restrictions. The most popular and widely applicable one is perhaps the *interval graphs*: intersection graphs of closed intervals on the real line. Many natural kinds of generalization of interval graphs are well-studied.

1. Considering an interval as the set of points in an ambient space (line in this case) that are within some distance from a point, we can generalize interval graphs by varying the ambient plane; as *disk graphs*: intersection graphs of disks in the plane, and in higher dimensions as intersection graphs of d dimensional *balls* in \mathbb{R}^d . If one restricts the d -balls to have the same radius, then the *sphericity* of a graph is the minimum d such that the graph is an intersection graph of d -balls in \mathbb{R}^d . It is a nice exercise problem to see that the sphericity of a graph is well-defined. In fact, Maehara [Mae84] proved that the sphericity of a graph on n vertices is at most $n-1$. *Unit interval graphs* or equivalently *proper interval graphs* are precisely the graphs with sphericity 1, and *unit disk graphs* are precisely the graphs with sphericity 2.
2. Generalizing an interval to a cartesian product of k intervals, we get a k -box, resulting in the class of intersection graphs of k -boxes. Similarly, generalizing an interval to cartesian products of k intervals of equal length, we get a k -cube, resulting in the class of intersection graphs of k -cubes. The *boxicity* of a graph is the minimum k such that a graph is an intersection graph of k -boxes. The *cubicity* of a graph is the minimum k such that a graph is an intersection graph of k -cubes. Again, it is a nice exercise problem to see that the boxicity and cubicity of a graph are well-defined. In fact, Roberts [Rob69] proved that the boxicity and cubicity of a graph on n vertices is at most $\lfloor n/2 \rfloor$ and $\lfloor 2n/3 \rfloor$, respectively.

³On a side note, Pach [Pac14] shows how the questions on topological graphs have led to the study of intersection graphs of geometric objects.

⁴see Matoušek [Mat02, Chap. 5] for definition.

3. Generalizing intervals to convex sets in higher dimensions, we get intersection graphs of convex sets in the plane, and in 3-dimensions. As mentioned earlier, a consequence of a result of Tietze [Tie05] implies that every graph is an intersection graph of convex polytopes in 3-dimensions. Hence, there is no need for further generalization.
4. Replacing an interval by its homeomorphic image, we get a *segment* if the transformation is linear, or otherwise, we get a *curve* (also called *string*). This results in *segment intersection graphs*⁵: intersection graphs of segments in a plane, and *string graphs*: intersection graphs of strings in a plane.

The class of string graphs and its subclasses is the focus of the rest of this chapter.

1.3 String Graphs

A *curve* or *string* is a homeomorphic image of the interval $[0, 1]$ in the plane. A *string graph* is the intersection graph of a finite collection of strings. This collection of strings is the *string representation* of the string graph.

We can safely assume the following conditions in the string representation: (1) strings are *simple*, that is, non-self-intersecting: else replace the self-intersecting string by a simple one while maintaining the intersections, (2) all the intersection points and ends of strings are distinct: else perturb the strings at the point where this condition is not satisfied, and (3) strings cross at the intersection points: else slightly perturb the representation such that the touching pair of strings now form a pair of intersection points where the strings cross.

String graphs capture all possible intersection of arcwise-connected geometric objects: replace these objects by appropriate *space-filling curves*. Hence, string graphs capture a lot of geometric intersection graphs. In the other direction, Pach, Reed, and Yuditsky [PRY20] proved that almost all string graphs are intersection graphs of plane convex sets. We look at some of its, non-trivial examples followed by some non-examples. See Fox and

⁵On a side note, *stretchability* is used to prove the $\exists\mathbb{R}$ -completeness of segment intersection graphs (see [KM94] and [Sch09]).

Pach [FP10], Matoušek [Mat14] and Kratochvíl [KM91, Kra91a, Kra11] for details on string graphs.

Examples The first non-trivial example of string graphs that we shall discuss are the planar graphs. To see one of their string representation, we extend the idea of proving that all (general) graphs are intersection graphs by representing the vertices of the graph by the stars centered at that vertex. Consider a (straight-line) planar embedding of the graph and at each vertex consider the star centered at the vertex such that each line of the star is just above half of the corresponding edge. The intersection representation obtained by drawing envelopes about these stars (and then removing a point from each) is a 2-string representation of the planar graph. In fact, it is known that planar graphs have a 1-string representation [CGO10] (defined shortly). This result is very non-trivial, which we shall discuss later.

Another non-trivial graph class that can be seen to be string graphs using the previous technique is chordal graphs. As mentioned earlier chordal graphs are intersection graphs of subtrees of trees. The intersection representation obtained by drawing *envelopes* about these subtrees is a string representation of the chordal graph.

Our next example of family of string graphs is the class of *incomparability graphs*. This was proved by Golubic, Rottem and Urrutia [GRU83] and independently by Lovász [Lov83]. Given a POSET $(P, <)$, its incomparability graph is the graph with vertex set P , in which two elements of P are adjacent if and only if they are incomparable. The results of Golubic, Rotem and Urrutia [GRU83], and of Lovász [Lov83] implies that a graph is an incomparability graph if and only if it is the intersection graph of a collection of curves given by continuous functions defined on the interval $[0, 1]$. Fox and Pach [FP12] proved that most string graphs contain huge subgraphs that are incomparability graphs.

Non-Examples Sinden [Sin66] proved that full subdivisions of non-planar graphs are not string graphs. To see this, suppose the full subdivision (obtained by subdividing each edge of the graph) of a non-planar graph G has a string representation, then we can contract the strings representing the vertices of G to points such that no new intersection points are introduced

between two different strings. This can be done by contracting the strings maintaining the ordering of intersection points in these strings till they finally merge to become a single point. The strings representing the vertices introduced during subdividing G form the edges in the embedding, and they intersect no other edges in the embedding (as they are independent). The resulting embedding is a planar representation of G : a contradiction.

This implies that the full subdivision of the complete graph on five vertices is not a string graph. But there are many graphs that contain this 15-vertex graph as an induced subgraph. Using results from extremal graph theory and few known results on hereditary properties of graphs, Pach and Tóth [PT06] proved that there are $2^{\binom{3}{4}+o(1)}\binom{n}{2}$ (labeled) string graphs on n vertices.

Next, we give a brief survey on string graphs.

Survey While studying the topology of genetic structures, Benzer [Ben59] used a concept similar to the string graphs in 1959. A few years later Sinden [Sin66] studied string graphs in the context of ‘printed’ circuits. He proved that not all graphs are string graphs. He also proved that all planar graphs are string graphs. It is now known that all planar graphs are not only 1-string graphs (pair of strings intersect at most once) [CGO10] but also segment graphs (intersection graphs of segments) [CG09] and also L-graphs (intersection graphs of L-shaped rectilinear curves) [GIP18]. As mentioned earlier chordal graphs, incomparability graphs, permutation graphs⁶ etc. are also string graphs.

The problem of recognising string graphs has a very interesting history. It was initially posed by Sinden [Sin66] in 1966, but in the context of *circuit-designing*. Ten years later, Graham introduced string graphs to the mathematical community and posed the question of its characterization. In 1991, Kratochvíl [Kra91b] proved that recognizing string graphs is NP-hard. Around the same time, Kratochvíl and Matoušek [KM91] showed that there are string graphs that need exponential number of intersection points. They conjectured that for any string graph there is a representation, that has at most 2^{cn^k} number of intersections, where c and k are constants. Later, Schaefer and Štefankovič [SŠ04], and Pach and Tóth [PT02] proved decidability of

⁶Permutation graphs are intersection graphs of segments between two parallel lines.

the string graph recognition problem by proving the above conjecture. Soon Schaefer, Sedgwick and Štefankovič [SSŠ03] proved that the string graph recognition problem is in NP. Combining it with the NP-hardness result of Kratochvíl [Kra91b] implies that the string graph recognition problem is NP-complete.

Before moving on to discussing our problem, we discuss some motivations of string graphs.

Motivations First, we present the motivation of Benzer [Ben59]. His objective was to find the arrangement of sub-elements in the *genes*. It was observed earlier that looking at the quantitative aspects of this question did not make sense, hence the need of a qualitative point of view. Benzer initiated the idea of looking at this question from the viewpoint of topology. This led to the idea behind string graphs.

Second, in a completely different field of *circuit-designing*, Sinden [Sin66] studied ‘printed’ circuits. The printed circuits were strictly planar, where crossovers were made by letting one of the conductors out of the plane. But integrated RC circuits (made by depositing thin metallic and dielectric films in suitable patterns on an insulating substrate) allowed crossovers between some pair of conductors to be possible in the board itself. The problem of finding out which circuits are realizable led to the study of string graphs.

1.3.1 Subclasses of interest

Now we discuss some subclasses of string graphs. Our first subclass is geometrical in nature. An L-shape is union of a *vertical segment* and a *horizontal segment* such that the bottom end of the vertical segment is joined to the left end of the horizontal segment. The intersection of the two segments is called the *corner point* of the L. Given a line l a representation is called *grounded* if every object in the representation has a specific point on the grounding line l , and all the geometric objects lie in the same halfplane defined by l . A *grounded-L graph* is an intersection graph of L’s that have their topmost points on the horizontal grounding line.

Rest of the subclasses are topological in nature. The *rank* of a string graph is the smallest integer r such that the vertices of the graph can be represented

by strings that pairwise intersect at most r times. In this part of the thesis, we concentrate on the following three natural subclasses of string graphs. When two strings intersect at most once, the resulting intersection graphs are known as *1-string graphs*. They are precisely string graphs of rank 1.

When the strings are contained in a disk with one endpoint on its boundary, the resulting intersection graphs are known as *outerstring graphs* [Kra91a]. We use the following alternate definition: An outerstring graph is the intersection graph of curves that are contained in a halfplane with one endpoint of each string in the boundary of the halfplane (the grounding line; hence outerstring graphs are the same as *grounded string graphs*). To see how these two definitions are equivalent, one can define a homeomorphism from a closed half-plane to a closed disk minus one boundary point. See Cardinal et al. [CFM⁺18] for a proof. When two strings in an outerstring representation intersect at most once, the resulting intersection graphs are known as *outer 1-string graphs*.

In case of the grounded graphs (grounded-L, outer 1-string or outerstring graphs), we consider the grounded line to be vertical and the geometric objects lie in the left halfplane with only their rightmost end on the grounding line. This is equivalent to any other convention (vertical or horizontal orientation of the grounding line and the halfplane the geometric objects would lie in). We denote the class of grounded-L graphs by GROUNDED-L, the class of 1-string graphs by 1-STRING, the class of outerstring graphs by OUTERSTRING, and the class of outer 1-string graphs by OUTER 1-STRING.

Next, we talk about containment relations (an important line of questioning in this thesis: see Chapter 4) among these subclasses of string graphs. The following proper containment relations holds for the discussed subclasses of string graphs:

$$\text{GROUNDED-L} \subset \text{OUTER 1-STRING} \subset \text{OUTERSTRING}, \text{1-STRING} \subset \text{STRING}.$$

An separating example for the proper containment $\text{OUTERSTRING} \subset \text{STRING}$ is the full subdivision of the complete graph on four vertices. Otherwise, we can extend the outerstring representation of the full subdivision of K_4 to get a string representation of the full subdivision of K_5 : a contradic-

tion. (The full subdivision of K_4 being planar is a string graph, in fact, 1-string graph.) This also implies OUTER 1-STRING \subset 1-STRING. Dangelmayr, Felsner, and Trotter [DFT10] (also see [Dan10]) gave the following separating example for the proper containment 1-STRING \subset STRING. Consider the split graph K_n^3 with vertex partition $V_C \cup V_I$ such that $V_C = [n]$ induces a clique, and $V_I = \binom{[n]}{3}$ induces an independent set such that each vertex $(x, y, z) \in V_I$ is adjacent to exactly three vertices $x, y, z \in V_C$. Dangelmayr, Felsner, and Trotter [DFT10] proved that K_n^3 is not a 1-string graph. But since it is chordal, it has a string representation. Jelínek and Töpfer [JT19] extended the results of Cardinal et al. [CFM⁺18] and proved the first two proper containment relations, that is, GROUNDED-L \subset OUTER 1-STRING \subset OUTERSTRING.

As mentioned earlier, using extremal graph theory and hereditary properties of graphs, Pach and Tóth [PT06] proved that there are $2^{\binom{3}{4}+o(1)}\binom{n}{2}$ string graphs on n vertices. Using the same techniques, we can show that there are at most $2^{\binom{2}{3}+o(1)}\binom{n}{2}$ outerstring graphs on n vertices. Similar results are given by Jansen and Uzzell [JU17] using graph limits. Kyncl [Kyn13] proved that there are at most $2^{O(n^{3/2} \log n)}$ 1-string graphs on n vertices. Results of similar nature were obtained Sauermann [Sau21] using tools from algebraic geometry and differential topology.

In the rest of this section, we deal with a coloring problem of 1-string graphs of girth five. As a first step in this direction, we solve a generalized version of this problem for grounded-L, outer 1-string and outerstring graphs.

1.3.2 Coloring 1-string graphs

Many interesting problems on the *vertex chromatic number* (denoted χ) of intersection graphs of geometric objects have been studied. One such class of problems explores its dependence on *girth* [Age99, AG60, EO09, KN98, Mc00b, PKK⁺14] (also see [Neš13]). The main purpose of this work is to attack a problem by Kostochka and Nešetřil [KN98] on coloring *1-string graphs* with girth five.

Borrowing notation from Kostochka and Nešetřil [KN98], given a class of intersection graphs \mathcal{G} , let

$$\chi_g(\mathcal{G}, k) := \max_{G \in \mathcal{G}} \{\chi(G) \mid \text{girth}(G) \geq k\}.$$

One of the popular problems in this regard was posed by Erdős (see [Gyá87, Problem 1.9]) in the 1970s⁷. His question can be translated to the following: Is $\chi_g(\text{SEGMENT}, 4) < \infty$ (Problem 1 in [KN98]), where SEGMENT is the class of intersection graphs of line segments in the plane. Further, Kratochvíl and Nešetřil asked a similar problem (see [KN95]): Is $\chi_g(1\text{-STRING}, 4) < \infty$? (Problem 2 in [KN98].)

However, recently these questions were resolved in the negative by Pawlick et al. [PKK⁺14]. They proved that $\chi_g(\text{SEGMENT}, 4)$ can be arbitrarily large, by constructing triangle-free segment intersection graphs with arbitrarily high chromatic number.

Earlier, in 1998, motivated by the above problems, Kostochka and Nešetřil [KN98] studied 1-string graphs with girth at least five. In particular, they proved that $\chi_g(1\text{-STRING}, 5) \leq 6$. This is surprising as then it was not known whether the chromatic number of segment graphs and 1-string graphs with girth four are bounded or not. And the proof is elegant. They also posed if $\chi_g(1\text{-STRING}, 5) > 3$. Hence, the best known bounds are $3 \leq \chi_g(1\text{-STRING}, 5) \leq 6$.

Our main objective is to improve the bounds of $\chi_g(1\text{-STRING}, 5)$. To this end, our first step is to find $\chi_g(\text{OUTER } 1\text{-STRING}, 5)$. As mentioned earlier, a popular way of studying geometric intersection graphs with girth 5 is via degeneracy. We show that outer 1-string graphs of girth at least five are 2-degenerate. Studying degeneracy in outer 1-string graphs is a natural approach in improving the upper bound of $\chi_g(1\text{-STRING}, 5)$ due to the following reason. Given a 1-string representation (with girth $g \geq 5$), we can treat its *outer envelope* as the boundary of the disk containing the outer 1-string representation. The graph induced by the other strings intersecting this *boundary* is an outer 1-string graph. As we shall see, the target string (corresponding to the vertex with degree at most two) in an outer 1-string representation is in some sense *closest* to the boundary. This would result in finding a degree three vertex in the 1-string graph (because of the girth restriction) and hence proving them to be 4-colorable. There are some hidden details. We shall address this in a future work.

⁷An approximate date was confirmed in a personal communication with András Gyárfás and Janós Pach to the authors of [PKK⁺14]. See footnote 2 in Pawlick et al. [PKK⁺14].

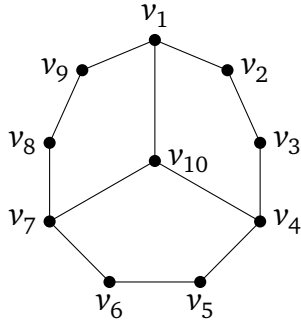

Figure 1.4: Separating Example G' .

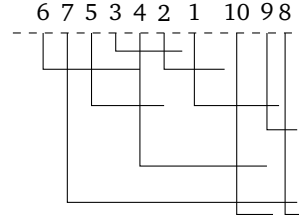

Figure 1.5: Grounded-L representation of G' .

Finding $\chi_g(1\text{-STRING}, 5)$ via degeneracy arguments also generalizes a result of Ageev [Age99], who proved that circle graphs (intersection graphs of chords of a circle) with girth at least five are 2-degenerate. In fact, we prove a stronger result that generalizes the corresponding result on circle graphs by Esperet and Ochem [EO09]. They proved that circle graphs with girth $g \geq 5$ and minimum degree $\delta \geq 2$ have a chain of $(g - 4)$ degree 2 vertices. (See Figure 1.4 and Figure 1.5.)

Following the main theme of this thesis, we first study the corresponding problems on grounded-L graphs with girth at least five. We then extend some of the ideas to prove the results for outer 1-string graphs with girth at least five, and then further to outerstring graphs with girth at least five. This also improves the latest bound of five by Gavenčiak et al. [GGJ⁺18] on $\chi_g(\text{OUTERSTRING}, 5)$ which they proved via the *Cops and robber* game.

The result on grounded-L graphs also addresses a simple problem arising from the result of McGuinness [Mc96] that implies $\chi_g(\text{GROUNDED-L}, k) \leq 2^{14}$, for $k \geq 4$. Using some simple geometric arguments⁸ we prove that $\chi_g(\text{GROUNDED-L}, 5) = 3$, stated as a corollary of the result stating the 2-degeneracy result. The equality follows as odd cycles belong to GROUNDED-L (and hence to OUTER 1-STRING and OUTERSTRING). We now state the results for GROUNDED-L, OUTER 1-STRING and OUTERSTRING.

Grounded-L

Theorem 3. *Grounded-L graphs with girth five are 2-degenerate.*

⁸In contrast, rest of the proofs go via a not so simple inductive framework and use topological arguments.

Corollary 1. $\chi_g(\text{GROUNDED-L}, 5) = 3$

Theorem 4. *Grounded-L graphs with girth $g \geq 5$ and minimum degree $\delta \geq 2$ contains a chain of $(g - 4)$ vertices of degree two.*

Outer 1-string

Theorem 5. *Outer 1-string graphs with girth five are 2-degenerate.*

Corollary 2. $\chi_g(\text{OUTER 1-STRING}, 5) = 3$.

Theorem 6. *Outer 1-string graphs with girth $g \geq 5$ and minimum degree $\delta \geq 2$ contains a chain of $(g - 4)$ vertices of degree two.*

Outerstring

Theorem 7. *Outerstring graphs with girth five are 2-degenerate.*

Corollary 3. $\chi_g(\text{OUTERSTRING}, 5) = 3$.

Theorem 8. *Outerstring graphs with girth $g \geq 5$ and minimum degree $\delta \geq 2$ contains a chain of $(g - 4)$ vertices of degree two.*

It suffices to prove [Theorem 4](#), [Theorem 6](#) and [Theorem 8](#) — the main result for each graph class — which we do in [Chapter 3](#).

1.4 Bend Graphs

In this section, we continue our study of string representations approximated by rectilinear curves. Consider a string graph and its string representation. We can embed the strings in a fine enough grid such that rectilinear curves replace the strings while inducing an isomorphic arrangement. Informally, we call it as a *bend representation*. Thus, every string graph has such a bend representation.

One of the theoretical motivations of studying such bend representations of string graphs is to introduce the *bend number* of a string graph. The bend number of a graph is the minimum number k such that there exists a bend

representation of the graph where each of the rectilinear curves have at most k *bends*, that is, number of right angle turns in the paths.

Here is the catch. Our notion of bend representation and, consequently, the bend number completely depends on the definition of *intersection*. To be more precise, on what do we *mean by two rectilinear curves intersecting*. There are two main notions of intersections, and both of them were defined by Golumbic and others.

The first notion was introduced by Golumbic, Lipshteyn and Stern [GLS09], in 2009, called as the *edge intersection representations of paths on a grid*. Here, two rectilinear curves *intersect* if they share an edge on the grid. That is, they both have a continuous part in common: just a crossing intersection does not count. The graphs that have such a representation are known as *edge intersection graph of paths on a grid*, in short *EPG graphs*.

The second notion was introduced by Asinowski et al. [ACG⁺12], in 2012, called as the *vertex intersection representations of paths on a grid*. Here, two rectilinear curves *intersect* if they share a point in common. The graphs that have such a representation are known as *vertex intersection graph of paths on a grid*, in short *VPG graphs*.

Motivations Golumbic and others [GLS09, ACG⁺12] introduced the EPG and VPG graphs citing two practical motivations from circuit design and chip manufacturing.

First, we go back to a similar motivation of studying string graphs in the field of circuit design. Recall that, traditionally, printed circuits were strictly planar, where crossovers were made by letting one of the conductors out of the plane. But integrated RC circuits (made by depositing thin metallic and dielectric films in suitable patterns on an insulating substrate) allowed crossovers between some pair of conductors to be possible in the board itself. The problem of finding out which circuits are realizable (appropriate crossovers can be made) led to the study of string graphs. Later, these circuits were modelled in square grids (see the survey by Molitor [Mol91]).

In the knock-knee layout model [BS90], the objective is to place wires on a grid such that two wires can cross or bend at a grid point but no two paths share an edge, that is, wires cannot overlap. In a legal layout (spanning mul-

multiple layers), the intersection graph induced in each layer is an independent set of vertices. Golumbic, Lipshteyn and Stern [GLS09] adopted this model to study EPG graphs. The minimum coloring problem of EPG graphs will result in the knock-knee layout with the minimum number of layers.

Sometimes two paths are not allowed to intersect. Asinowski et al. [ACG⁺12] used this model to study VPG graphs. The minimum coloring problem of VPG graphs will result in the knock-knee layout with the minimum number of layers.

Another motivation comes from chip manufacturing. Whenever a wire bends in a chip layout, it requires a transition hole. Thus, a large number of bends result in a large number of holes, which in turn results in a larger chip area. This directly increases the chip cost. Hence the need for minimizing the total number of bends. A lot of research has been done in these kinds of layout optimization problems. Golumbic and others initiated the study of EPG and VPG graphs to capture these problems with an additional constraint of minimizing bends per wire, as it directly motivates the notion of bend number.

1.4.1 EPG Graphs

All graphs are EPG graphs. This feels a bit strange: how to represent a non-string graph as an EPG representation. The property of just crossing intersections does not contribute to an edge is used to tackle this. We refer to Golumbic, Lipshteyn, and Stern [GLS09] for details, as our focus is on VPG graphs. Next, we briefly survey some results on EPG graphs, mainly to highlight the lines of research pursued. Let B_k -EPG denote the class of EPG graphs with bend number at most k ; B_k^m -EPG denote the class of EPG graphs with bend number at most k whose EPG representation consists of only monotonic increasing curves (both in terms of X and Y-coordinates).

Golumbic, Lipshteyn, and Stern [GLS09] introduced EPG graphs in 2009. This paper introduced a few challenging lines of query.

First, they begin with some examples of EPG graphs; surprisingly, they show that every graph is an EPG graph. Many other graph classes are known to have a small bend number: (1) trees are in B_1 -EPG (Golumbic, Lipshteyn, and Stern [GLS09]); (2) outerplanar graphs are in B_2 -EPG (Heldt, Knauer, and Ueckerdt [HKU14b]); (3) planar graphs are in B_4 -EPG [HKU14b]; (4)

graphs with tree-width k are in B_{2k-2} -EPG [HKU14a]; (5) Halin graphs are in B_2 -EPG (Francis and Lahiri [FL16]); and (6) circular-arc graphs⁹ are in B_3 -EPG (Alcón et al. [ABD⁺15]).

Second is on computational complexity. Golumbic, Lipshteyn, and Stern [GLS09] posed the question of finding the complexity of recognizing B_k -EPG graphs, for all $k \geq 1$. Following up on this question, Heldt, Knauer, and Ueckerdt [HKU14a] proved that recognizing B_1 -EPG graphs is NP-hard. Later, Pergel and Rzażewski [PR17] proved that it is NP-complete to decide if a graph is in B_2 -EPG. On other graph problems, Epstein, Golumbic, and Morgenstern [EGM13] proved that COLORING and INDEPENDENT SET is NP-complete for B_1 -EPG.

Third, Golumbic, Lipshteyn, and Stern [GLS09] introduced some combinatorial problems related to EPG graphs. They showed that every graph of order n and size m has an EPG representation on $n \times (n + \frac{m}{2})$ grid. Biedl et al. [BDD⁺18] proved that a graph of size m requires $\Omega(m)$ area. On other combinatorial results, Asinowski and Suk [AS09] showed that there are $2^{O(km \log(kn))}$ labeled graphs that are in B_k -EPG.

Finally, they also introduced strict containment relations between related graphs. They proved that there exists graphs that are not in B_1 -EPG. They showed that B_0 -EPG $\subsetneq B_1$ -EPG $\subsetneq B_2$ -EPG; and B_1^m -EPG $\subsetneq B_1$ -EPG. They posed the question of extending these relations. Following up on the question on B_k -EPG, Asinowski and Suk [AS09] proved that B_k -EPG $\subsetneq B_{k+1}$ -EPG, for odd k . Heldt, Knauer, and Ueckerdt [HKU14a] showed that the bend number of $K_{m,m}$ is $\lceil m/2 \rceil$, and hence B_k -EPG $\subsetneq B_{k+1}$ -EPG. Following up on the question on B_k^m -EPG, Çela and Gaar [CG20] proved that B_k^m -EPG $\subsetneq B_k$ -EPG, for $k = 2, 3, 4, 5, 7, 8, \dots$; B_k -EPG $\not\subsetneq B_{2k-9}^m$ -EPG; and B_1 -EPG $\subsetneq B_3^m$ -EPG.

Another line of research that has naturally come up is regarding the characterizations of EPG graphs and their subclasses. Ries [Rie09] proved that if a graph (of order n) is in B_1 -EPG, then it contains a clique or an independent set of size $n^{1/3}$. Thus, the Erdős-hajnal conjecture holds for B_1 -EPG graphs. Asinowski and Ries [AR12] later improved this bound to $n^{1/4}$. There are many minimal forbidden induced subgraph characterizations: (1) for B_1 -EPG graphs by Cohen, Golumbic, and Ries [CGR14], (2) for split B_1 -EPG

⁹Circular-arc graphs are intersection graphs of arcs on a circle.

graphs by Deniz et al. [DNR⁺18]; (3) for proper circular-arc B_1 -EPG graphs by Galby, Mozzoleni, and Ries [GMR19]; and (4) for maximal outerplanar B_1 -EPG graphs by Çela and Gaar [CG20].

Our focus is to study strict containment relations for VPG graphs.

1.4.2 VPG Graphs

The first result of Asinowski et al. [ACG⁺12] was to prove the equivalence of VPG graphs and string graphs (please see Chapter 4 for details). One can then partition the string graphs into equivalence classes based on their bend number. Traditionally, VPG graphs with bend number at most k is denoted by B_k -VPG, but as from now onwards, we deal with VPG graphs only (and not EPG graphs) we represent them by \mathcal{B}_k for simplicity. Next, we survey results on VPG graphs, following the same theme of survey for EPG graphs. Define $\text{GRAPH CLASS-}\mathcal{B}_k = \text{GRAPH CLASS} \cap \mathcal{B}_k$.

Asinowski et al. [ACG⁺12] introduced VPG graphs in 2009. They introduced a few challenging lines of query.

First, they gave some examples of graph classes that are VPG graphs. They showed that VPG graphs are equivalent to the string graphs, grid intersection graphs¹⁰ are equivalent to graphs in $\text{BIPARTITE-}\mathcal{B}_0$, and circle graphs are equivalent to graphs in \mathcal{B}_1 . Chaplick et al. [CJK⁺12] proved that $\mathcal{B}_k \not\subseteq \text{SEGMENT}$. Chaplick and Ueckerdt [CU13] showed that planar graphs are in \mathcal{B}_2 and the construction can be made in $O(n^{3/2})$ time. They also showed that 4-connected planar graphs are intersection graphs of rectilinear- Z shapes, and bipartite graphs are in 2-DIR (equivalent to grid intersection graphs). Biedl and Derka [BD16] improved this by proving that that planar graphs are in 1-string \mathcal{B}_2 and 4-connected planar graphs are intersection graphs of rectilinear C and Z shapes, including their horizontal mirror images. Finally, Gonçalves, Iselmann, and Pennarun [GIP18] showed that planar graphs are in \mathcal{B}_1 . In fact, they showed a stronger result that that planar graphs are L-graphs, and used it to give a simple proof that planar graphs belong to SEGMENT .

Second is on computational complexity and algorithms. Asinowski et al. [ACG⁺12] proved that recognition of \mathcal{B}_0 and coloring graphs in \mathcal{B}_0 are

¹⁰Grid intersection graphs are the intersection graphs of horizontal and vertical line segments in the plane.

NP-complete. They gave a 2-approximation algorithm for coloring \mathcal{B}_0 and proved that Δ -free graphs in \mathcal{B}_0 are 4-colorable. Chaplick et al. [CJK⁺12] proved that recognizing \mathcal{B}_k is NP-complete even if a \mathcal{B}_{k+1} representation is given. Golubic and Ries [GR13] gave a linear-time algorithm for recognizing SPLIT- \mathcal{B}_0 . Lahiri, Mukherjee, and Subhramanian [LMS15] gave two approximation algorithms for INDEPENDENT SET for \mathcal{B}_1 , one of them with time-complexity $O((\log n)^2)$. Mehrabi [Meh18] gave a $O(1)$ approximation algorithm for DOMINATING SET on \mathcal{B}_1 . Chakraborty, Das, and Mukherjee [CDM19] proved that DOMINATING SET is NP-hard for UNIT- \mathcal{B}_k and gave a $O(k^4)$ approximation algorithm for the same (also see [Cha20]).

Third, Asinowski et al. [ACG⁺12] introduced some combinatorial problems related to VPG graphs. They proved that graphs in \mathcal{B}_0 have strong helly number 2. Cohen et al. [CGT⁺16] proved that for a cocomparability graph G , $b(G) \leq \dim(\overline{G}) - 1$ and this bound is tight. Biedl and Derka [BD17] showed that curves of bend representation of graphs in \mathcal{B}_2 can be partitioned into $O(\log n)$ groups that represent outerstring graphs or $O((\log n)^3)$ groups that represent permutation graphs.

Finally, we look at strict containment relations between graph classes: the main topic of our queries on bend graphs. Asinowski et al. [ACG⁺12] proved that $\mathcal{B}_0 \subsetneq \mathcal{B}_1 \subsetneq VPG$. Chaplick et al. [CJK⁺12] proved that $\mathcal{B}_k \subsetneq \mathcal{B}_{k+1}$, for all $k \in \mathbb{N}$.

Another line of research that has naturally come up is regarding the characterizations of VPG graphs and their subclasses. Golubic and Ries [GR13] gave a minimal forbidden induced subgraph characterization of SPLIT- \mathcal{B}_0 . Cohen, Golubic, and Ries [CGR14] proved that a cograph is in \mathcal{B}_0 if and only if it is W_4 -free. Cohen, Golubic, Trotter, and Wang [CGT⁺16] proved that a cograph is in \mathcal{B}_0 if and only if it is W_4 -free. Alc3n, Bonomo, and Mazzoleni [ABM17] gave a minimal forbidden induced subgraph characterization of BLOCK- \mathcal{B}_0 .

Problems and Results

Coming back to our graph classes, the following containment relations are obvious from the definition of \mathcal{B}_k .

$$\mathcal{B}_0 \subseteq \mathcal{B}_1 \subseteq \dots \subseteq \mathcal{B}_k \subseteq \mathcal{B}_{k+1} \dots$$

Asinowski et al. [ACG⁺12] proved strict containment of \mathcal{B}_0 in \mathcal{B}_1 , that is, $\mathcal{B}_0 \subsetneq \mathcal{B}_1$. They conjectured that this strict containment continues for all k , that is, $\mathcal{B}_k \subsetneq \mathcal{B}_{k+1}$ for all $k \geq 0$. These questions are not straightforward to address in case of geometric intersection graphs (see Cabello and Jejčič [CJ17] for similar questions).

Chaplick et al. [CJK⁺12] proved the conjecture of Asinowski et al. [ACG⁺12]. However, their constructed examples were not chordal. Hence they posed the following open problem.

Open question 1. *Is $\text{CHORDAL-}\mathcal{B}_k \subsetneq \text{CHORDAL-}\mathcal{B}_{k+1}$, for all $k \geq 0$?*

Addressing the above open question is the main purpose of this section. In fact, other questions that are addressed in this section have their roots in Open Question 1. We address Open Question 1 by proving the following result. Note that $\text{SPLIT} \subset \text{CHORDAL}$.

Theorem 9. *There exists infinitely many values of k such that $\text{SPLIT-}\mathcal{B}_k \subsetneq \text{SPLIT-}\mathcal{B}_{k+1}$.*

In order to prove Theorem 9, we first prove that for all $k \in \mathbb{N}$, there exists a split graph G of order $n + \binom{n}{k}$, whose bend number is strictly greater than $k/2 - 8$. Then we give a bend representation of G with bend number $f(k) = 2\binom{n-1}{k-1} - 1$. Thus G is a separating example between $\text{SPLIT-}\mathcal{B}_{k/2-8}$ and $\text{SPLIT-}\mathcal{B}_{f(k)}$; and hence a separating example between $\text{SPLIT-}\mathcal{B}_t$ and $\text{SPLIT-}\mathcal{B}_{t+1}$, for some $k/2 - 8 \leq t < f(k)$.

Although Theorem 9 is a first step in addressing Open Question 1, we note that $f(k)$ is exponential in k , that is, there is an exponential gap between the upper and lower bounds. Can we do any better if we relax the graph class a bit? This is addressed in our next result.

The question asked by Chaplick et al. [CJK⁺12] concerns chordal separating examples between \mathcal{B}_k and \mathcal{B}_{k+1} . Chordal graphs are precisely the graphs

that are free of induced cycles of length at least four, that is, $\text{CHORDAL} \equiv \text{FORB}(C_{\geq 4})$. If we apply our techniques used to prove [Theorem 9](#) to the string graphs in $\text{FORB}(C_{\geq 5})$ (that is, we allow induced 4-cycles in our graphs), then we can restrict $f(k)$ to be linear in k . This is our next result.

Theorem 10. *For all $t \in \mathbb{N}$, $\text{FORB}(C_{\geq 5})\text{-}\mathcal{B}_t \subsetneq \text{FORB}(C_{\geq 5})\text{-}\mathcal{B}_{4t+29}$.*

The above questions relating to the graph class \mathcal{B}_k are addressed in [Chapter 4](#). Next we address similar questions on the graph class $\text{PROPER-}\mathcal{B}_k$.

The problems addressed till now had no restriction on the number of intersection points between two paths. What if one does not allow any overlapping intersection, that is, there are finite number of intersection points between any two paths. Chaplick et al. [[CJK⁺12](#)] considered this and defined a proper bend representation as one where (1) the paths are simple, (2) there are finite intersection points, and (3) each intersection point belongs to exactly two paths at which they cross. This is captured by our earlier definition, where we also defined proper bend number and the graph classes $\text{PROPER-}\mathcal{B}_k$. The following containment relations are obvious from the definition of $\text{PROPER-}\mathcal{B}_k$.

$$\text{PROPER-}\mathcal{B}_0 \subseteq \text{PROPER-}\mathcal{B}_1 \subseteq \cdots \subseteq \text{PROPER-}\mathcal{B}_k \subseteq \text{PROPER-}\mathcal{B}_{k+1} \cdots$$

We continue our study of strict containment relations (and separating examples) for these graph classes defined based on the proper bend number. Although, the above results hold for $\text{PROPER-}\mathcal{B}_k$ as the proper bend number of a string graph is at least its bend number, and the upper bound constructions are all proper bend representations¹¹, we can do much better. Using completely different techniques, we prove the following.

Theorem 11. *For all $t \in \mathbb{N}$, $\text{SPLIT-PROPER-}\mathcal{B}_t \subsetneq \text{SPLIT-PROPER-}\mathcal{B}_{36t+80}$.*

As in the previous cases, this involves a lower bounding argument and an upper bound construction. These are presented in [Chapter 4](#).

¹¹The upper bound construction in [Theorem 9](#) (see [Theorem 15](#)) can be modified to obtain a proper bend representation with the same number of bends per path

Part: INTERPLAY

In the last two parts, we studied arrangement graphs and intersection graphs on curves. This part is on a concluding note where we look into the connection between arrangements of finite curves and string graphs. Arrangements of finite curves are more general than the pseudoline arrangements we studied in the first part of this chapter. By definition of string graphs, these arrangements of finite curves are equivalent to the string representations. This natural connection is the object of study of this part. We have already mentioned this connection in [subsection 1.1.3](#).

1.5 The Coloring Question of Kostochka and Nešetřil

We revisit the problem of Kostochka and Nešetřil [[KN98](#)] that exploits this connection between arrangements of pseudosegments and 1-string graphs. This problem was the focus of [Section 1.3](#) in the part on intersection graphs. They studied the maximum chromatic number of 1-string graphs with girth at least five and proved the following.

Theorem 12. [*Kostochka and Nešetřil* [[KN98](#)]]

$$\chi_g(1\text{-STRING}, k) = \begin{cases} 6, & k \geq 5; \\ 4, & k \geq 6; \\ 3, & k \geq 8. \end{cases}$$

The highlight of the proof of [Theorem 12](#) is its elegance. The proof mainly relies on the connection we are talking about by finding the number of faces in the arrangement realization of the 1-string graph in terms of the number of vertices and edges of the 1-string graph. They complete the proof by using some properties of color-critical graphs and Euler's formula.

We present their proof except a small change in the second part. We came across this initially using the observations obtained during proving the degree

sequence-based characterization of pseudoline arrangement graphs ([Theorem 1](#)). This furthermore highlights the natural connection between arrangements of finite curves and 1-string graphs. However, it turns out that the route via the degree observations can be completely replaced via a simple observation. Nevertheless, we hope these observations to be helpful elsewhere.

In the rest of the thesis, we summarize our results.

1.6 Organization of the Thesis

The rest of the thesis is divided into four chapters. They are composed of three parts: two parts addressing the two graph classes that arise from geometric representations of curves, and one part addressing the connection between them. Next, we summarize the details covered in each chapter.

Arrangement Graphs of Curves

Chapter 2: *Pseudoline Arrangement Graphs* — In this chapter, we first study the *Pseudoline Arrangement Graph Realization Problem* (in [Theorem 1](#)) i.e. given a sequence of finite numbers, whether there is a pseudoline arrangement graph that realizes it. If the answer to this problem is yes, we construct a (pseudo)line arrangement realization. Next, we study the graph-theoretic analog of the classic computational geometry problems of finding the envelope and the Euclidean diameter of line arrangement graph realizations in [Theorem 2](#) and [Proposition 1](#), respectively.

Intersection Graphs of Curves

Chapter 3: *String Graphs* — In this chapter, we begin the study of intersection graphs of curves, namely string graphs. Our focus is to study a coloring problem of Kostochka and Nešetřil on 1-string graphs with girth five on the following subclasses of string graphs: *grounded-L graphs*, *outer 1-string graphs*, and *outerstring graphs*.

Given a class of intersection graphs \mathcal{G} , we find the maximum of the chromatic number of a graph in \mathcal{G} with girth at least five. We prove a stronger structural result for *grounded-L graphs*, *outer 1-string graphs*, and *outerstring graphs* in [Theorem 4](#), [Theorem 6](#), and [Theorem 8](#), respectively. These

results generalize theorems of Ageev, and Esperet and Ochem on circle graphs of girth at least five. For grounded-L graphs, our result addresses a theorem of McGuinness. For outerstring graphs, our result improves the previous bounds of Gavenčiak et al. on the maximum chromatic number of outerstring graphs with girth five.

Chapter 4: Bend Graphs — In this chapter, we continue the study of string graphs (intersection graphs of finite curves) but as bend graphs: intersection graphs of rectilinear curves, a geometric variant of string graphs. This correspondence allows us to parametrize the class of string graphs with the *bend number*. One can then form classes of string graphs \mathcal{B}_k whose bend number is at most k . Answering a question of Asinowski et al., Chaplick et al. proved that $\mathcal{B}_k \subsetneq \mathcal{B}_{k+1}$. They further asked whether the separating example can be made chordal. In response, we prove [Theorem 9](#) where we show that there are infinitely many values such that there are separating examples that are split graphs (which are also chordal). This result follows from an interesting lower bounding technique and upper bound construction. In another direction, in [Theorem 10](#), we observe that once we allow cycles of length four, then the bend number of the upper bound construction is drastically reduced. Next, in [Theorem 11](#), we study similar strict containment relations concerning *proper bend numbers*.

Interplay Between the Two Graph Classes

Chapter 5: Interplay — We end the thesis by highlighting the natural connection between arrangement graphs and string graphs obtained from the same arrangement of finite curves. This connection is explored via the coloring problem of Kostochka and Nešetřil [[KN98](#)] on 1-string graphs with girth five that was the focus of [Chapter 3](#). We present their proof, except a small change that was initiated by using the techniques developed in the proof of the degree sequence based characterization of pseudoline arrangement graphs ([Theorem 1](#)) in [Chapter 2](#).

1.7 Final Remarks

Papers related to the thesis

- **ARRANGEMENT GRAPHS:** The degree sequence based characterization was presented at the *International Conference on Algorithms and Discrete Applied Mathematics CALDAM 2021* [DRS21] where we had also announced the results on eccentricities. The journal version is under review.
- **OUTERSTRING GRAPHS:** The results on outerstring graphs was presented at the *European Workshop on Computational Geometry EuroCG 2021* [DMS21b] and the results on outer 1-string will shortly be presented in the *European Conference on Combinatorics, Graph Theory and Applications EUROCOMB 2021* [DMS21a]. The journal version is under preparation.
- **BEND GRAPHS:** The results on proper containment of \mathcal{B}_k -VPG graphs is published in the journal *Theory of Computing Systems ToCS* [CDM⁺19].

2 Pseudoline Arrangement Graphs

Contents

2.1	Introduction	45
2.2	Our Results	48
2.2.1	The Pseudoline Arrangement Graph Realization Problem	48
2.2.2	Eccentricities in Pseudoline Arrangement Graphs	50
2.3	Tools Used	52
2.3.1	Definitions and Notations	52
2.4	Pseudoline Arrangement Graph Realization Problem	53
2.4.1	Proof of Necessity of Theorem 1	54
2.4.2	Construction and Operations	55
2.4.3	Proof of Sufficiency of Theorem 1	57
2.5	Eccentricities in Pseudoline Arrangement Graphs	59
2.5.1	Basic Results	59
2.5.2	Diameter and Characterization of Vertices with Maximum Eccentricity	63
2.6	Final Remarks	67
2.6.1	Following our Theme	67
2.6.2	Open Problems	67
2.6.3	Alternate Proof of $d_2 \geq 3$ in Theorem 1 using Wiring Diagrams	68
2.6.4	A Brief Review on Degree Sequence-based Characterizations	69
2.6.5	Acknowledgements	70

2.1 Introduction

First, we recall the definition of a pseudoline arrangement graph.

The class of *pseudoline arrangement graphs* $\mathcal{G}_{\mathcal{L}}$ are graphs induced by simple arrangements $\mathcal{A}(L)$, for any set of pseudolines L , whose vertices are intersection points of pseudolines in L , and there is an edge between two vertices if they appear on one of the pseudolines, say $l \in L$, with no other

vertices in the part of l between the two vertices. The realization of a pseudoline arrangement graph G_L by pseudolines in L is its *pseudoline arrangement realization* $R(G_L)$. We get a pseudoline arrangement realization from its corresponding pseudoline arrangement by deleting the two infinite segments of each pseudoline. We have analogous definitions by replacing pseudolines with lines.

As mentioned in [Section 1.2](#), realizations of both the graphs are unique up to isomorphism. Bose, Everett, and Wismath [[BEW03](#)] considered a line arrangement realization and joined all vertices of degree less than four to a vertex v_∞ in the unbounded face. Then they showed this extended graph to be 3-connected (using biconnectedness of the line arrangement graph). Since the extended graph is also planar, a result of Whitney [[Whi32](#)] implies the existence of its unique embedding in the plane with v_∞ on the exterior face. They show that removing v_∞ and the edges incident to it results in the unique realization of a line arrangement graph, up to isomorphism. Eppstein [[Epp14](#)] extended this argument, adding a few more details, to show the uniqueness of pseudoline arrangement realization (up to isomorphism).

Pseudoline arrangement graphs strictly contain line arrangements graphs. The separating example is built corresponding to the separating example for pseudoline arrangements and line arrangements. Levi [[Lev26](#)] gave a separating example for non-simple arrangements on nine pseudolines. He used the *Pappus hexagon theorem* [[Wei21](#)] to prove the non-stretchability of the separating example. However, we need a separating example that is simple. Ringel [[Rin56](#)] showed how to convert the non-simple non-Pappus arrangement into a separating example for simple pseudoline arrangements on nine pseudolines. Grunbaum [[Grü72](#)] conjectured it to be the smallest separating example, which was confirmed by Goodman and Pollack [[GP84](#)] (also see [[FG17](#)]). The pseudoline arrangement graph corresponding to this arrangement does not have a line arrangement realization.

Hence, pseudoline arrangements generalize line arrangements. As pseudolines behave like lines, except the straightness aspect, pseudoline arrangements preserve the basic topological and combinatorial properties of line arrangements. And the same is inherited by their corresponding graph classes. Since the problems discussed in this chapter are of graph-theoretic nature, as

expected, they hold for both the graph classes — they do not depend on the *straightness* of the lines. As a result, we focus on the general class: pseudoline arrangement graphs, highlighting only the differences.

In contrast, the computational complexities differ for their corresponding recognition problems. Bose, Everett, and Wismath [BEW03] proved that recognizing line arrangement graphs is NP-hard by reduction from *simple stretchability*. It follows from Schaefer [Sch09] that *simple stretchability* is $\exists\mathbb{R}$ -hard. Hence the reduction of Bose, Everett, and Wismath [BEW03] also implies that recognizing line arrangement graphs is $\exists\mathbb{R}$ -hard (see [Epp14, p. 212]). On the other hand, Eppstein [Epp14] proved that pseudoline arrangement graphs can be recognized in linear time. At its core, his recognition algorithm builds upon the ideas of Bose, Everett, and Wismath [BEW03].

Applications of (pseudo)line arrangement graphs

- ***k*-set problem:** Eppstein [Epp14] gave a linear-time algorithm to draw a (pseudo) line arrangement graph in a grid of area $O(n^{7/6})$. He also proved that any pseudoline arrangement graph causing the algorithm to use $\Omega(n^{1+\epsilon})$ area would imply significant progress in the *k-set problem* (see [Mat02, Chap. 11]) in combinatorial geometry. This connection between the *k*-set problem and the combinatorial complexity of *k*-level in the arrangement is via duality.
- **Computational Complexities of Other Geometric Parameters:** The $\exists\mathbb{R}$ -hardness of recognizing line arrangement graphs (due to the NP-hardness reduction of Bose, Everett, and Wismath [BEW03] and the $\exists\mathbb{R}$ -hardness result of Schaefer [Sch09]) leads to the following results in finding computational complexity of some other geometric parameters. This result/reduction is used
 1. by Durocher et al. [DMN⁺13] to prove that checking whether there is a straight-line drawing of a planar graph with at most *k* segments is NP-hard (in fact, it is $\exists\mathbb{R}$ -hard),
 2. by Chaplick et al. [CFL⁺17] to prove that the *line cover number* of a planar graph in two dimensions and a graph in three dimensions are $\exists\mathbb{R}$ -hard to compute, and

3. by Okamoto, Ravsky, and Wolff [ORW19] to prove that many variants of the *segment number* of a planar graph are $\exists\mathbb{R}$ -hard to compute.

Organization: In [Section 2.2](#), we state our result ([Theorem 1](#)) on the Pseudoline Arrangement Graph Realization Problem ([subsection 2.2.1](#)), followed by our results ([Section 2.5](#) and others) on eccentricities of vertices in pseudoline arrangement graphs ([subsection 2.2.2](#)). This is followed by details of the standard tools used for studying pseudoline arrangements in [Section 2.3](#). Then, we prove [Theorem 1](#) in [Section 2.4](#) and [Theorem 2](#), amongst other results, in [Section 2.5](#). We end with some open questions and discussions in [Section 2.6](#).

2.2 Our Results

2.2.1 The Pseudoline Arrangement Graph Realization Problem

We revisit the problem and our result.

Pseudoline Arrangement Graph Realization Problem. Given a sequence of finite numbers π , whether there is a pseudoline arrangement graph with degree sequence π .

The following restated theorem solves the Pseudoline Arrangement Graph Realization Problem. The proof is given in [Section 2.4](#). For an affirmative answer, we also construct a (pseudo) line arrangement realization.

Theorem 1. *A finite non-increasing sequence of positive numbers π is a degree sequence of a (line arrangement graph) pseudoline arrangement graph if and only if it satisfies the following two conditions.*

1. $\pi = \langle 4^{d_4}, 3^{d_3}, 2^{d_2} \rangle$ with $3 \leq d_2 \leq n$, $d_3 = 2(n - d_2)$ and $d_4 = n(n - 5)/2 + d_2$ for some integer $n \geq 3$.
2. If $d_2 = n$, then n is odd.

Other graph classes have stronger characterizations based on the degree sequences. A graph class \mathcal{G} has a *degree sequence characterization* if one can recognize whether a graph $G \in \mathcal{G}$ or not, based on its degree sequence. Hence

to recognize whether $G \in \mathcal{G}$ or not, one needs to check if the degree sequence of G satisfies all the conditions of the degree sequence characterization. This often leads to linear-time recognition algorithms [BDK⁺08, HS81, Mer03]. (We present a brief review in [subsection 2.6.4](#).) However, for the following reason, we cannot infer anything about the recognition of pseudoline arrangement graphs from [Theorem 1](#).

A 2-switch operation replaces a pair of edges xy and zw in a simple graph by the edges yz and wx , given that yz and wx were not edges in the graph. Performing a 2-switch operation in a graph does not change its degree sequence. The class of pseudoline arrangement graphs $\mathcal{G}_{\mathcal{L}}$ is not *closed* under the 2-switch operation, that is, after performing a 2-switch operation in $G_L \in \mathcal{G}_{\mathcal{L}}$, the resulting graph may not be in $\mathcal{G}_{\mathcal{L}}$ (easy to check on the arrangement graph induced on four pseudolines). This kills all the hope for obtaining a degree sequence characterization for pseudoline arrangement graphs. Thus, in this “sense”, [Theorem 1](#) is the best one can hope for. This is also strongly indicated by the following: [Theorem 1](#) also holds for line arrangement graphs (see [Remark 3](#)), which are $\exists\mathbb{R}$ -hard (and hence NP-hard) to recognize (see [BEW03, Sch09]).

We further want to highlight that [Theorem 1](#) also implies that the class of pseudoline arrangement graphs cannot have a *forbidden graph characterization*, that is, a characterization for recognizing a graph class by specifying a list of graphs that are forbidden to exist as (or precisely, be isomorphic to) an induced subgraph of any graph in the class. A result of Greenwell et al. [GHK73] says that a graph class has a forbidden graph characterization if and only if it is closed under taking induced subgraphs. The pseudoline arrangement graphs are not closed under vertex deletions. Indeed, [Theorem 1](#) implies that deleting any vertex in a pseudoline arrangement graph does not result in a pseudoline arrangement graph. Hence pseudoline arrangement graphs cannot have a forbidden graph characterization.

The graph realization problem is just a preliminary query in the more general framework of degree-based graph construction problem in *network modeling* [KTE⁺09]. Given a sequence π , let \mathcal{N} be the set of realizations of π (up to isomorphism) that satisfy some conditions. A degree sequence-based graph construction problem asks (i) if $\mathcal{N} \neq \emptyset$, (ii) if it is possible to construct

a member of \mathcal{N} , (iii) to find (asymptotics of) $|\mathcal{N}|$, (iv) if there is a way to construct all (or a fixed fraction) of graphs in \mathcal{N} , and other questions. We have addressed the first two questions for (pseudo) line arrangement graphs. We leave the other two questions as open problems. The separating examples of line arrangement graphs and pseudoline arrangement graphs imply that the answers to (iii) and perhaps (iv) are going to be different for the two graph classes.

2.2.2 Eccentricities in Pseudoline Arrangement Graphs

In this part, we focus on finding the diameter and radius of pseudoline arrangement graphs. Our results turn out to be graph-theoretic analogues of the following two classic computational geometry problems. The first is due to Ching and Lee [CL85] whose focus was on finding the Euclidean diameter of a line arrangement. They also studied the second problem — the envelope of a line arrangement. Later, Eu, Grévremont and Toussaint [EGT96] gave an efficient algorithm for finding the envelope of a line arrangement.

We begin with the following result on diameter of pseudoline arrangement graphs.

Proposition 1. *The diameter of a pseudoline arrangement graph on n pseudolines is $n - 2$.*

Surprisingly, the diameter of a pseudoline arrangement graph is independent of the graph and depends only on the number of pseudolines in its realization.

As a prelude to [Proposition 1](#), we begin with some basic observations regarding the properties of shortest paths and eccentric vertices in [subsection 2.5.1](#). They vary from the restrictions on the shortest paths between two vertices to the existence of particular types of eccentric vertices. These observations are also of independent interest. Using these observations, or otherwise, we prove [Proposition 1](#) in [subsubsection 2.5.2](#).

Our next aim is to find the radius of pseudoline arrangement graphs. Unlike the diameter, one can see that the radius of a pseudoline arrangement graph will depend on the graph structure. Our central idea is to prove that as we move to the interior of the pseudoline arrangement realization, after

iteratively removing the outer layer of vertices, one would expect the eccentricity of vertices in the inner layers to decrease. As a first step, we begin by characterizing diametrical vertices in the pseudoline arrangement graphs, that is vertices whose eccentricity equals to the graph diameter. We prove it in [subsubsection 2.5.2](#).

Theorem 2. *A vertex v in a pseudoline arrangement graph G is a diametrical vertex if and only if v lies in the outer face of its realization $R(G)$.*

Observe that [Theorem 2](#) fixes the vertices that occur in the outer face of the realization of a (pseudo) line arrangement graph. In other words, it characterizes the intersection points of (pseudo) line arrangements that lie in the *envelope* of the arrangement. As mentioned earlier, coincidentally, finding the envelope of a line arrangement is a subproblem pursued by Ching and Lee [[CL85](#)] while finding the Euclidean diameter of line arrangements.

However, we are still to prove any non-trivial bounds on the radius. We hope [Theorem 2](#) to be a starting point for such a result. We suspect the pseudoline arrangement graph got by the *star construction* (defined later) to have the maximum radius. We leave this as an open problem. Another open problem is to characterize the central vertices in a pseudoline arrangement graph, that is, vertices whose eccentricity equals the graph radius.

Future works on generalization. We can pose similar questions on the generalized non-simple (pseudo) line arrangements. In particular, the question of the graph realization problem and diameter are interesting for general (pseudo) line arrangements. For the graph realization problem of general line arrangements, a natural hurdle in fixing the necessary conditions seems to be the Dirac-Motzkin conjecture [[Dir51](#)] on *ordinary lines* (for all n). However, the graph realization problem of general pseudoline arrangements does not have this issue.

The diameter of general (pseudo) line arrangement graphs will depend on the graph structure (unlike their simple counterparts). Hence finding tight lower bounds on the diameter for these (non-trivial) cases seems interesting. We keep these lines of questioning for future work.

2.3 Tools Used

We need the following common notions and constructions for pseudoline arrangements. See the book by Felsner [Fel04, Chap. 6] for definitions and detailed constructions. Here we give a succinct description. For a fixed unbounded region f of a pseudoline arrangement \mathcal{A} on n pseudolines, there is always an unbounded region f^* that is *separated* from f by all pseudolines. Note that the boundaries of f and f^* have two pseudolines in common. Fix points $x \in f$ and $x^* \in f^*$. We *topologically sweep* the arrangement to form an aesthetic arrangement of polylines (pseudolines made up of line segments) called the *wiring diagram* [Goo80] corresponding to the sweep. This process uses *allowable sequences* [GP84], which we do not describe here.

Consider the internally disjoint oriented x^*, x -curves that do not contain any vertex of the arrangement and that crosses each pseudoline once. A *topological sweep* of the arrangement is a sequence c_0, \dots, c_r of such oriented x^*, x -curves with $r = \binom{n}{2}$ such that there is one vertex between the curves c_i and c_{i+1} . Here c_0 is the oriented x^*, x -curve such that all the vertices in \mathcal{A} lie to the right of c_0 (with respect to the orientation of c_0). Label the pseudolines from 1 to n such that c_0 intersects the pseudolines in increasing order. Next, we form the wiring diagram corresponding to this topological sweep.

Fix n horizontal wires. We confine the pseudolines to these wires, except for the parts where they cross each other. Corresponding to the topological sweep, we have a sequence p_0, \dots, p_r of vertical lines with p_i to the left of p_j , for $i < j$. The ordering of polylines in which p_0 intersects from bottom to top is $1, 2, \dots, n$. Between p_i and p_{i+1} , we allow only the two pseudolines that form the vertex between c_i and c_{i+1} to intersect. Hence the ordering of the polylines that intersects p_i from bottom to top is the same as the ordering of pseudolines that intersects c_i from x^* to x . We call this the *wiring diagram* corresponding to the topological sweep. See [Figure 2.1](#) for an illustration.

2.3.1 Definitions and Notations

Since we are dealing with pseudolines, which are topological analogs of lines, we shall come across terms like *pseudohalfplane*, *pseudoquadrant*, *pseudotriangle*, *pseudopolygon* etc., in our arguments; the prefix *pseudo* denotes the topological analog of the following term.

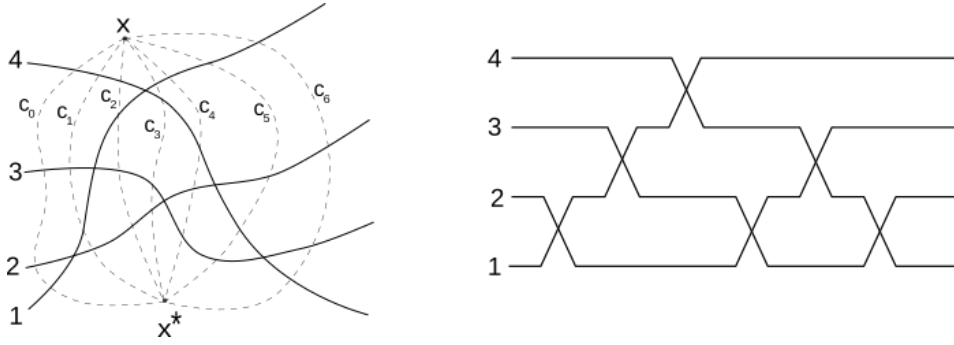

Figure 2.1: Topological sweep of a pseudoline arrangement and its wiring diagram.

Let G_L be a pseudoline arrangement graph with realization $R(G_L)$. The *span* of each pseudoline is the part of the pseudoline drawn in $R(G_L)$, that is, the part of the pseudoline between its end vertices. A *path* P is a sequence of distinct vertices, such that consecutive vertices are adjacent. The *length* of a path P , denoted $|P|$, is the number of edges in P . The length of the shortest u, v -path is $d(u, v)$. For vertices u and v in the path P in G_L , let $uv|_P$ denote the u, v -path in P , with length $d(u, v)_P$. For vertices u and v in line $l \in L$, let $uv|_l$ denote the u, v -path in l , with length $d(u, v)_l$. For points c and d (may not be in $V(G_L)$) that are on different pseudolines, let \overline{cd} denote the line segment between c and d . If a vertex $u \in V(G_L)$ is an intersection point of two pseudolines l_1 and l_2 , then we say $u = l_1 \cap l_2$. For vertices $u, v \in V(G_L)$ not lying on a pseudoline l , we say l *separates* u and v if they lie on different pseudohalfplanes bounded by l .

We give the relevant definitions specific to the proofs in their respective sections. Now we are ready to prove our results.

2.4 Pseudoline Arrangement Graph Realization Problem

Now we solve the pseudoline arrangement graph realization problem, that is, we prove [Theorem 1](#). For convenience, we restate [Theorem 1](#).

Theorem 1. *A finite non-increasing sequence of positive numbers π is a degree sequence of a (line arrangement graph) pseudoline arrangement graph if and only if it satisfies the following two conditions.*

1. $\pi = \langle 4^{d_4}, 3^{d_3}, 2^{d_2} \rangle$ with $3 \leq d_2 \leq n$, $d_3 = 2(n - d_2)$ and $d_4 = n(n - 5)/2 + d_2$ for some integer $n \geq 3$.
2. If $d_2 = n$, then n is odd.

For proof of necessity, we need to show that the degree sequence of a graph in our class satisfies the conditions of the theorem. For this purpose, the proof for pseudolines also holds for lines.

However, for the proof of sufficiency, we need to show that if a sequence satisfies the given conditions then we can construct such a graph with the given degree sequence. Since every line arrangement graph is a pseudoline arrangement graph and not vice-versa, we shall construct a line arrangement graph. Thus, for proof of necessity we prove for pseudolines and for proof of sufficiency we prove for lines.

2.4.1 Proof of Necessity of Theorem 1

Suppose the degree sequence π has a pseudoline arrangement realization on $n \geq 3$ pseudolines. Since every pair of pseudolines intersect, $d_2 + d_3 + d_4 = n(n - 1)/2$. Each of the end vertices of every pseudoline is either a 2-vertex or a 3-vertex: each 2-vertex is an end vertex of two pseudolines, and each 3-vertex is an end vertex of one pseudoline. Thus $2d_2 + d_3 = 2n$. From both these equations, $d_3 = 2(n - d_2)$, $d_4 = n(n - 5)/2 + d_2$ and $d_2 \leq n$.

We claim $d_2 \geq 3$. To see this, we first extend the realization to an arrangement on n pseudolines. Next, extend the arrangement to a pseudoline arrangement on $n + 1$ pseudolines in the real projective plane by adding an imaginary pseudoline l at infinity. A standard result by Levi [Lev26] (also see [Fel04, Prop. 5.13]) shows that every such pseudoline is incident to at least three triangles. In particular, l is incident to at least three triangles in this arrangement in the real projective plane. Each of these triangles corresponds to unbounded regions with two pseudolines in its boundary in the arrangement in the Euclidean plane. The intersection point of these two pseudolines corresponds to a 2-vertex in the realization. Hence $d_2 \geq 3$.

If $d_2 = n$ then $d_3 = 0$, that is, each of the end vertex of every pseudoline is a 2-vertex. In such an arrangement consider any pseudoline l . Let u and

v be the end vertices of l . Pseudoline l divides the plane into two open pseudohalfplanes, denoted l^+ and l^- . The other two pseudolines from u and v meet in one of the pseudohalfplanes, say (without loss of generality) l^+ . Let the number of 2-vertices in l^+ be k . Thus the number of 2-vertices in l^- is $n - k - 2$. All other pseudolines, except the three incident at u or v , cross the part of l between u and v . We double count such crossings: for all the 2-vertices in l^- there are $2(n - k - 2)$ such crossings, and for all the 2-vertices in l^+ there are $2k - 2$ crossings. Thus $2k - 2 = 2(n - k - 2)$. This implies $n = 2k + 1$. Hence if $d_2 = n$ then n is odd. This completes the necessity part of the proof.

Remark 1. One can also derive the first condition of [Theorem 1](#) from the argument involving the [projective plane](#) in proving $d_2 \geq 3$. However, we want to highlight the approach using the two equations, as they hold for graphs induced by a more general arrangement of simple finite curves, which can be used to prove a result of Kostochka and Nešetřil [[KN98](#)]. Details are given in [Chapter 5](#). An alternate proof of $d_2 \geq 3$ using *wiring diagrams* is given in [subsection 2.6.3](#).

Remark 2. Most of the first condition is intuitive and can also be concluded from the observations of Bose, Everett, and Wismath [[BEW03](#)] and Durocher et al. [[DMN⁺13](#)]. This shows the importance of the second condition in [Theorem 1](#) for capturing the pathological case and completing the characterization.

To prove the sufficiency of [Theorem 1](#), we construct a line arrangement realization having the given degree sequence. First, we need the following construction and operations.

2.4.2 Construction and Operations

Star construction

For odd n , place n vertices uniformly on a circle and join each vertex to its opposite two farthest vertices. This results in a line arrangement realization on n lines called a *star construction on n vertices*. The center of the circle is called the *center of the star construction*. The rest of the vertices are 4-vertices that lie within the circle. The star construction on n vertices has degree sequence $\langle 4^{n(n-3)/2}, 2^n \rangle$.

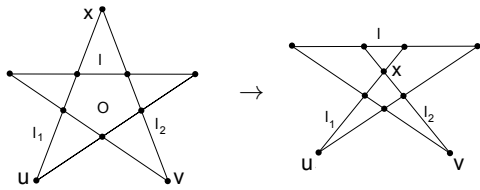

Figure 2.2: Pull Operation

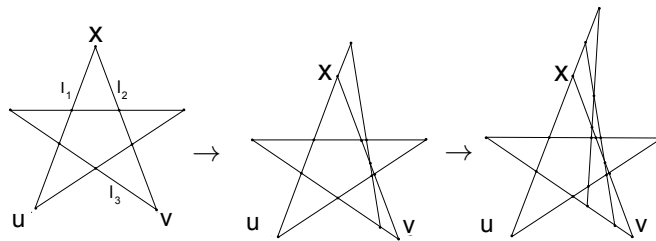

Figure 2.3: Two line operations on the 2-vertex x

Pull Operation

Consider a 2-vertex x in a star construction on at least 5 vertices with O as the center of the star construction. Let $x = l_1 \cap l_2$ with the other end vertices of l_1 and l_2 as u and v , respectively. Let l be the first line crossed while moving from x to O along the line segment \overline{xO} . Rotate l_1 and l_2 about u and v such that $x = l_1 \cap l_2$ comes closer to O till x crosses l , while keeping the slope of \overline{xO} fixed (see [Figure 2.2](#)). Now x becomes a 4-vertex and two new 3-vertices are created at the expense of two 4-vertices in the star construction. In this operation, the number of 2-vertices decreases by one. Hence the degree sequence changes from

$$\langle 4^{d_4}, 2^{d_2} \rangle \text{ to } \langle 4^{d_4-1}, 3^2, 2^{d_2-1} \rangle.$$

Line Operation

In the target degree sequence, if d_2 is odd, then consider a star construction. Choose a 2-vertex $x = l_1 \cap l_2$ with the other end vertices of l_1 and l_2 as u and v respectively, which are also 2-vertices. Let l_3 be the other line intersecting l_2 at v . Take a point on the line l_1 that is close to x and just outside the span of l_1 in the realization. Also, take a point in the realization on the line l_3 and close to v . Joining these two points, we add a new line l to the realization that intersects all the span of other lines except the span of l_1 in the realization of the star construction (as shown in [Figure 2.3](#)). In the new realization, $l_1 \cap l$ forms a new 2-vertex, making x a 3-vertex. Thus the number of 2-vertices is unaffected. The other end vertex of l is also a 3-vertex, increasing the number of 3-vertices by 2. The rest of the new vertices introduced are 4-vertices.

By doing k line operations on x , we add k such new lines to the realization close to x . On constructing such new lines we make sure that their intersec-

tion points with l_3 (and with l_1), in order of their addition, form a monotonic sequence of points in l_3 (and in l_1). It ensures that the new line added also intersects the previously added lines before reaching its end vertex, which is a 3-vertex (refer [Figure 2.3](#)). Upon performing k line operations on a star construction on d_2 vertices, the number of 2-vertices remains unchanged; the number of 3-vertices increases by $2k$; and the number of 4-vertices increases by

$$\binom{d_2 + k}{2} - \binom{d_2}{2} - 2k = k \left(d_2 + \frac{k-5}{2} \right).$$

Hence the degree sequence changes from

$$\langle 4^{d_4}, 2^{d_2} \rangle \text{ to } \langle 4^{d_4 + k(d_2 + \frac{k-5}{2})}, 3^{2k}, 2^{d_2} \rangle.$$

In the target sequence, if d_2 is even, then we first consider a star construction on $d_2 + 1$ with one pull operation on it. This realization has d_2 2-vertices. We can also perform line operations on this realization. Repeating the above calculations, upon performing k line operations on a star construction on $d_2 + 1$ vertices with a pull operation, the number of 2-vertices remains unchanged; the number of 3-vertices increases by $2k$; and the number of 4-vertices increases by

$$\binom{d_2 + 1 + k}{2} - \binom{d_2 + 1}{2} - 2k = k \left(d_2 + \frac{k-3}{2} \right).$$

Hence the degree sequence changes from

$$\langle 4^{d_4}, 3^2, 2^{d_2} \rangle \text{ to } \langle 4^{d_4 + k(d_2 + \frac{k-3}{2})}, 3^{2+2k}, 2^{d_2} \rangle.$$

Now we are ready to prove the sufficiency part of the [Theorem 1](#).

2.4.3 Proof of Sufficiency of Theorem 1

Let π be a degree sequence satisfying the properties given in [Theorem 1](#) for some value of n . We give an algorithm to draw a line arrangement realization with degree sequence π .

Algorithm

For odd d_2 , do a star construction on d_2 vertices. If $d_2 = n$, then n is odd, and we have the required line arrangement realization; else do $n - d_2$ line operations on a 2-vertex of the star to get the required realization. For even d_2 , do a star construction on $d_2 + 1$ vertices and then do a pull operation on one of the 2-vertices, resulting in d_2 2-vertices. If $d_2 = n - 1$, then we have the required line arrangement realization; else if $n > d_2 + 1$, then do $n - d_2 - 1$ line operations on a 2-vertex of the star construction to get the required realization. This results in a line arrangement realization with degree sequence π .

Correctness

For odd d_2 , a star construction on d_2 vertices results in the degree sequence

$$\pi_s = \langle 4^{d_2(d_2-3)/2}, 2^{d_2} \rangle.$$

If $d_2 = n$, then $\pi_s = \pi$. If $d_2 < n$, then performing $n - d_2$ line operations increases d_4 by

$$(n - d_2) \left(d_2 + \frac{n - d_2 - 5}{2} \right) = \frac{n^2}{2} - \frac{d_2^2}{2} - \frac{5n}{2} + \frac{5d_2}{2};$$

increases d_3 by $2(n - d_2)$; and d_2 remains same. This results in the degree sequence

$$\langle 4^{n(n-5)/2+d_2}, 3^{2(n-d_2)}, 2^{d_2} \rangle.$$

For even d_2 , a pull operation on a star construction on $d_2 + 1 \geq 5$ vertices results in degree sequence

$$\pi_{sp} = \langle 4^{(d_2+1)(d_2-2)/2-1}, 3^2, 2^{d_2} \rangle.$$

If $d_2 = n - 1$, then

$$\pi = \langle 4^{n(n-3)/2-1}, 3^2, 2^{n-1} \rangle = \langle 4^{n(n-5)/2}, 3^2, 2^{n-1} \rangle,$$

that is, $\pi_{sp} = \pi$. If $d_2 < n - 1$, then performing $n - d_2 - 1$ line operations

increases d_4 by

$$(n - d_2 - 1) \left(d_2 + \frac{n - d_2 - 4}{2} \right) = \frac{n^2}{2} - \frac{d_2^2}{2} - \frac{5n}{2} + \frac{3d_2}{2} + 2;$$

increases d_3 by $2(n - d_2 - 1)$; and d_2 remains same. This results in the degree sequence

$$\langle 4^{n(n-5)/2+d_2}, 3^{2(n-d_2)}, 2^{d_2} \rangle.$$

Thus, the algorithm gives a realization with degree sequence π . This completes the proof of the sufficiency of [Theorem 1](#), and hence the complete proof of [Theorem 1](#). \square

Remark 3. The construction in the proof of the sufficiency of [Theorem 1](#) is a line arrangement realization. Furthermore, the proof of necessity also goes through for line arrangements. Hence, [Theorem 1](#) also solves the line arrangement graph realization problem.

2.5 Eccentricities in Pseudoline Arrangement Graphs

2.5.1 Basic Results

To find the eccentricity of a vertex, we shall find one of its eccentric vertices. For this purpose, we derive some basic results on the shortest paths and eccentric vertices in pseudoline arrangement graphs, which are of independent interest. First, we need the following definitions.

Consider two vertices u and v in a pseudoline arrangement that do not lie on the same pseudoline. Let $u = l_1 \cap l_2$ and $v = l_3 \cap l_4$. For each vertex in the pseudoline arrangement, the two intersecting pseudolines divide the Euclidean plane into four pseudoquadrants. Let Q_v denote the pseudoquadrant defined by l_1 and l_2 that contains vertex v . Similarly, let Q_u denote the pseudoquadrant defined by l_3 and l_4 that contains vertex u . Let $Q_{uv} = Q_u \cap Q_v$.

The following simple observation can be proved by strong induction.

Proposition 2. *For vertices u and v on pseudoline l , the shortest u, v -path completely lies on l , and this path is unique.*

Proof. We proceed by strong induction on $d(a, b)_l$. For the base case, when $d(a, b)_l = 1$, vertices a and b are adjacent on l . So $P = ab|_l$ is the unique shortest a, b -path. As our induction hypothesis, we assume that for $d(a, b)_l < k$, $P = ab|_l$ is the unique shortest a, b -path.

Now let $d(a, b)_l = k$. Suppose there exists another shortest a, b -path P' ($\neq P$). We shall show that $d(a, b)|_P < d(a, b)|_{P'}$, thereby contradicting the existence of P' . [Proposition 2](#) is implied from the following observations.

Observation 1. *If $V(P) \cap V(P') \supsetneq \{a, b\}$, then $P' = P$.*

Proof of [Observation 1](#). Suppose $V(P) \cap V(P') \supsetneq \{a, b\}$; then there exists $c \in V(P) \cap V(P')$ with $c \notin \{a, b\}$. Let $P_1 = ac|_P$, $P_2 = cb|_P$, $P'_1 = ac|_{P'}$ and $P'_2 = cb|_{P'}$. Since $d(a, c)_l < k$, by our induction hypothesis, $ac|_l$ is the unique shortest a, c -path. Similarly, $cb|_l$ is the unique shortest c, b -path. Thus, $P_1 = P'_1$ and $P_2 = P'_2$; hence $P = P'$. ◀

So we are left with the case where $V(P) \cap V(P') = \{a, b\}$.

Observation 2. *If $V(P) \cap V(P') = \{a, b\}$, then $|P'| > |P|$.*

Proof of [Observation 2](#). Let $P = ab|_l = aa_1a_2 \dots a_{k-1}b$ and $P' = ab_1b_2 \dots b_s b$ such that $V(P) \cap V(P') = \{a, b\}$, then it suffices to prove that $s > k - 1$.

Consider the path P' . For $i \in [s]$, let l_i represent the pseudoline at b_i that does not contain the edge $b_{i-1}b_i$ for $i > 1$, or the edge ab_1 for $i = 1$.

First we claim that $l_i \neq l_j$, for $i \neq j$ and $i, j \in [s]$, that is, each pseudoline l_i is unique. Suppose for some b_t , with $t \leq s$, the pseudoline encountered, l_t , is not unique. Then there exists some b_r , with $r \neq t$, such that $l_r = l_t$. Our induction hypothesis implies that $b_r b_{r+1} \dots b_t$ (without loss of generality assume $r < t$) lies on l_t . In particular, $b_{t-1}b_t$ lies on l_t ; a contradiction (by definition of l_t). Hence at each b_i , we encounter an unique pseudoline l_i .

For each $j \in [k - 1]$, the line intersecting l at a_j is some l_i , for $i \in [s]$ (that contains vertex b_i in P'). This occurs as $P \cup P'$ is a closed curve with P being on a pseudoline, and hence no other pseudoline intersects P twice. Thus $s \geq k - 1$. For strict inequality observe that there exists a b_u with $u \leq s$, such that $l_u \cap l = \{b\}$. This l_u does not contain any a_j . Thus $s > k - 1$. ◀

[Observation 1](#) and [Observation 2](#) imply that P is our required unique shortest a, b -path. ◻

Next, we study the shortest paths between any two vertices in a pseudoline arrangement graph. The following is a consequence of [Proposition 2](#).

Proposition 3. *For any two vertices u and v , a shortest u, v -path of length k has vertices on $k + 2$ pseudolines.*

Proof. Let $P = uv_1v_2 \dots v_{k-1}v$ be a shortest u, v -path of length k . Traverse the path P from u to v and count the new pseudolines encountered. At vertex u we encounter two pseudolines. At each v_i , for $i \in [k - 1]$, and at v we encounter a new pseudoline, else by [Proposition 2](#), the minimality of length of P is contradicted. So we encounter $k + 2$ pseudolines in total. \square

Our next proposition is the analog of [Proposition 2](#), for vertices that do not lie on a pseudoline.

Proposition 4. *For vertices u and v not on the same pseudoline, the shortest path between them completely lies in Q_{uv} .*

Proof. First, we claim that any shortest u, v -path lies in Q_v . Let $u = l_1 \cap l_2$. For the sake of contradiction, let P be a shortest u, v -path that does not lie completely in Q_v , that is, at least one vertex in P lies *outside* Q_v . By outside, we mean not even in l_1 or l_2 . Thus there exists a vertex v_f in P that lies in l_1 or l_2 such that the vertex just before v_f in P lies outside Q_v . By [Proposition 2](#), there is a strictly shorter u, v -path than P . This contradicts the minimality of P .

Similarly, any shortest u, v -path lies in Q_u . Hence, the shortest u, v -path lies in Q_{uv} . \square

Our next result shows that one of the eccentric vertices of any vertex lies on the outer face.

Proposition 5. *For a vertex $u \in V(G_L)$, there exists an eccentric vertex of u that is a 2-vertex or 3-vertex.*

Proof. Let v be an eccentric vertex of u , and let $d(u, v) = d$. Suppose v is a 4-vertex such that $v = l_3 \cap l_4$. Then u cannot be on l_3 or l_4 , else one of the end vertices of l_3 or l_4 is farther from u than v ; a contradiction.

Pseudolines l_3 and l_4 divide the plane into four pseudoquadrants, which we denote as Q_u, Q_{uc}, Q'_u and Q'_{uc} taken in a clockwise sense, such that Q_u contains u (see [Figure 2.4](#)). Let x_{l_3} and x_{l_4} be the neighbors of vertex v on

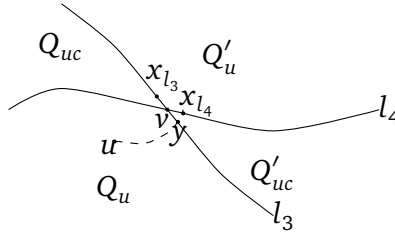

Figure 2.4: Illustration for [Proposition 5](#)

l_3 and l_4 , respectively, in Q'_u , that is, $x_{l_3} \in Q'_u \cap Q_{uc}$ and $x_{l_4} \in Q'_u \cap Q'_{uc}$. So l_3 separates vertices u and x_{l_4} , and l_4 separates vertices u and x_{l_3} .

We prove the following observations.

Observation 3. $d(u, x_{l_4}) = d$ and $d(u, x_{l_3}) = d$.

Proof of [Observation 3](#). We shall only prove the first equality; similarly, we can prove the second equality. Since $e(u) = d$, it follows that $d(u, x_{l_4}) \leq d$. If $d(u, x_{l_4}) < d$, then $d(u, x_{l_4}) = d - 1$. Indeed, else if $d(u, x_{l_4}) < d - 1$, then $d(u, v)_{\text{via } x_{l_4}} < d$; a contradiction.

Let P be a shortest u, x_{l_4} path. Choose vertex $y \in l_3 \cap P$ that is nearest to u , that is, $d(u, y)$ is minimum. The path P does not contain v , else $d(u, x_{l_4}) > d$; a contradiction.

[Proposition 2](#) implies that $d(y, v)_{l_3} < d(y, v)_{\text{via } x_{l_4}}$, that is, $d(y, v)_{l_3} \leq d(y, x_{l_4})$. This implies $d(u, v)_{\text{via } y} \leq d - 1$; and thus contradicts $d(u, v) = d$. Hence $d(u, x_{l_4}) = d$. ◀

Before proceeding further, we modify the pseudoline arrangement to an *isomorphic* one, where each pseudoline is a polyline with line segments between adjacent intersection points, and for every intersection point, each of the four angles between the two intersecting pseudolines (polylines)¹ is at most π . Such an arrangement can be obtained by considering the wiring diagram of the pseudoline arrangement and replacing the wires by line segments joining adjacent vertices. To see this, treat an intersection point in the wiring diagram as the origin of the co-ordinate axis system. Then each of its four quadrants has either an adjacent intersection point or the starting/ending point of one of the two pseudolines (if the origin is an end vertex).

¹One of the angles may be greater than π if the point of intersection of the two pseudolines (polylines) is a point of non-differentiability for both of them.

In such an arrangement we have the following observation. Let $\|p_1p_2\|$ denote the Euclidean distance between points p_1 and p_2 .

Observation 4. *At least one of $\|ux_{l_3}\|$ or $\|ux_{l_4}\|$ is greater than $\|uv\|$.*

Proof of Observation 4. If both $\|ux_{l_3}\| \leq \|uv\|$ and $\|ux_{l_4}\| \leq \|uv\|$, then $\angle x_{l_3}vx_{l_4} > \pi$. This contradicts our chosen arrangement. ◀

Observation 3 and Observation 4 imply the existence of a neighbor of v , say $x (= x_{l_3}$ or $x_{l_4})$, which is also an eccentric vertex of u such that $\|ux\| > \|uv\|$. If x is a 4-vertex, then we rename x as the new v and update the quadrants.

By repeating the above arguments, we get a sequence of distinct vertices $x = x_1, x_2, \dots$, such that $d(u, x_i) = d$ and $\|ux_i\| > \|ux_j\|$ for $i > j$. Since $|V(G_L)|$ is finite, the last vertex of the sequence is not a 4-vertex. Thus there exists an eccentric vertex of u that is a 2-vertex or 3-vertex. ◻

We immediately have the following corollary.

Corollary 4. *For a vertex $u \in V(G_L)$, there exists an eccentric vertex of u that lies in the outer face of $R(G_L)$.*

2.5.2 Diameter and Characterization of Vertices with Maximum Eccentricity

Diameter

Finding the diameter of a pseudoline arrangement graph is a straightforward implication of Proposition 3. However, one can also prove it without using Proposition 3. But first we restate the result.

Proposition 1. *The diameter of a pseudoline arrangement graph on n pseudolines is $n - 2$.*

Proof. For vertices u and v , Proposition 3 implies that $d(u, v) \leq n - 2$. The equality holds if u and v are the end vertices on a pseudoline. Hence diameter of a pseudoline arrangement graph realized on n pseudolines is $n - 2$. ◻

In the above context, Proposition 3 implies the following remark.

Remark 4. If $d(u, v) = n - 2 - i$, then every shortest uv -path has vertices on $n - i$ pseudolines. In particular, if $d(u, v) = n - 2$, then any shortest uv -path has vertices on all the n pseudolines.

Diametrical vertices

For vertices u and v , any shortest u, v -path has a vertex on every pseudoline that separates u and v . Therefore, the number of such separating pseudolines lower bounds $d(u, v)$.

Remark 5. For vertices u and v in a pseudoline arrangement graph,

$$d(u, v) \geq \begin{cases} \# \text{separating pseudolines} + 1, & \text{if } u \text{ and } v \text{ lie on the same} \\ & \text{pseudoline;} \\ \# \text{separating pseudolines} + 2, & \text{if } u \text{ and } v \text{ do not lie on the} \\ & \text{same pseudoline;} \end{cases}$$

Theorem 2 characterizes the diametrical vertices of a pseudoline arrangement graph, that is, vertices with eccentricity equal to the graph diameter.

Proof of **Theorem 2**

For the proof of sufficiency, if u is a vertex in the outermost layer of a pseudoline arrangement realization, then it belongs to one of the unbounded regions f in the arrangement. Let v be a vertex of the unbounded region f^* such that f^* is separated from f by every pseudoline. By **Remark 5** and **Proposition 1**, $d(u, v) = n - 2$. Hence u is a diametrical vertex.

For the proof of necessity, it suffices to show that if the vertex u does not lie in the outermost layer, then its eccentricity is strictly less than $n - 2$. Since u is not on the outermost layer, there is a triplet of pseudolines (l_1, l_2, l_3) such that u lies in the pseudotriangle T formed by them. Now consider any vertex v in the arrangement.

Depending on where v lies with respect to T , we have the following four cases: (1) v lies in the unbounded region of the induced arrangement on pseudolines l_1, l_2, l_3 , that has all three of them in its boundary; (2) v lies in the unbounded region of the induced arrangement on pseudolines l_1, l_2, l_3 , that has exactly two of them in its boundary; (3) v lies inside T ; and (4) v lies on the pseudolines l_1, l_2, l_3 . (Using **Proposition 5**, we can avoid case (3), however, it does not change the complexity of the proof.) We have to show that $d(u, v) < n - 2$.

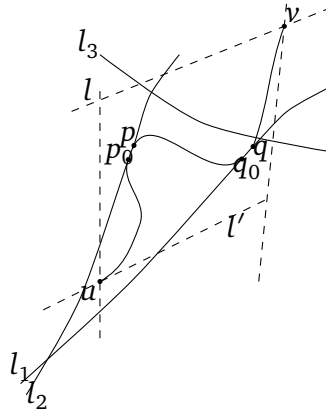

Figure 2.5: v lies in the unbounded 3-face

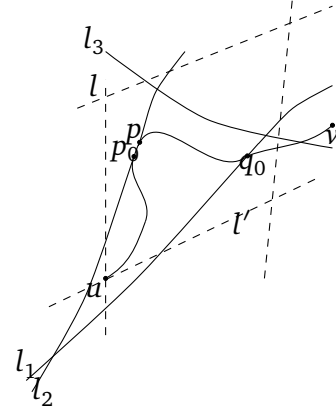

Figure 2.6: v lies in the unbounded 2-face

For the sake of contradiction, suppose $d(u, v) = n - 2$. From [Proposition 4](#), any shortest u, v -path is contained completely in the pseudo-4-gon Q_{uv} . Let P be such a shortest u, v -path. From [Proposition 3](#), for any pseudoline l , we have $l \cap Q_{uv} \neq \emptyset$ and l contains at least a vertex of P . This adds more restrictions on the possible configurations for path P . Two possible scenarios (for cases (1) and (2)) are depicted in [Figure 2.5](#) and [3.12c](#), respectively. Note that, in [Figure 2.5](#), $p_0 \neq p$ and $q_0 \neq q$, and in [Figure 3.12c](#), $p_0 \neq p$, else three pseudolines meet at a point. Moreover the nature of path $q_0 v|_P$ might vary, depending on the location of v (the four cases); but it does not affect our proof. In all possible scenarios that are not contradicted by [Proposition 2](#), the common structure is the path $uq_0|_P$ (see [Figure 2.7](#)). We have not highlighted the last two cases, where also, respecting [Proposition 4](#) and [Proposition 3](#), $uq_0|_P$ is the common structure. Thus it suffices to restrict our attention to this common path.

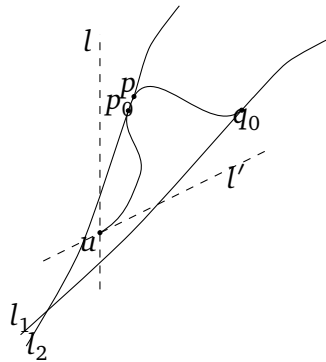

Figure 2.7: Common structure in all the cases.

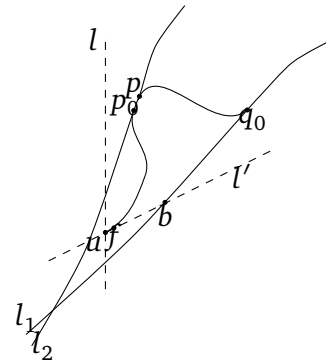

Figure 2.8: The closed polygon $f q_0|_{P_2} \cup f q_0|_{P_3}$

Next we compare between two u, q_0 -paths: the first path $P_1 = P|_{uq_0}$ and the second path P_2 lies on pseudolines l' and l_1 . Let $b = l' \cap l_1$. Choose the vertex $f \in P_1 \cap P_2$ to be the farthest vertex from u (that is, $d(u, f)$ is maximum) such that the u, f -path lies in $P_1 \cap P_2$ (see [Figure 2.8](#)). Note that f may be u .

Vertex f lies on l' . Indeed, if f lies on l_1 , then by [Proposition 2](#), P cannot be a shortest u, v -path; a contradiction. At this stage, we update the pseudolines l_1 and l_2 such that both $l \cap l_2$ and $l' \cap l_1$ are nearest to u , that is, $d(u, l \cap l_2)$ and $d(u, l' \cap l_1)$ is minimum. Thus none of the pseudolines intersect both $f b|_{l'}$ and $b q_0|_{l_1}$, else the choice of l_1 is contradicted.

Consider the closed pseudopolygon $f q_0|_{P_1} \cup f q_0|_{P_2}$, where $f q_0|_{P_2} = f b|_{l'} \cup b q_0|_{l_1}$. Let the vertices on $f q_0|_{P_2}$ be the following $f x_0 \dots x_s b x_{s+1} \dots x_t q_0$ such that $x_0 \dots x_s$ occur consecutively on l' and $x_{s+1} \dots x_t$ occur consecutively on l_1 . Consider vertices x_i , for $0 \leq i \leq t$, in an increasing order. For each x_i , with $0 \leq i \leq s$, let l_{x_i} denote the pseudoline such that $x_i = l_{x_i} \cap l'$; and for each x_i , with $s+1 \leq i \leq t$, let l_{x_i} denote the pseudoline such that $x_i = l_{x_i} \cap l_1$.

The pseudoline l_{x_i} also intersects $f q_0|_{P_1}$. Indeed, observe that $f q_0|_{P_1} \cup f q_0|_{P_2}$ is a closed pseudopolygon and there are no pseudolines that intersect both $f b|_{l'}$ and $b q_0|_{l_1}$ (because of our choice of l_1). And none of the pseudolines intersect $f b|_{l'}$ (respectively, $b q_0|_{l_1}$) twice as l' (respectively, l_1) is a pseudoline. Hence every line intersecting $f q_0|_{P_2}$ also intersects $f q_0|_{P_1}$.

Define the *corresponding vertex* of x_i in $f q_0|_{P_1}$ to be the vertex on $l_{x_i} \cap f q_0|_{P_1}$ that is closest to x_i . We claim that a vertex, say t , in $f q_0|_{P_1}$ can be the corresponding vertex of at most one x_i . Suppose a vertex t in $f q_0|_{P_1}$ is the corresponding vertex of both x_m and x_n . Then consider the vertex, say s , preceding t in $f q_0|_{P_1}$, that is, st is an edge in $f q_0|_{P_1}$. As t is the corresponding vertex of both x_m and x_n , s does not lie on l_{x_m} and l_{x_n} . Thus three pseudolines intersect at t , contradicting our assumption of a simple pseudoline arrangement.

Next, we have the following observation.

Observation 5. *Vertex p_0 is not a corresponding vertex of some x_i in $f q_0|_{P_2}$.*

Proof of [Observation 5](#). Suppose p_0 is a corresponding vertex of some x_k in $f q_0|_{P_2}$. Then the edge of $f q_0|_{P_1}$, other than $p_0 p$, that ends at p_0 cannot be on l_k , else by our definition the corresponding vertex of x_k comes before p_0 . It leads to a contradiction as three pseudolines intersect at p_0 . ◀

[Observation 5](#) implies that $d(u, q_0)|_{P_2} \leq d(u, q_0)|_{P_1}$. Thus $P_2 \cup q_0 v|_P$ is a

shortest u, v -path. But the pseudoline l_2 does not intersect it; so, by [Remark 4](#), $d(u, v) < n - 2$. This completes the proof of the necessity of [Theorem 2](#) and hence the proof of [Theorem 2](#). \square

As a direct consequence of [Theorem 2](#), we can also find the eccentricities of some vertices in the next layer. Let G_L be a pseudoline arrangement graph having vertices $V_{out} \subset V(G_L)$ on the outer face of its realization $R(G_L)$. The 1-layer of $R(G_L)$ is the outer face of the realization upon removing all vertices in V_{out} and their incident edges.

[Theorem 2](#) implies that any interior vertex has eccentricity less than $n - 2$. Notice that it is possible for vertices in the 1-layer of $R(G_L)$ to have no neighbors on the outer face. However, for vertices in the 1-layer which have a neighbor on the outer face, we have the following corollary.

Corollary 5. *Let u_1 be a vertex in the 1-layer of $R(G_L)$. If u_1 has a neighbor u in the outer face of $R(G_L)$, then $e(u_1) = n - 3$.*

Proof. Let v be an eccentric vertex of u , that is, $d(u, v) = n - 2$. If $e(u_1) < n - 3$, then $d(u_1, v) < n - 3$. This implies that $d(u, v) \leq d(u, u_1) + d(u_1, v) < n - 2$; a contradiction. So $d(u_1, v) = n - 3$. Since u_1 is an internal vertex, we have $e(u_1) = n - 3$. \square

2.6 Final Remarks

2.6.1 Following our Theme

All the results given in this chapter were proved for line arrangements first. Using geometry made things easier, for example, in proof of necessity of [Theorem 1](#), compare the use of Levi's result [[Lev26](#)] that every such pseudoline is incident to at least three triangles to a more simpler geometric argument. Also compare the use of wiring diagrams to standard geometric arguments. Following our theme, the geometric arguments were extended to topological ones, with a few necessary modifications.

2.6.2 Open Problems

Degree Sequence. In a general framework of questions involving degree sequences, a few more questions can be asked. Find (asymptotics of) the

number of (pseudo) line arrangement graphs, that satisfy the conditions of [Theorem 1](#)? As mentioned earlier, the separating examples for line arrangement graphs and pseudoline arrangement graphs imply that the answers are going to be different for the two graph classes. Moreover, can we construct some proportion of such graphs. This would add to the techniques presented in the proof of sufficiency of [Theorem 1](#).

The Question of Radius. As mentioned earlier, the major purpose of proving [Theorem 2](#) was to find bounds on the radius of pseudoline arrangement graphs. The diameter of a pseudoline arrangement graph does not depend on the graph but the number of pseudolines in its realization. But one can easily see that it would not be the case of the radius. A line arrangement graph with a centrally symmetric realization on n lines will have a smaller radius than a line arrangement graph with a skewed realization on n lines. For odd n , we suspect it to follow:

$$\left\lceil \frac{n}{2} \right\rceil - 1 \leq r(G) \leq \left\lfloor \frac{3(n-1)}{4} \right\rfloor.$$

The upper bound comes from the star construction. Another open problem is to characterize the central vertices in a pseudoline arrangement graph, that is, vertices whose eccentricity equals the graph radius.

2.6.3 Alternate Proof of $d_2 \geq 3$ in [Theorem 1](#) using Wiring Diagrams

Observe that the leftmost and rightmost intersection point in the wiring diagram of a pseudoline arrangement is always a 2-vertex; so $d_2 \geq 2$. Next, we consider a ‘restricted wiring diagram’ in which there is just one intersection point between the top two levels. In this case, observe that such an intersection point is also a 2-vertex. This 2-vertex differs from the leftmost and the rightmost intersection point in the wiring diagram (else one of the pseudolines has just one intersection point in it; a contradiction). Thus for a pseudoline arrangement with a wiring diagram that has only one intersection point between the top two levels, $d_2 \geq 3$. We claim that all pseudoline arrangements have such a restricted wiring diagram. To show this, we need to carefully set up the topological sweep that fixes the wiring diagram. Choose

the sweep line to originate from an unbounded face that is bounded by two pseudolines in the pseudoline arrangement (this always exists as $d_2 \geq 2$). Perform the topological sweep to form the required restricted wiring diagram.

2.6.4 A Brief Review on Degree Sequence-based Characterizations

For a given property P , invariant under isomorphism, a degree sequence is said to be (1) *potentially P -graphic* if at least one of its realizations satisfies property P and (2) *forcibly P -graphic* if all its realizations satisfy property P . Barrus, Kumbhat, and Hartke [BKH08] characterized the graph classes \mathcal{F} such that potentially \mathcal{F} -free sequences are also forcibly \mathcal{F} -free. In this survey, we focus on the recognition of graph classes based on their degree sequences, hence omitting those characterizations that explore the relationship between degree sequences and various graph properties. These degree sequence-based recognition characterizations are of two types depending on whether at least one or all the realizations of the degree sequence satisfy the given conditions. The latter is known as *degree sequence characterization*, that is, it tells us whether a graph belongs to the graph class solely based on its degree sequence. The class of graphs that have a degree sequence characterization is closed under the 2-switch operation. Note that a degree sequence characterization is different from forcibly P -graphic characterization (which we shall not cover here): the former characterizes graph classes whereas the latter characterizes the degree sequences. Standard, but old, surveys are by Hakimi and Schmeichel [HS78] (in 1978) and Rao [Rao81b] (in 1980).

The result on trees is folklore. In 1979, Beineke and Schmeichel [BS79] characterized degree sequences of graphs with one cycle. It was generalized to cacti graphs by Rao [Rao81a] in 1981. Much later in 2005, Býřkořlu [Biy05] further generalized this result to Halin graphs. Bose et al. [BDK⁺08] characterized degree sequences of 2-trees in 2008.

Moving on to other graph classes, Hammer and Simeone [HS81] in 1981, and Merris [Mer03] in 2003 gave a degree sequence characterization of split graphs resulting in a linear time recognition algorithm. Here we note two things (1) if G is a split graph, then every graph with the same degree sequence as G is also a split graph; and (2) the degree sequence of a split graph

does not determine the graph up to isomorphism. However, in the case of *threshold graphs*, Hammer and others [CH73, HIS78], in 1973 and 1978 respectively, gave a degree sequence characterization exploiting the fact that the structure of the threshold graph is completely described by its degree sequence.

2.6.5 Acknowledgements

We thank Prof. Douglas B. West for two reasons: (1) a question on 3-colorability of line arrangement graphs in the coloring chapter of his book “Introduction to Graph Theory” [Wes01], which was how the question on the degree sequences came into shape, and (2) his encouragement to pursue the line arrangement graph realization problem during a conversation at the ICGTA conference in 2015. We thank the organizers of ICGTA 2015.

We also thank Dibyayan Chakraborty for suggesting to study algorithmic questions on eccentricity, which was the starting point for the combinatorial queries on eccentricities of arrangement graphs studied here. The algorithmic study of eccentricities of planar graphs are of interest in the algorithm community.

We thank the reviewers of the earlier paper version of this chapter for helpful suggestions that greatly enhanced both the content and the presentation. In particular, we thank a reviewer of the journal *Computational Geometry: Theory and Applications* for suggesting notable improvements particularly in the proof of [Theorem 2](#), which made it simpler to extend to pseudoline arrangement graphs.

A special thanks to Joydeep Mukherjee for instilling the topological way of thinking in me, without which the results of this chapter would have dealt only with the line arrangement graphs.

This work was partially supported by the IFCAM project “Applications of graph homomorphisms” (MA/IFCAM/18/39).

3 Outerstring graphs of girth five are 3-colorable

Contents

3.1	Introduction	71
3.1.1	Coloring problems	72
3.1.2	The Frameworks of Kostochka and Nešetřil	73
3.1.3	Problems and Results	74
3.2	Preliminaries for grounded-L graphs	77
3.3	Proofs of Theorem 3 and Theorem 4	79
3.3.1	Grounded-L representations of Cycles	79
3.3.2	The target degree two vertex	80
3.4	Tools, Definitions and Notations	83
3.4.1	Tools from Topological graph theory	83
3.4.2	Basic Definitions	84
3.4.3	Specific Definitions	85
3.5	Outline of The Main Proof	89
3.6	Outer 1-string Representation of Cycles	90
3.7	Outer 1-string Representations and Branching Argument	94
3.8	A Stronger Claim and its Proof	95
3.9	Tools, Definitions and Notations	110
3.9.1	Basic Definitions	110
3.9.2	Specific Definitions	110
3.10	Outerstring Representation of Cycles	115
3.11	Outerstring Representations and Branching Argument	120
3.12	A Stronger Claim and its Proof	121
3.13	Consequences of Theorem 8	135
3.14	Final Remarks	138
3.14.1	Acknowledgements	138

3.1 Introduction

First, we recall the necessary definitions.

A *curve* or *string* is a homeomorphic image of the interval $[0, 1]$ in the plane. A *string graph* is the intersection graph of a finite collection of strings.

This collection of strings is the *string representation* of the string graph. We are interested in the following subclasses of string graphs. When two strings in a string representation intersect at most once, the resulting intersection graph is a *1-string graph*. An *outerstring graph* is the intersection graph of curves that are contained in a halfplane with one endpoint of each string in the boundary of the halfplane. When two strings in an outerstring representation intersect at most once, the resulting intersection graph is an *outer 1-string graph*. A *grounded-L graph* is an intersection graph of L's that have their top most points on the horizontal grounding line. We use the following equivalent definition obtained by a homeomorphism of the plane. A *grounded-L graph* is an intersection graph of L's that have their right most points on the vertical grounding line.

Recall that we can safely assume the following conditions in the string representation: (1) strings are *simple*, that is, non-self-intersecting, (2) all the intersection points and ends of strings are distinct, and (3) strings cross at the intersection points.

3.1.1 Coloring problems

In the realm of classical graph theory, many interesting questions on the vertex chromatic number are well-studied. An important question addressed is as follows: Given a graph class \mathcal{G} , whether the maximum chromatic number of a graph $G \in \mathcal{G}$ is bounded in terms of other graph parameters? This resulted in two main contrasting lines of research. The first, which was initiated in the 40's, resulted in various constructions of triangle-free graphs with arbitrarily high chromatic number (first by Zykov [Zyk49] in 1949; more popularly by Mycielski [Myc55] in 1955, among others). In contrast, the other direction led to the study of *perfect graphs* and χ -*boundedness*¹.

If one restricts to the field of geometric intersection graphs, then also many interesting problems on the vertex chromatic number have been studied. Here the two contrasting line of questions were initiated in the 60's. A surprising construction of Burling [Bur95] resulted in triangle-free inter-

¹A *hereditary* graph class \mathcal{G} is said to be χ -*bounded* if there exists a *binding function* $f : \mathbb{N} \rightarrow \mathbb{N}$ that $\chi(G) \leq f(\omega(G))$, for any graph $G \in \mathcal{G}$. By hereditary graph class, we mean closed under taking isomorphisms and taking induced subgraphs. Geometric intersection graphs are hereditary.

section graphs of three-dimensional boxes with arbitrarily high chromatic number. In contrast, in 1960, Asplund and Grünbaum [AG60] initiated the study of χ -boundedness on geometric intersection graphs by proving that the intersection graphs of rectangles are χ -bounded. There is a very rich line of work that resulted from this notion [Mc00a, RW19b, RW19a] (also see [SS20]). Another set of problems study the dependence of chromatic number on girth [KN98]. In this part of the thesis, we contribute to this line of research.

In 1998, Kostochka and Nešetřil [KN98] showed that the chromatic number of 1-string graphs with girth at least five is bounded by a small constant (at most by six). This is surprising as then it was not known whether the chromatic number of segment graphs and 1-string graphs with girth four are bounded or not. These questions were asked by Erdős, and by Kratochvíl and Nešetřil, respectively. Another highlight of their result is the elegance of the proof (see Chapter 5).

We aim to improve the bounds by Kostochka and Nešetřil [KN98] on coloring 1-string graphs with girth five. Our first step is to resolve the problem for outer 1-string graphs with girth five. Here we are not just solving the problem for a subclass, rather, as explained later in subsection 3.1.3 (and also earlier in subsection 1.3.2), this result is the first step in attacking the main problem. In this chapter, we prove that outer 1-string graphs with girth five are 3-colorable. In fact, we prove a more general result for outerstring graphs with girth five. But, first, we frame the problem following Kostochka and Nešetřil [KN98].

3.1.2 The Frameworks of Kostochka and Nešetřil

As mentioned earlier the following type of questions are well-studied. Given a graph class \mathcal{G} , find the maximum chromatic number of a graph $G \in \mathcal{G}$ in terms of other parameters. The initial research on chromatic number of geometric intersection graphs was on χ -boundedness. Many other interesting problems on the chromatic number of intersection graphs of geometric objects have been studied. These problems fall into the following two frameworks as proposed by Kostochka and Nešetřil [KN98, KN02]. The questions on χ -boundedness give an upperbound to the corresponding questions of the

first framework.

The first framework is based on the clique number. Given a class of intersection graphs \mathcal{G} and a positive integer k , with $k \geq 2$, find or bound $\chi_\omega(\mathcal{G}, k)$, where

$$\chi_\omega(\mathcal{G}, k) := \max_{G \in \mathcal{G}} \{\chi(G) \mid \omega(G) \leq k\}.$$

The second framework is based on the girth. Given a class of intersection graphs \mathcal{G} and a positive integer k , with $k \geq 4$, find or bound $\chi_g(\mathcal{G}, k)$, where

$$\chi_g(\mathcal{G}, k) := \max_{G \in \mathcal{G}} \{\chi(G) \mid \text{girth}(G) \geq k\}.$$

A straight-forward observation (see [KN98]) is that $\chi_g(\mathcal{G}, 4) = \chi_\omega(\mathcal{G}, 2)$, as both represent the maximum possible value of chromatic number of triangle-free graphs in \mathcal{G} . In fact, one can easily extend this observation to the following.

Observation 6. *For $k \geq 4$, $\chi_g(\mathcal{G}, k) \leq \chi_\omega(\mathcal{G}, 2)$.*

3.1.3 Problems and Results

One of the popular problems in this regard was posed by Erdős (see [Gyá87, Problem 1.9]) in the 1970s² who asked whether SEGMENT is χ -bounded. In the framework of Kostochka and Nešetřil, the question of Erdős can be translated to the following: Is $\chi_g(\text{SEGMENT}, 4) < \infty$ (Problem 1 in [KN98]). Further, Kratochvíl and Nešetřil asked a similar problem (see [KN95]): Is $\chi_g(1\text{-STRING}, 4) < \infty$? (Problem 2 in [KN98].)

However, recently these questions were resolved in the negative by Pawlick et al. [PKK⁺14]. They proved that $\chi_g(\text{SEGMENT}, 4)$ can be arbitrarily large by constructing triangle-free segment intersection graphs with arbitrarily high chromatic number. In contrast, results are different for such graph classes of girth at least five.

Earlier, motivated by the above problems, Kostochka and Nešetřil [KN98] studied 1-string graphs with girth at least five. In particular, they proved that $\chi_g(1\text{-STRING}, 5) \leq 6$. They also posed whether $\chi_g(1\text{-STRING}, 5) > 3$. Hence, the best known bounds are $3 \leq \chi_g(1\text{-STRING}, 5) \leq 6$.

²An approximate date was confirmed in a personal communication with András Gyárfás and Janós Pach to Pawlick et al. [PKK⁺14] (See footnote 2 there).

Our main objective is to improve the bounds of $\chi_g(1\text{-STRING}, 5)$. To this end, our first step is to find $\chi_g(\text{OUTER } 1\text{-STRING}, 5)$. A standard way of dealing with geometric intersection graphs with girth five is via degeneracy. While working on outer 1-string graphs of girth five, we prove that they are 2-degenerate. Studying degeneracy in outer 1-string graphs is a natural approach in improving the upper bound of $\chi_g(1\text{-STRING}, 5)$ due to the following reason. Given a 1-string representation (with girth $g \geq 5$), we can treat its *envelope*³ as the boundary of the disk containing the outer 1-string representation. The graph induced by the other strings intersecting this *envelope* is an outer 1-string graph. As we shall see, the target string (corresponding to the vertex with degree at most two) in an outer 1-string representation is in some sense *closest* to the boundary. This would result in finding a degree three vertex in the 1-string graph (because of the girth restriction) and hence proving them to be 4-colorable. There are some hidden details. We shall address this in a future work.

Our result on outer 1-string graph of girth at least five generalizes a result of Ageev [Age99] that circle graphs of girth at least five are 2-degenerate. Also, we are able to strengthen our result to generalize a result of Esperet and Ochem [EO09] that circle graphs of girth g at least five and minimum degree at least two have $(g - 4)$ vertices of degree two that induce a path.

Following the theme of this thesis, we first solve this problem in a geometric setup. We first study the corresponding problems on grounded-L graphs of girth at least five. We then extend some of the ideas to prove the results for outer 1-string graphs of girth at least five, and then further to outerstring graphs of girth at least five.

The main result is restated below.

Theorem 8. *Outerstring graphs with girth $g \geq 5$ and minimum degree $\delta \geq 2$ contains a chain of $(g - 4)$ vertices of degree two.*

The rest of this chapter is divided into three parts. In the first part, we prove [Theorem 4](#) (for grounded-L graphs). In the second part, we prove [Theorem 6](#) (for outer 1-string graphs). And, in the third part, we prove [Theorem 8](#).

³Think of the envelope as the boundary of the outerface of the arrangement formed by the strings (recall our assumption that the end points of each string are intersection points).

Part: GROUNDED-L GRAPHS

We first solve this problem in a geometric setup. Outer 1-string graphs have two standard geometric analogues: *grounded-segment* and *grounded-L*. An *grounded-segment graph* is the intersection graph of line segments in a half-plane with an endpoint of each segment on the boundary. Recall the equivalent definition of a *grounded-L graph*, that is, the intersection graph of L shapes such that the rightmost point of the horizontal line segment of each L shape lies on a vertical line. We consider the route via grounded-L graphs, probably because handling two axis-aligned line segments seemed easier than handling one segment of arbitrary slope. The class of grounded-L graphs are contained in the class of grounded-segment graphs (see Jelínek and Töpfer [JT19]). Hence, one might expect that dealing with the geometry in grounded-L graphs to be easier than to deal with grounded-segment graphs. The following also indicates an advantage of using the L's instead of segments. In 1984, in his Ph.D. thesis [Sch84], Scheinerman conjectured that every planar graph is the intersection graph of some segments in the plane. This was proved in 2009 in a breakthrough paper [CG09] by Chalopin and Gonçalves. In 2018, Gonçalves, Isenmann and Pennarun [GIP18] proved that planar graphs are L-intersection graphs, which gave a much simpler and elegant proof of the Scheinerman's conjecture.

Finally, similar questions on grounded-L graphs are well-studied [Mc96]. A result of McGuinness [Mc96] on χ -boundedness of grounded-L graphs implies that triangle-free graphs grounded-L graphs have chromatic number at most 2^{14} .

The use of geometry allows us to solve our problem in two ways. Later, we extend these ideas to outer 1-string graphs, and then to outerstring graphs.

We have seen in the introduction of this chapter that a popular way of handling girth five graphs is via degeneracy. Pursuing this approach for grounded-L graphs with girth five leads us to [Theorem 3](#), which is restated here for convenience.

Theorem 3. *Grounded-L graphs with girth five are 2-degenerate.*

Using a standard greedy coloring scheme, [Theorem 3](#) implies that grounded-L graphs with girth five are 3-colorable. Since odd cycles are also grounded-L graphs, there are grounded-L graphs with girth five that have chromatic number 3. Hence we have the [Corollary 1](#), restated here.

Corollary 1. $\chi_g(\text{GROUNDED-L}, 5) = 3$

Later in this chapter, we extend these results to outer 1-string graphs (as well as outerstring graphs), keeping our hopes alive of improving the bounds of $\chi_g(1\text{-STRING}, 5)$ by Kostochka and Nešetřil [[KN98](#)].

[Theorem 3](#) also generalizes a result of Ageev [[Age99](#)], who proved that circle graphs are 2-degenerate (a separating example is shown in [Chapter 1: Figure 1.4](#) and [Figure 1.5](#)). In fact, in [Theorem 4](#), we strengthen [Theorem 3](#) to generalize a result of Esperet and Ochem [[EO09](#)] on circle graphs, who generalized the above result of Ageev.

Theorem 4. *Grounded-L graphs with girth $g \geq 5$ and minimum degree $\delta \geq 2$ contains a chain of $(g - 4)$ vertices of degree two.*

We begin with some preliminaries on grounded-L graphs (with girth five or otherwise) in [Section 3.2](#). It contains a crucial observation that each face in a grounded-L representation of a grounded-L graph with girth five corresponds to an induced cycle in the graph. In [Section 3.3](#), we prove [Theorem 3](#) and [Theorem 4](#). We start by studying grounded-L representations of cycles of order at least five in [subsection 3.3.1](#). Then in [subsection 3.3.2](#), we find the target vertex (a vertex of degree 2), using two methods: one using simple geometric properties, and another using an acyclic ordering on the faces of the representation. Then, using either of these techniques, we finally prove [Theorem 4](#).

3.2 Preliminaries for grounded-L graphs

We assume that in a grounded-L representation, the rightmost point of the horizontal segment of each L lies on a common vertical line l , which we can safely assume to be the Y-axis (fix the standard coordinate axis system). Thus, the whole grounded-L representation lies in the halfplane $x \leq 0$ ⁴.

⁴We stick to this notation to maintain consistency with the outerstring representations.

Let G be a grounded-L graph with grounded-L representation \mathbb{G}_L . Let v_i be a vertex of G . Let L_i be the L in \mathbb{G}_L representing vertex v_i in G . Since we follow the standard coordinate axis system, the notions of *left*, *right*, *top* and *bottom* are well-defined. The *level* of an L in \mathbb{G}_L is the Y-coordinate of its horizontal segment. Given a v_1v_2 -path in G , we have an unique L_1L_2 -path in \mathbb{G}_L which contains just one point of L_1 and L_2 (the uniqueness follows as two intersecting L's have just one point in common). Given a face in \mathbb{G}_L , consider the L's that share a contiguous part of the face. We call them the *bounding* L's of the face. We claim that these bounding L's induce a cycle in G .

Observation 7. *The vertices corresponding to the bounding L's of a face \mathcal{F} in the grounded-L representation \mathbb{G}_L of a grounded-L graph G with girth $g \geq 5$ form an induced cycle in G .*

Outline of a Proof. Consider the cyclic sequence of the bounding L's obtained while traversing the boundary of \mathcal{F} in a clockwise manner. Let L_t denote the bounding L with the maximum level. Similarly, let L_b denote the bounding L with the minimum level.

We begin by showing that each of the L's in the sequence are distinct. Suppose some L_i is repeated. First, we claim that the two L_tL_b -paths along the boundary of \mathcal{F} are y -monotone. This happens as all the horizontal segments of L meet the stab line. This implies that the horizontal segment of any L is not repeated. Second, we claim that the vertical segment of any L is not repeated. Otherwise, a triangle is induced along with the two next L's in the sequence. Lastly, we claim that the horizontal and then the vertical segment of any L is not repeated (at different parts of the sequence). This is because all the horizontal segments of L meet the stab line. Hence, each of the L's in the sequence are distinct.

It remains to show that two bounding L's that are not consecutive in the cyclic sequence do not intersect. Suppose L_i and L_j be such bounding L's that intersect. Without loss of generality, assume that the vertical segment of L_j intersects the horizontal segment of L_i . Due to girth restrictions there are at least three L's in the cyclic sequence between L_i and L_j . Let them be L_{i+1} , L_{i+2} and L_{i+3} . If L_{i+1} intersects the horizontal segment of L_i , then a triangle is induced by L_i , L_{i+1} and L_j . If L_{i+1} intersects the vertical segment of L_i , then a cycle of length four is induced by L_i , L_{i+1} , L_{i+2} and L_j . These both

cases contradicts our girth assumption. Hence only the consecutive L's in the sequence intersect.

This completes the outline of the proof. \square

The *span* of a face is the maximum of the difference of the levels of two bounding L's of the face.

3.3 Proofs of Theorem 3 and Theorem 4

3.3.1 Grounded-L representations of Cycles

We begin by studying the structure of grounded-L representation \mathbb{C}_L of a cycle C on $n \geq 5$ vertices. Let the vertex set of C be $\{v_1, \dots, v_n\}$, and let L_i denote the L in \mathbb{C}_L that represents v_i . The edge set of C depends on how the L's in \mathbb{C}_L intersect. Since degree of each v_i is two, there are exactly two intersection points in each L_i . Also there are exactly n intersection points in \mathbb{C}_L .

Let L_t denote the L in \mathbb{C}_L that has the maximum level. Similarly, let L_b denote the L in \mathbb{C}_L that has the minimum level. Hence the intersection points on L_t lies in its horizontal segment, and the intersection points on L_b lies in its vertical segment. Let $N(L_t) = \{L_l, L_r\}$ such that the intersection point $L_t \cap L_l$ lies to the left of the intersection point $L_t \cap L_r$. The *block* of \mathbb{C}_L is the rectangular region bounded by L_t , L_l and the grounded line (the Y-axis).

Since C is a cycle there are two internally disjoint $v_t v_b$ -paths, and hence two disjoint $L_1 L_2$ -paths, which we denote as P_l and P_r . Assume that P_l contains some part of L_l , and P_r contains some part of L_r . Hence at any level the point on P_l is to the left of the point on P_r , provided they exist: else, they intersect at an internal point, contradicting that C is a cycle .

Configuration 1: If L_t intersects L_b , then we claim that $L_b = L_l$. Otherwise, $L_b = L_r$ and then a triangle is induced by $N[L_t]$, contradicting $n \geq 5$. In this case, all the corner points except that of $N[L_b]$ lie in the block (as the L whose corner point is not in the block will intersect L_b).

Configuration 2: If L_t does not intersect L_b , then we claim that L_b intersects L_l , that is, P_l contains only a part of L_l . Suppose not, then any part of

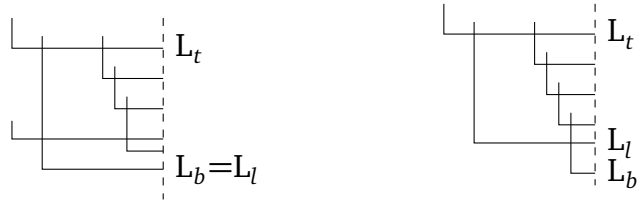

Figure 3.1: Configurations 1 and 2.

L_b does not lie in the block of \mathbb{C}_L . Consider the path P_r and the corresponding v_t, v_b -path via v_r . L_l intersects some internal L in P_r . This implies that v_l intersects some internal vertex in v_t, v_b -path via v_r , contradicting that C is a cycle. Thus, L_l intersects L_b .

Irrespective of the above two configurations, we claim that the block completely contains a L . It suffices to show that the L 's that do not lie completely in the block are exactly $N[L_l] \cup L_r$. Any L not in $N[L_l] \cup L_r$ either lies completely in the block or lies completely outside it. In the latter case, we get a contradiction that C is not a cycle (similar to that obtained in the description of configuration 2). Thus, every L other than $N[L_l] \cup L_r$ lies in the block.

Hence $(n-4)$ L 's completely lie in the block. We call them as the *intermediate L's*.

3.3.2 The target degree two vertex

Let \mathbb{G}_L be a grounded- L representation of a grounded- L graph G with girth $g \geq 5$. We can safely assume that $\delta = 2$. Also, as GROUNDED- L is closed under taking subgraphs, it is enough to show that there is a degree-2 vertex in G . We give two approaches: one via simple geometric observations, and another via an acyclic relation.

First approach: Maximum face

Choose the face \mathcal{F}_0 in \mathbb{G}_L with the following criteria: choose the one where the smallest X -coordinate of any point in the face is maximum (that is, corner point of L_l of \mathcal{F}_0 has maximum X -coordinate), and among the faces that tie with respect to this criteria, choose the one whose area of the block is minimum. Consider its bounding L 's. They induce a cycle in G . Fix an intermediate L , denoted by L_{int} .

We claim that L_{int} has degree two. Else, suppose $|N(L_{int})| \geq 3$. Then

there is an L in $N(L_{int})$ that is not in the induced cycle. Then to satisfy $\delta \geq 2$, there is another L intersecting it. Iteratively, this goes on till a new face \mathcal{F}_1 is formed. If a new face is not formed, then the new L 's added induce a tree and has at least two leaves: only one of which intersects an L bounding \mathcal{F}_0 . This contradicts the $\delta \geq 2$ condition. (We call this line of argument as a *branching argument*.)

Next, we compare \mathcal{F}_0 and \mathcal{F}_1 with respect to our criteria. The face \mathcal{F}_1 lies in a face (other than \mathcal{F}_0) of the arrangement of the bounding L 's of \mathcal{F}_0 and the stab line. Hence, the only face in the arrangement where \mathcal{F}_1 can belong to (creating a tie with respect to the first criteria) is if the bounding L 's of \mathcal{F}_0 induce a configuration 1 and \mathcal{F}_1 lies with block bounded by L_l of \mathcal{F}_0 and the other bounding L of \mathcal{F}_0 that L_l intersects other than L_t of \mathcal{F}_0 . However, in this case the second criteria contradicts the choice of \mathcal{F}_0 , as the block of \mathcal{F}_0 contains the block of \mathcal{F}_1 .

Hence, L_{int} has degree two. This ends the proof of [Theorem 3](#) □

An alternative approach: Maximal face — acyclic relation

Let $\{\mathcal{F}_i\}$ be the set of faces in \mathbb{G}_L . Given two distinct faces \mathcal{F}_1 and \mathcal{F}_2 , define a relation $\mathcal{F}_1 \prec \mathcal{F}_2$ if $\mathcal{F}_2 \subset \text{block}(\mathcal{F}_1)$. Next, we show that the relation \prec is an acyclic relation.

Suppose $\mathcal{F}_1 \prec \mathcal{F}_2 \prec \cdots \prec \mathcal{F}_i \prec \mathcal{F}_1$. We know that $\mathcal{F}_1 \prec \mathcal{F}_2$ if $\mathcal{F}_2 \subset \text{block}(\mathcal{F}_1)$. We claim that it also implies that $\text{block}(\mathcal{F}_2) \subset \text{block}(\mathcal{F}_1)$. It suffices to show that both \mathcal{F}_1 and \mathcal{F}_2 do not have the same L_t and L_l . Consider the L_t and L_l of \mathcal{F}_1 . Suppose both \mathcal{F}_1 and \mathcal{F}_2 have the same L_t . In both configuration 1 and 2, the face \mathcal{F}_2 is restricted to be in the region bounded by L_t and L_r of \mathcal{F}_1 , else \mathcal{F}_1 is no more a face in \mathbb{G}_L . Also L_r does not intersect L_l , else a triangle is induced. Thus, L_l cannot be a bounding L of \mathcal{F}_2 . Hence, both \mathcal{F}_1 and \mathcal{F}_2 do not have the same L_t and L_l , and hence, $\text{block}(\mathcal{F}_2) \subset \text{block}(\mathcal{F}_1)$. This implies that $\text{block}(\mathcal{F}_1) \subset \text{block}(\mathcal{F}_2) \subset \cdots \subset \text{block}(\mathcal{F}_i) \subset \text{block}(\mathcal{F}_1)$, a contradiction.

Hence, \prec is an acyclic relation. Therefore, there is at least one maximal element. Consider such a maximal face \mathcal{F}_m . The intermediate- L 's in this face induce the required chain. Else if some intermediate- L , say L_{int} , has degree three, then by a *branching argument* (see the corresponding part in the pre-

vious approach while respecting $\delta = 2$) a new face is formed that contradicts the maximality of \mathcal{F}_m .

Hence, L_{int} has degree two. This ends the proof of [Theorem 3](#). \square

Proof of [Theorem 4](#). In the above proof of [Theorem 3](#) (in both the approaches), since L_{int} was chosen randomly among the intermediate L's of \mathcal{F}_0 , all the intermediate L's of \mathcal{F}_0 have degree two. Hence, every grounded-L graph with girth $g \geq 5$ and $\delta \geq 2$ will have a $(g - 4)$ -chain of degree two vertices. \square

This completes the part of this chapter on grounded-L graphs.

Part: OUTER 1-STRING GRAPHS

Using the idea of intermediate-L's we can extend the results on grounded-L graphs to prove the corresponding results on outer 1-string graphs. The use of geometry in grounded-L representations allowed us to follow our approach of attack in two ways. Using a nice inductive framework, we are able to extend one of these ways to prove the generalized result of Esperet and Ochem [EO09] for outer 1-string graphs, and later to outerstring graphs. We begin by restating [Theorem 5](#), which is pivotal to our strategy to solve the main problem on 1-string graphs of girth five by Kostochka and Nešetřil [KN98].

Theorem 5. *Outer 1-string graphs with girth five are 2-degenerate.*

Using a standard greedy coloring scheme, [Theorem 5](#) implies that outer 1-string graphs with girth five are 3-colorable. Since odd cycles are also outer 1-string graphs, there are outer 1-string graphs with girth five that have chromatic number 3. Hence we have the [Corollary 2](#), restated here.

Corollary 2. $\chi_g(\text{OUTER 1-STRING}, 5) = 3$.

[Theorem 5](#) also generalizes a result of Ageev [Age99], who proved that circle graphs are 2-degenerate (a separating example is shown in [Chapter 1: Figure 1.4](#)). In fact, in [Theorem 6](#), we strengthen [Theorem 5](#) to generalize a result of Esperet and Ochem [EO09] on circle graphs, who generalized the above result of Ageev.

Theorem 6. *Outer 1-string graphs with girth $g \geq 5$ and minimum degree $\delta \geq 2$ contains a chain of $(g - 4)$ vertices of degree two.*

We shall prove [Theorem 6](#) only, as the other two results are its corollaries. Also, it suffices to consider only connected outer 1-string graphs.

3.4 Tools, Definitions and Notations

3.4.1 Tools from Topological graph theory

The proof of [Theorem 6](#) is topological in nature, relying on the Jordan Curve Theorem (see [MT01]) and its corollaries. A *simple* curve is a non self-

intersecting curve. A *Jordan curve* is a simple closed curve in the plane.

Theorem 13 (Jordan Curve Theorem). *Any continuous simple closed curve \mathcal{C} in \mathbb{R}^2 partitions $\mathbb{R}^2 \setminus \mathcal{C}$ into two regions: the inside and the outside.*

By definition, both inside and outside regions are *open*. In contrast, *closed inside region* means the inside region along with the Jordan curve. For an closed region \mathcal{R} , its inside region (got after removing its boundary) is denoted by $Int(\mathcal{R})$. By slight abuse of notation, for a Jordan curve \mathcal{C} , the region inside it is also denoted as $Int(\mathcal{C})$.

As a consequence of the Jordan Curve Theorem, any curve joining a point in the inside region of \mathcal{C} to a point in the outside region of \mathcal{C} will intersect \mathcal{C} . We shall use this along with the following corollary (see [MT01]) in our proofs.

Corollary 6. *Let \mathcal{C} be a simple closed curve in the plane, and let \mathcal{P} be a simple curve joining distinct points $p, q \in \mathcal{C}$ such that $\mathcal{P} \cap \mathcal{C} = \{p, q\}$. Let S_1, S_2 be the two segments of \mathcal{C} from p to q . Then $\mathcal{C} \cup \mathcal{P}$ in \mathbb{R}^2 has precisely three faces whose boundaries are \mathcal{C} , $\mathcal{P} \cup S_1$ and $\mathcal{P} \cup S_2$.*

A proof of the Jordan Curve Theorem can be found in Mohar and Thomassen [MT01, p. 18–25]. Corollary 6 says that the inside region or the outside region of \mathcal{C} is divided into two parts by \mathcal{P} . In particular, the inside region or, respectively, the outside region of \mathcal{C} is no longer a face. Corollary 6 can be proved using the Jordan Curve Theorem, by following the arguments of Corollary 2.1.4 in Mohar and Thomassen [MT01, p. 20].

3.4.2 Basic Definitions

Recall that an outer 1-string graph is the intersection graph of curves that pairwise intersect at most once and are contained in a halfplane with one endpoint in the boundary of the halfplane. This boundary is called the *grounding line* of the representation. We assume the grounding line in the outer 1-string representation to be the Y-axis and the strings to lie in the halfplane $x \leq 0$.

For an outer 1-string graph OS_1 , we denote its outer 1-string representation as $\mathbb{O}S_1$ (see Figure 3.2a for an outer 1-string representation of the cycle C_7). For each string s_i in $\mathbb{O}S_1$, its endpoint on the grounding line is its *fixed*

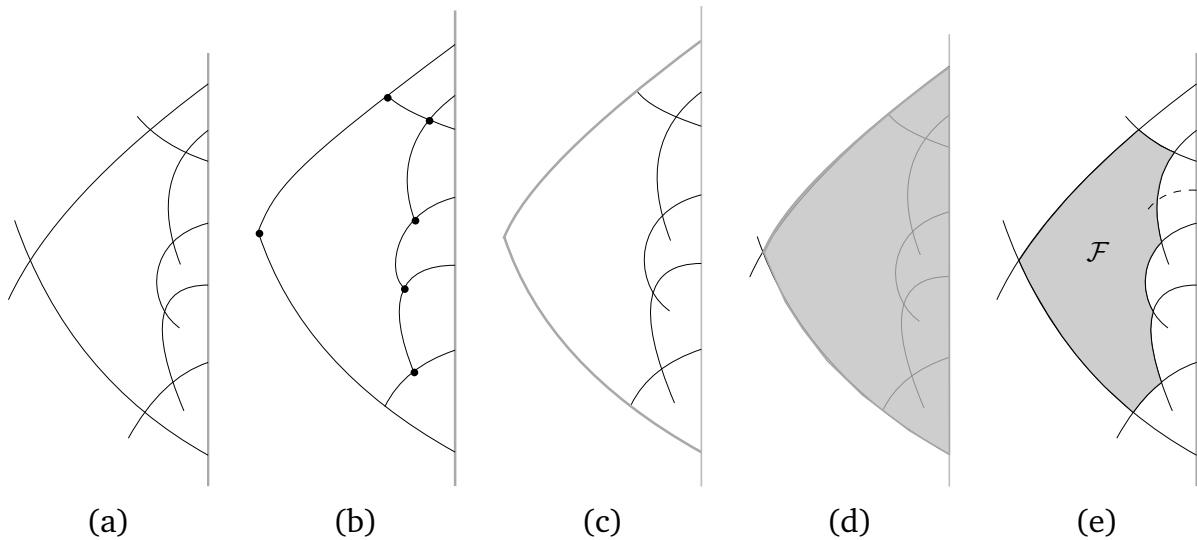

Figure 3.2: (A, B) Outer 1-string representations, (C) Left envelope (highlighted), (D) Zone (shaded), and (E) k -face (shaded).

end and the other endpoint is its *free end*. We can safely assume that all the free ends of the strings are intersection points (see Figure 3.2b)⁵. We relax the *crossing* assumption at these points. Since the grounding line is the Y-axis, we can order all the fixed ends of strings; so the terms *above*, *below*, *topmost* and *bottommost* are well-defined. The outer 1-string representation induced by a subset of strings in \mathcal{OS}_1 is called its *sub-representation*.

A region $\mathcal{A} \subset \mathbb{R}^2$ is *arc-connected* if for any two points in \mathcal{A} there is a curve lying completely in \mathcal{A} that connects them. A *face* in \mathcal{OS}_1 is a maximal arc-connected component of $\mathbb{R}^2 \setminus \bigcup s_i$. (Here the ambient space is \mathbb{R}^2 and not the halfplane $x \leq 0$.) An *arrangement* induced by a set of curves in \mathbb{R}^2 is the embedding of these curves in \mathbb{R}^2 .

A n -*chain* in \mathcal{OS}_1 is a path of length $n + 1$ in \mathcal{OS}_1 whose n internal vertices have degree two in \mathcal{OS}_1 . By abuse of notation, we shall also call the corresponding representation in \mathcal{OS}_1 as a n -*chain*.

3.4.3 Specific Definitions

We shall now start defining some specific terms that we need in this article. The first definition is a part of the “envelope” of \mathcal{OS}_1 , and the rest are regions in \mathcal{OS}_1 .

⁵For sake of clarity, we ignore this assumption while drawing figures.

Left Envelope

In \mathbb{OS}_1 , let t_0 (respectively, b_0) be the topmost fixed end (respectively, bottommost fixed end) of \mathbb{OS}_1 . Let t_0b_0 be the line segment (on the grounding line) from t_0 to b_0 . Consider the arrangement induced by the strings in \mathbb{OS}_1 and t_0b_0 in \mathbb{R}^2 . Consider the unbounded face of this arrangement. It exists as OS_1 is connected. The *left envelope* of \mathbb{OS}_1 is the part of the boundary of this unbounded face after removing $t_0b_0 \setminus \{t_0, b_0\}$, that is, t_0b_0 except its end points (see [Figure 3.2c](#)). We say a string s belongs to the left envelope \mathcal{E} if $s \cap \mathcal{E} \neq \emptyset$. Similarly, we can define the left envelope of a connected sub-representation of \mathbb{OS}_1 .

Zone

This region is about a collection of faces in the arrangement induced by the strings of \mathbb{OS}_1 and the grounding line, specific to any two intersecting strings. In an outer 1-string representation, consider two intersecting strings s_t and s_b with the fixed end of s_t above the fixed end of s_b . The *zone* of s_t and s_b in \mathbb{OS}_1 is the bounded closed face in $\mathbb{R}^2 \setminus \{s_t, s_b, tb\}$ that contains tb in its boundary (see [Figure 3.2d](#)). The strings s_t and s_b are called as the *defining strings* of this zone: with s_t as its *top defining string* and s_b as its *bottom defining string*. Thus every pair of intersecting strings correspond to a zone.

A zone \mathcal{Z} of s_t and s_b is *filled* if there exists a string s in \mathbb{OS}_1 whose fixed end is in \mathcal{Z} , and s does not intersect with s_t and s_b . That is, $s \cap \mathcal{Z} = s$ and $s \cap s_t = s \cap s_b = \emptyset$; we say that \mathcal{Z} *supports* s .

k -Face.

In an outer 1-string graph OS_1 with girth $g \geq 5$, let \mathcal{F} be a bounded face in \mathbb{OS}_1 . Form the cyclic sequence of strings encountered while traversing the boundary of \mathcal{F} with the following restriction. Ignore the strings that contribute just a point in the boundary of \mathcal{F} . Soon we shall prove that the strings in this sequence do not repeat (see proof of [Observation 8](#)). We call these strings as *bounding strings*. We say \mathcal{F} is a k -face if it has k bounding strings (see [Figure 3.2e](#)).

Clearly $k \geq g$. Indeed, if the sequence obtained is $s_1 s_2 \dots s_k$, then there is a closed curve using these k strings, as s_r intersects $s_{(r \bmod k)+1}$. This implies $k \geq g$, else it contradicts our girth assumption.

Next, we show that the cycle contributed by the k -face \mathcal{F} is an induced cycle in OS_1 .

Observation 8. *The vertices corresponding to the bounding strings of a k -face \mathcal{F} in OS_1 of an outer 1-string graph OS_1 (with girth $g \geq 5$) form an induced cycle in OS_1 .*

Outline of the Proof. We have to prove two parts. First, we have to show that all the strings in the cyclic sequence are distinct. Second, we have to show that only the consecutive strings in the cyclic sequence intersect. This proves that the corresponding vertices of these strings form an induced cycle in OS_1 . The first condition says that there is no cut-vertex and the second condition says that there is no chord in the graph induced by the vertices corresponding to the bounding strings of a k -face.

First, we show that all the strings in the cyclic sequence are distinct. For sake of contradiction, suppose there exists a string s_i that gets repeated, that is, the sequence is $s_1 \dots s_i s_{i_1} s_{i_2} \dots s_{i_l} s_i \dots$ ($i = 1$ is also possible). Recall that adjacent strings in the sequence intersect. So there is a Jordan curve \mathcal{C}_1 formed by parts of strings with the same ordering in the above sequence. To maintain a girth $g \geq 5$ there are at least three strings on each side of the cyclic sequence between the two occurrences of s_i .

Depending on the string s_i we either (1) consider the Jordan curve \mathcal{C}_2 got by tracing s_i instead of $s_{i_1} s_{i_2} \dots$ in \mathcal{C}_1 (that is, \mathcal{C}_2 is formed by strings $s_1 \dots s_i \dots s_1$) such that the inside region of \mathcal{C}_2 contains the inside region of \mathcal{C}_1 , or (2) consider the Jordan curve \mathcal{C}_3 got by tracing s_i and $s_{i_1} s_{i_2} \dots s_{i_l}$ in \mathcal{C}_1 (that is, \mathcal{C}_3 is formed by strings $s_i s_{i_1} s_{i_2} \dots s_{i_l} s_i$) such that the inside region of \mathcal{C}_3 contains the inside region of \mathcal{C}_1 . Observe that these two cases are exhaustive. (See [Figure 3.14](#).)

In the first case, there exists an intersection point $x_{1,2}$ of strings s_{i_1} and s_{i_2} on \mathcal{C}_1 that lies in the inside region of \mathcal{C}_2 . Thus, the part of s_{i_2} from its fixed end to $x_{1,2}$ intersects \mathcal{C}_2 . Also s_{i_2} cannot intersect \mathcal{C}_2 at some string other than s_{i_1} , else \mathcal{F} cannot be a face. Then s_{i_1}, s_{i_1} and s_{i_2} induces a cycle of length three, contradicting our girth assumption.

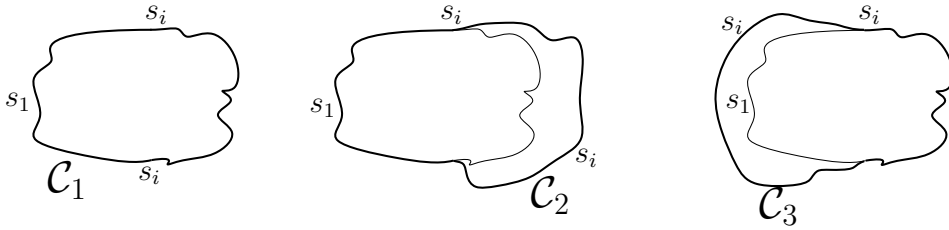

Figure 3.3: Illustration of proof of [Observation 8](#).

In the second case, there exists an intersection point $x_{i-2,i-1}$ of the strings s_{i-1} and s_{i-2} on \mathcal{C}_1 that lies in the inside region of \mathcal{C}_3 . So the part of s_{i-2} from its fixed end to $x_{i-2,i-1}$ intersects \mathcal{C}_3 . Also s_{i-2} cannot intersect \mathcal{C}_3 at some string other than s_i , else \mathcal{F} cannot be a face. Then s_i, s_{i-1} and s_{i-2} induces a cycle of length three, contradicting our girth assumption. (By indices $i-2$ and $i-1$, we mean the indices of the strings before s_i in the cyclic sequence.)

Hence all the bounding strings occur exactly once in the sequence. It remains to show that only the consecutive strings in the cyclic sequence intersect.

Suppose the sequence is $s_1 \dots s_i, s_{i+1} \dots s_j \dots$ with s_i intersecting s_j . To maintain a girth $g \geq 5$ there are at least three strings on each side of the cyclic sequence between s_i and s_j . Then, as above, there will be two cases where either (1) s_{i+2} will intersect either s_i or s_j inducing a cycle of length three or four by the strings s_i, s_{i+1} and s_{i+2} , or s_i, s_{i+1}, s_{i+2} and s_j , respectively, or (2) s_{i-2} will intersect either s_i or s_j inducing a cycle of length three or four by the strings s_i, s_{i-1} and s_{i-2} , or s_i, s_{i-1}, s_{i-2} and s_j , respectively. These contradicts our girth assumption. Hence only the consecutive strings in the cyclic sequence intersect.

Therefore, the vertices corresponding to the bounding strings of \mathcal{F} form an induced cycle in OS_1 . □

Extended Face

In an outer 1-string graph OS_1 with girth $g \geq 5$, consider an induced cycle C on k vertices and an outer 1-string representation \mathbb{OS}_1 . As the strings corresponding to the adjacent vertices intersect, we can find a closed curve in \mathbb{OS}_1 using the parts of strings corresponding to the vertices of C . Since C is an induced cycle, this closed curve is a Jordan curve. Furthermore, this Jordan curve is unique as a pair of strings intersect at most once. We call the closed

inside region of this Jordan curve as the *extended face* of C .

This completes our definitions. We conclude this section by recalling our assumptions: (1) graphs are simple, finite and connected, (2) strings are simple, (3) the free ends of strings are intersection points, (4) strings cross at the intersection points (except for the free ends), and (5) all the intersection points and the fixed ends of the strings are distinct. The fourth assumption is standard in the context of string representations, and we can safely assume the rest.

3.5 Outline of The Main Proof

The proof of [Theorem 6](#), in fact a stronger version of it, consists of three parts. In this section, we give a detailed outline. The main proof is by strong induction. To this end, first, we study the outer 1-string representations of cycles of order n at least five in [Section 3.6](#), which serves as the base step in our induction template. In [Claim 1](#), we show that every outer 1-string representation of a cycle has at least one filled zone, each of which contains a $(n - 4)$ -chain.

Next, in [Section 3.7](#), we study a key property of outer 1-string graphs of girth at least five and minimum degree at least two that each filled zone in any outer 1-string representation of such a graph has a k -face. A key argument used in its proof is the branching argument which is used regularly throughout the main proof.

Finally, in [Section 3.8](#), we frame the stronger statement in [Claim 2](#), which says that in any outer 1-string representation of a outer 1-string graph of girth g at least five and minimum degree at least two, any filled zone completely contains a $(g - 4)$ -chain. This proof goes via induction and has roughly two steps. In the first step, we show that given a filled zone in such an outer 1-string representation, every string has an intersection point in its interior. Else, we prove the existence of a $(g - 4)$ -chain by our induction hypothesis. Now, due to the base step of our induction, we can safely assume that there are two cycles in the graph. In the second step, we prove that the outer 1-string representation has at least two filled zones. This restricts us to two possible configurations, which we prove cannot occur. This proves the required result.

We stick to the above outline as it is easier to extend the proof for outer 1-string graphs to outerstring graphs in this framework. We are sure that proving the result just for outer 1-string graphs, without worrying about extending the proof to outerstring graphs, would be easier.

3.6 Outer 1-string Representation of Cycles

Here we study the structure of outer 1-string representation \mathbb{C} , of a cycle C on $n \geq 5$ vertices. Let the vertex set of C be $\{v_0, v_1, \dots, v_{n-1}\}$, and let s_i denote the string in \mathbb{C} that represents v_i . Without loss of generality, assume that, for $i < j$ the fixed point of s_i lies below the fixed point of s_j . The edge set of C depends on how the strings in $\{s_i : 0 \leq i \leq n-1\}$ intersect. Since degree of each v_i is two, the string s_i in \mathbb{C} contains two intersection points, that is, if v_i is adjacent to v_j and v_k in C , then s_i has two intersection points (s_i, s_j) and (s_i, s_k) . Also, there are exactly n intersection points in \mathbb{C} .

Consider the extended face of C , and let \mathcal{C} be its boundary. We begin with the following observation. Recall that for a closed region \mathcal{R} , its inside region (got after removing its boundary) is denoted by $Int(\mathcal{R})$.

Observation 9. *If the outer 1-string representation \mathbb{C} of cycle C has a filled zone \mathcal{Z} with defining strings s_t and s_b , then every other string s in the representation has an intersection point in $Int(\mathcal{Z})$.*

Proof. The boundary \mathcal{C} of the extended face of cycle C is a Jordan curve on n strings and contains n intersection points. As \mathcal{Z} is a filled zone, it supports a string, say s_j , that is $s_j \cap \mathcal{Z} = s_j$, and s_j does not intersect s_t and s_b .

To the contrary, suppose string s_i has no intersection point in $Int(\mathcal{Z})$. Since C is a cycle, s_i has two intersection points in it. First, we claim that at least one intersection point on s_i lies outside \mathcal{Z} . Suppose both the intersection points in s_i are on the defining strings of \mathcal{Z} (particularly, on the boundary of \mathcal{Z}), that is, there are intersection points between strings s_i and s_t , and between strings s_i and s_b . Then s_i, s_t and s_b induce a cycle of length three, contradicting $n \geq 5$. Thus at least one intersection point on s_i lies outside \mathcal{Z} .

Choose such an intersection point $x_i \in s_i \cap \mathcal{C}$ that lies outside \mathcal{Z} . Also choose an intersection point $x_j \in s_j \cap \mathcal{C}$, which lies in $Int(\mathcal{Z})$. Both x_i and x_j exist as \mathcal{C} contains all the n intersection points. The boundary $\partial\mathcal{Z}$ of \mathcal{Z}

is a Jordan curve, with x_i in the outside region of $\partial\mathcal{Z}$, and x_j in the inside region of $\partial\mathcal{Z}$. Since \mathcal{C} is a Jordan curve, there are two disjoint (simple) curves between x_i and x_j in \mathcal{C} . Both of these x_i, x_j -curves intersect $\partial\mathcal{Z}$. Consider the region in $\text{Int}(\mathcal{C}) \cap \mathcal{Z}$ that contains x_j in its boundary. Denote this region (face) by \mathcal{R} .

The boundary $\partial\mathcal{R}$ of \mathcal{R} is a Jordan curve that does not contain the intersection point x_i . So the vertices corresponding to the strings in $\partial\mathcal{R}$ induces a cycle in C of length less than n . This contradicts our assumption that C is a cycle on n vertices. \square

Using [Observation 9](#), we prove the following claim regarding the number of filled zones in \mathcal{C} . Also see [Remark 6](#) for an important distinction that we will have to consider in the proof of [Theorem 8](#) in [Section 3.8](#).

Claim 1. *There is at least one filled zone in \mathcal{C} . Every filled zone in \mathcal{C} contains a $(n - 4)$ -chain.*

Proof. We begin with an outline. For the first part, we consider three cases. If the two strings with the lowest fixed ends do not intersect, then we show that there is a filled zone. Similarly, if the two strings with the highest fixed ends do not intersect, then we show that there is a filled zone. However, if none of the above two cases occur, that is, each pair of strings discussed above intersect, then we first show that the left envelope has at most four strings (the two pairs of strings). Then we show that two of these strings form a filled zone. For the second part, we use [Observation 9](#) and show that any filled zone has a $(n - 4)$ -chain. Now, we give the complete proof.

Recall that we denote the set of strings in \mathcal{C} by $\{s_0, s_1, \dots, s_{n-1}\}$. Also we assumed that, for $i < j$, the fixed point of s_i lies below the fixed point of s_j .

We have three cases depending on whether s_0 intersects s_1 , and whether s_{n-1} intersects s_{n-2} . If s_0 does not intersect s_1 , then s_1 cannot intersect both the neighbours of s_0 . Else a cycle of length four is induced, contradicting $n \geq 5$. Thus there exists a string s_j such that $s_0 \cap s_j \neq \emptyset$ and $s_1 \cap s_j = \emptyset$. Hence the zone \mathcal{Z} of s_0 and s_j supports s_1 , thereby making \mathcal{Z} a filled zone. Similarly, if s_{n-1} does not intersect with s_{n-2} , then we get a filled zone. Now it remains to consider the case where both s_0 intersects s_1 , and s_{n-1} intersects s_{n-2} .

First, we claim that no string other than $\{s_0, s_1, s_{n-2}, s_{n-1}\}$ belongs to the

left envelope \mathcal{E} of \mathbb{C} . For sake of contradiction, suppose some s_i , for $2 \leq i \leq n-3$, belongs to \mathcal{E} . Consider the minimal part of s_i that joins a point in \mathcal{E} to the fixed end of s_i . (It contains just one point in \mathcal{E} .) This part of s_i partitions the inside region of the Jordan curve formed by \mathcal{E} and (part of) the grounding line into two regions, with this part of s_i as their common boundary (see [Corollary 6](#)). Let \mathcal{R}_1 be the region containing the fixed ends of s_0 and s_1 . And let \mathcal{R}_2 be the region containing the fixed ends of s_{n-2} and s_{n-1} .

The string s_i cannot intersect both s_0 and s_1 , else a cycle of length three is induced by strings s_0 , s_1 and s_i , contradicting $n \geq 5$. Similarly, the string s_i cannot intersect both s_{n-2} and s_{n-1} . Fix $s_{0,1} \in \{s_0, s_1\}$ and $s_{n-2,n-1} \in \{s_{n-2}, s_{n-1}\}$ such that s_i does not intersect $s_{0,1}$ and $s_{n-2,n-1}$. Thus $s_{0,1}$ lies in \mathcal{R}_1 and does not intersect with \mathcal{R}_2 . Similarly, $s_{n-2,n-1}$ lies in \mathcal{R}_2 and does not intersect with \mathcal{R}_1 .

Since \mathcal{C} (i.e. boundary of the extended face of C) has intersection points on all the strings, consider an intersection point x on $s_{0,1} \cap \mathcal{C}$ and another intersection point y on $s_{n-2,n-1} \cap \mathcal{C}$. As \mathcal{C} is a Jordan curve, there are two internally disjoint x, y -curves on \mathcal{C} . Note that x lies in \mathcal{R}_1 and y lies in \mathcal{R}_2 . Any curve in \mathbb{C} that joins an intersection point in \mathcal{R}_1 to an intersection point in \mathcal{R}_2 , intersects s_i . Thus, both of the x, y -curves on \mathcal{C} , intersect s_i . Consider the region in $Int(\mathcal{C}) \cap \mathcal{R}_1$ that contains x in its boundary. Denote this region (face) by \mathcal{R}'_1 . This region \mathcal{R}'_1 contains a part of $s_{0,1}$ in its boundary.

The boundary $\partial \mathcal{R}'_1$ of \mathcal{R}'_1 is a Jordan curve. Note that $\partial \mathcal{R}'_1$ does not contain any intersection point on $s_{n-2,n-1}$ (as $s_{n-2,n-1}$ does not intersect with \mathcal{R}_1). This induces a cycle in C of length less than n . This contradicts our assumption that C is a cycle on n vertices. Hence no string other than $\{s_0, s_1, s_{n-2}, s_{n-1}\}$ belongs to the left envelope of \mathbb{C} .

Recall that we are still in the case where both s_0 intersects s_1 , and s_{n-1} intersects s_{n-2} . The left envelope \mathcal{E} of \mathbb{C} is a continuous curve from the fixed end of s_0 (the bottommost fixed end of \mathbb{C}) to the fixed end of s_{n-1} (the topmost fixed end of \mathbb{C}) using the strings in \mathbb{C} . So both s_0 and s_{n-1} belong to the left envelope of \mathbb{C} . Next we claim that a string from $\{s_0, s_1\}$ intersects with a string from $\{s_{n-2}, s_{n-1}\}$. Else, we cannot have a continuous curve from the fixed end of s_0 to the fixed end of s_{n-1} using strings from $\{s_0, s_1, s_{n-2}, s_{n-1}\}$; but \mathcal{E} is such a curve. Furthermore, there is exactly one string from $\{s_0, s_1\}$ that intersects with one string from $\{s_{n-2}, s_{n-1}\}$, else (respecting the degrees of ν_0, ν_1, ν_{n-2}

and v_{n-1} in C) a cycle of size four is induced, contradicting $n \geq 5$. Consider the zone \mathcal{Z} of these two intersecting strings (one from $\{s_0, s_1\}$ and one from $\{s_{n-2}, s_{n-1}\}$).

The degree constraints for the corresponding vertices of the defining strings of \mathcal{Z} are already satisfied by adjacencies among v_0, v_1, v_{n-2} and v_{n-1} as we already have assumed that v_0 is adjacent to v_1 , and v_{n-2} is adjacent to v_{n-1} . Thus no other strings intersect the defining strings of \mathcal{Z} . All the fixed ends of strings s_i for $2 \leq i \leq n-3$ lie in \mathcal{Z} , as the top defining string of \mathcal{Z} is either s_{n-2} or s_{n-1} and the bottom defining string of this zone is either s_0 or s_1 . Thus \mathcal{Z} supports all strings s_i for $2 \leq i \leq n-3$. Hence \mathcal{Z} is a filled zone. This proves the first part of the claim.

To prove the second part of the claim, consider a filled zone \mathcal{Z}' with defining strings s_p and s_q , with $p < q$. Since \mathbb{C} is an outer 1-string representation of a cycle, each string intersects exactly two other strings. Assume that s_p also intersects $s_{p'}$, and s_q also intersects $s_{q'}$. Now consider a string s_i in \mathbb{C} such that $s_i \notin \{s_p, s_{p'}, s_q, s_{q'}\}$. By [Observation 9](#), s_i has an intersection point in $Int(\mathcal{Z}')$. Also s_i does not intersect s_p and s_q . Thus \mathcal{Z}' supports s_i . Hence \mathcal{Z}' supports all strings other than $s_p, s_{p'}, s_q$ and $s_{q'}$. Since C is a cycle, there are two $v_{p'}, v_{q'}$ -paths: one is $v_{p'}v_p v_q v_{q'}$, and the other has $(n-4)$ internal vertices $V(C) \setminus \{v_p, v_{p'}, v_q, v_{q'}\}$. The filled zone \mathcal{Z}' supports the strings corresponding to all these internal vertices. Thus the strings that are supported by \mathcal{Z}' induce a $(n-4)$ -chain. Therefore, every filled zone in \mathbb{C} contains a $(n-4)$ -chain. \square

It follows from [Claim 1](#) that the left envelope of any outer 1-string representation of a cycle contains at most four strings. Indeed, at least $n-4$ strings are supported by the filled zones and thus will not lie on the left envelope. Hence the left envelope contains at most three intersection points. We summarize this in the following remark.

Remark 6. The left envelope of \mathbb{C} contains at most three intersection points. There are outer 1-string representations where there are one, two, or three intersection points in their left envelope. In the first case (one type of intersection point in the left envelope), there are three filled zones in \mathbb{C} . In the second and third cases (two and three intersection point in the left envelope), there is one filled zone in \mathbb{C} . See [Figure 3.4a](#), [Figure 3.4b](#) and [Figure 3.4c](#), respectively.

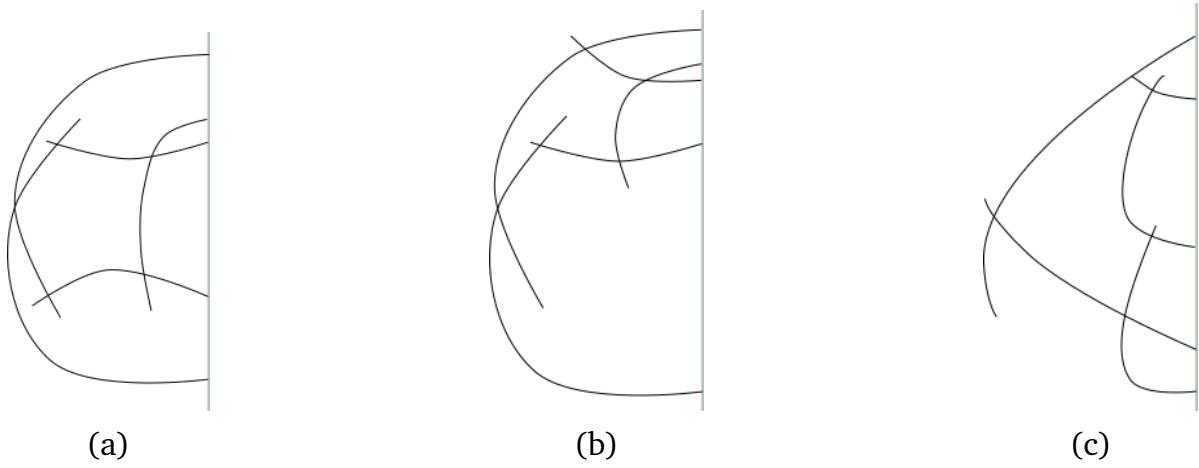

Figure 3.4: Three possibilities of \mathbb{C} with (A) one, (B) two and (C) three intersection points in the left envelope, respectively.

Remark 7. Since each filled zone supports the strings in a $(n-4)$ -chain, every filled zone in \mathbb{C} will contain the k -face corresponding to cycle C .

Definition. We call such strings that are supported by the filled zone as *intermediate strings*. Note that they do not belong to the left envelope, and they induce a $(n-4)$ -chain.

This completes our study of the structure of the outer 1-string representation of a cycle. In the next section we shall study some basic properties of outer 1-string representations with girth $g \geq 5$, followed by proving a stronger version of [Theorem 8](#) in the subsequent section.

3.7 Outer 1-string Representations and Branching Argument

Consider an outer 1-string graph OS_1 with girth $g \geq 5$. Observe that the condition $\delta \geq 2$ in [Theorem 8](#) is necessary. Indeed, degree one vertices can forbid the presence of any chain. Henceforth, we shall concentrate on outer 1-string graphs OS_1 with girth $g \geq 5$ and $\delta \geq 2$. Let \mathbb{OS}_1 be its outer 1-string representation.

Subclaim 1. Any filled zone \mathcal{Z} in \mathbb{OS}_1 contains a k -face.

Proof. We prove that if \mathcal{Z} does not contain a k -face, then we show the existence of a degree one vertex, contradicting the $\delta \geq 2$ restriction.

Suppose a filled zone \mathcal{Z} has no k -face in it. Then the strings supported by \mathcal{Z} induce a forest in OS_1 . Let s be a string supported by \mathcal{Z} . We focus on the component of the forest containing the string s . We claim that s cannot be the only string in this tree. Else both the neighbours of s intersect the bounding strings of \mathcal{Z} , either forming a 5-face (contradicting our assumption if $g = 5$, else contradicting the girth of the graph if $g > 5$), or inducing a cycle of length four (contradicting our girth assumption). Hence there are other strings in the tree. This tree has at least two leaves (degree one vertices). But no two leaves intersect with the strings that intersect the bounding strings of \mathcal{Z} , else a k -face is formed in \mathcal{Z} , contradicting our assumption. Hence there is at least one leaf of this tree that does not intersect with any string intersecting the bounding strings of \mathcal{Z} . The degree of this leaf is one in OS_1 , contradicting our minimum degree assumption. This proves the subclaim. \square

Remark 8 (Branching argument). The above line of argument is used repeatedly in the main proof in the next section. We call it as the *branching argument*. Precisely, if a filled zone is not allowed to have a k -face in it, then we cannot have $\delta \geq 2$, else the forest/tree induced by the strings supported by the zone has its leaves (except one) with degree one in OS_1 , contradicting our minimum degree restriction. Another variant of this argument can be when a filled zone has exactly one k -face, then the other strings supported by the zone induce a forest. At least one leaf of this forest has degree one in OS_1 , again contradicting our minimum degree restriction.

On the other hand, by a *converse branching argument*, we satisfy the $\delta \geq 2$ requirement, forcing the formation of a k -face.

3.8 A Stronger Claim and its Proof

In this section, we prove the following stronger version of [Theorem 6](#).

Claim 2. *Given an outer 1-string graph OS_1 with girth $g \geq 5$ and $\delta \geq 2$, any filled zone \mathcal{Z} in its outer 1-string representation supports the strings of a $(g-4)$ -chain.*

Proof of Claim 2

We proceed by strong induction on the number of vertices of OS_1 . For the base case, the smallest graph with girth $g \geq 5$ and $\delta \geq 2$ is a cycle on g vertices. As seen in Claim 1, the intermediate strings in its outer 1-string representation induce a $(g - 4)$ -chain in each of its filled zones. Now assume that in any outer 1-string graph on less than l vertices with girth $g \geq 5$ and $\delta \geq 2$, every filled zone contains a $(g - 4)$ -chain in the outer 1-string representation.

Let OS_1 be an outer 1-string graph on l vertices with girth $g \geq 5$ and $\delta \geq 2$, and let \mathbb{OS}_1 be its outer 1-string representation. Consider a filled zone \mathcal{Z} in \mathbb{OS}_1 . Such a filled zone \mathcal{Z} exists as OS_1 has a cycle in it (see Claim 1). Let s_t and s_b be the top and bottom defining strings of \mathcal{Z} , respectively. The rest of the proof relies heavily on the following subclaim.

Subclaim 2. *We can safely assume that every string in \mathbb{OS}_1 has an intersection point in $Int(\mathcal{Z})$.*

Proof. Suppose the subclaim does not hold, that is, there is a string s^* that has no intersection point in $Int(\mathcal{Z})$. Then we shall show that \mathcal{Z} supports the strings of a $(g - 4)$ -chain, that is, $Int(\mathcal{Z})$ contains a $(g - 4)$ -chain (except the fixed ends of these strings). Recall that by Subclaim 1, there is a k -face in \mathcal{Z} .

Case 1. If both the defining strings of \mathcal{Z} , that is s_t and s_b , are the bounding strings of a k -face enclosed in \mathcal{Z} , then remove all the strings, except s_t and s_b , that do not have an intersection point in $Int(\mathcal{Z})$. The graph induced by the remaining strings is an outer 1-string graph on a smaller number of vertices with girth $g \geq 5$ and $\delta \geq 2$.

Indeed, at least one string (for example s^*) is removed. The girth of a graph does not decrease by deleting vertices. And $\delta \geq 2$ due to the following reasons. Both the strings s_t and s_b have at least two intersection points, as they are the bounding strings of the k -face. Every string supported by \mathcal{Z} has at least two intersection points. Else such a string has one intersection point in \mathbb{OS}_1 , as the removed strings do not intersect it. This contradicts $\delta \geq 2$ for OS_1 . Rest of the strings have an intersection point in $Int(\mathcal{Z})$ as well as intersect s_t or s_b .

Thus, by our induction hypothesis, there is a $(g - 4)$ -chain in $Int(\mathcal{Z})$. The removed strings do not have any intersection point in $Int(\mathcal{Z})$, and thus they

do not intersect this chain. Hence this $(g - 4)$ -chain still exists in $Int(\mathcal{Z})$ in \mathbb{OS}_1 .

Case 2. Else, both s_t and s_b are not the bounding strings of the same k -face in \mathcal{Z} . Let \mathcal{F} be a k -face in \mathcal{Z} (existence of \mathcal{F} is implied by [Subclaim 4](#)) with induced sub-representation \mathbb{F} . Let \mathcal{Z}' be a filled zone in \mathbb{F} with top and bottom defining strings s'_t and s'_b , respectively (existence of \mathcal{Z}' is implied by [Claim 3](#)). Depending on the fixed ends of s_t, s_b, s'_t and s'_b we will have a few cases. The only restrictions that always hold are the following: the fixed end of s_t is above the fixed end of s_b , and the fixed end of s'_t is above the fixed end of s'_b . Let $(s_i s_j s_k s_l)$ denote that the fixed ends of s_i, s_j, s_k and s_l are ordered from top to bottom.

First let us consider the cases where all the four cases are distinct. The possibilities $(s_t s_b s'_t s'_b)$, $(s'_t s'_b s_t s_b)$, and $(s'_t s_t s_b s'_b)$ induce a cycle of length three or four on these four strings, contradicting our girth assumptions. So the remaining possibilities are $(s_t s'_t s_b s'_b)$, $(s'_t s_t s'_b s_b)$, and $(s_t s'_t s_b s'_b)$.

Next, we consider the cases where all the four strings are not distinct. When $s_t = s'_t$, we have the cases $(s_t = s'_t s'_b s_b)$ and $(s_t = s'_t s_b s'_b)$. When $s_b = s'_b$, we have cases $(s_t s'_t s_b = s'_b)$ and $(s'_t s_t s_b = s'_b)$. The other remaining cases are $(s_t s_b = s'_t s'_b)$ and $(s'_t s'_b = s_t s_b)$.

Many of the cases are of similar nature: $(s'_t s_t s'_b s_b)$ is similar to $(s_t s'_t s_b s'_b)$; $(s_t = s'_t s'_b s_b)$ is similar to $(s_t s'_t s_b = s'_b)$; $(s_t = s'_t s_b s'_b)$ is similar to $(s'_t s_t s_b = s'_b)$; and $(s_t s_b = s'_t s'_b)$ is similar to $(s'_t s'_b = s_t s_b)$. So we shall finally study the following cases: $(s_t s'_t s'_b s_b)$, $(s'_t s_t s'_b s_b)$, $(s_t = s'_t s'_b s_b)$, $(s_t = s'_t s_b s'_b)$, and $(s_t s_b = s'_t s'_b)$. In the second case, we will have two possibilities depending on which of s_t or s_b does s'_t intersect.

We summarize the cases depending on the difficulty level: $(s_t s'_t s'_b s_b)$, $(s_t = s'_t s'_b s_b)$, $(s_t = s'_t s_b s'_b)$, $(s_t s_b = s'_t s'_b)$, and $(s'_t s_t s'_b s_b)$. The last case will have two possibilities depending on which of s_t or s_b does s'_t intersect.

Hence we have to handle the following cases.

- (i) the fixed end of s'_t is below the fixed end of s_t and the fixed end of s'_b is above the fixed end of s_b (see [Figure 3.5a](#)), or
- (ii) without loss of generality, $s'_t = s_t$ and the fixed end of s'_b is above the fixed end of s_b (see [Figure 3.5b](#), [Figure 3.5c](#)), or

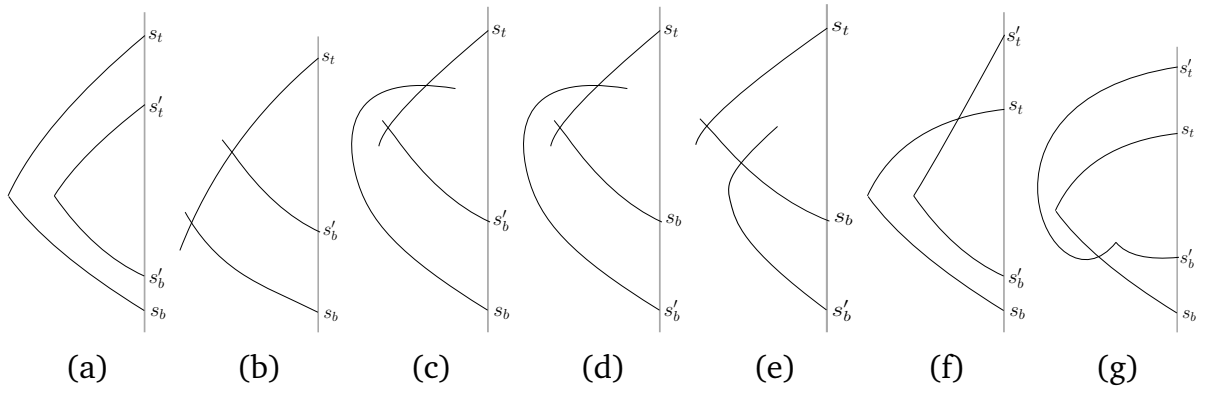

Figure 3.5: Possible configurations for Case 2.

- (iii) without loss of generality, $s'_t = s_t$ and the fixed end of s'_b is below the fixed end of s_b (see Figure 3.5d), or
- (iv) without loss of generality $s_b = s'_t$ (see Figure 3.5e), or
- (v) without loss of generality, the fixed end of s'_t is above the fixed end of s_t , and the fixed end of s'_b is above the fixed end of s_b , and s'_t intersects s_t (see Figure 3.5f), or
- (vi) without loss of generality, the fixed end of s'_t is above the fixed end of s_t , and the fixed end of s'_b is above the fixed end of s_b , and s'_t intersects s_b (see Figure 3.5g).

(i) In the first subcase (see Figure 3.5a), repeat the above argument of Case 1 for zone \mathcal{Z}' instead of \mathcal{Z} . The induction hypothesis holds as (at least s^* and) at least one of the strings s_t and s_b are removed (both of s_t and s_b cannot have an intersection point in $Int(\mathcal{Z}')$ as then each of them intersect either of s'_t and s'_b , inducing a cycle of length three or four, thereby contradicting our girth assumption). This holds irrespective of the number of intersection points in the left envelope of \mathbb{F} . Thus, by our induction hypothesis, there is a $(g - 4)$ -chain in $Int(\mathcal{Z}')$, which still remains a $(g - 4)$ -chain in $Int(\mathcal{Z}')$ in \mathbb{OS}_1 . This $(g - 4)$ -chain is also in $Int(\mathcal{Z})$.

(ii) For the second subcase (see Figure 3.5b, Figure 3.5c), repeat the above argument of Case 1 for zone \mathcal{Z}' instead of \mathcal{Z} . The induction hypothesis holds as at least s^* is removed. Hence there is a $(g - 4)$ -chain in $Int(\mathcal{Z}')$. This holds irrespective of the number of intersection points in the left envelope of \mathbb{F} . The

$(g - 4)$ -chain in $Int(\mathcal{Z}')$ still remains a $(g - 4)$ -chain in $Int(\mathcal{Z}')$ in \mathbb{OS}_1 . This $(g - 4)$ -chain is also in $Int(\mathcal{Z})$.

(iii) In the third subcase (see [Figure 3.5d](#)), note that since both of s_t and s_b are not the bounding strings of a k -face in \mathcal{Z} , every curve (in \mathcal{Z}) from a point in s_t to a point in s_b goes via the intersection point $s_t \cap s_b$.

Repeat the above argument of Case 1 for zone \mathcal{Z} . It may happen that the degree of s_b is one (only when s_b intersects just s_t and s^*). In such a case delete s_b . The resulting representation is an outer 1-string representation on smaller number of vertices with $g \geq 5$ and $\delta \geq 2$. By our induction hypothesis there is a $(g - 4)$ -chain in each filled zone.

We claim that there is one such $(g - 4)$ -chain in the region that is $Int(\mathcal{Z})$ in the initial outer 1-string representation before deleting the strings. Clearly, if s_b is not removed, then the claim holds by our induction hypothesis. Else consider the $(g - 4)$ -chain in \mathbb{F} . It lies in the mentioned region (original $Int(\mathcal{Z})$); otherwise, it would have intersected s_b . If any other string intersects this $(g - 4)$ -chain, then by a converse branching argument we will have a k -face and filled zone in $Int(\mathcal{Z})$, thereby reducing this case to Case 2(i) or Case 2(ii). Hence there is one such $(g - 4)$ -chain in the region that is $Int(\mathcal{Z})$ in the initial outer 1-string representation before deleting the strings.

None of the removed strings intersect the so obtained $(g - 4)$ -chain. So this $(g - 4)$ -chain is also in $Int(\mathcal{Z})$ in \mathbb{OS}_1 .

(iv) The fourth subcase (see [Figure 3.5e](#)) is similar to the third subcase. Note that since both of s_t and s_b are not the bounding strings of a k -face in \mathcal{Z} , every curve (in \mathcal{Z}) from a point in s_t to a point in s_b goes via some intersection point of the type $s_t \cap s_b$. Otherwise, there exists a k -face with s_t and s_b as bounding strings.

Repeat the above argument of Case 1 for zone \mathcal{Z} . If the degree of s_t remains at least two, then the resulting representation is an outerstring representation on smaller number of vertices with $g \geq 5$ and $\delta \geq 2$. By our induction hypothesis there is a $(g - 4)$ -chain in each filled zone. This $(g - 4)$ -chain is in $Int(\mathcal{Z})$.

If the degree of s_t becomes one (after repeating the above argument of Case 1 for zone \mathcal{Z}), then delete s_t . The degree of $s_b (= s'_t)$ is at least two, as it is a bounding string of \mathcal{F} and s'_b is not deleted (as it has an intersection point

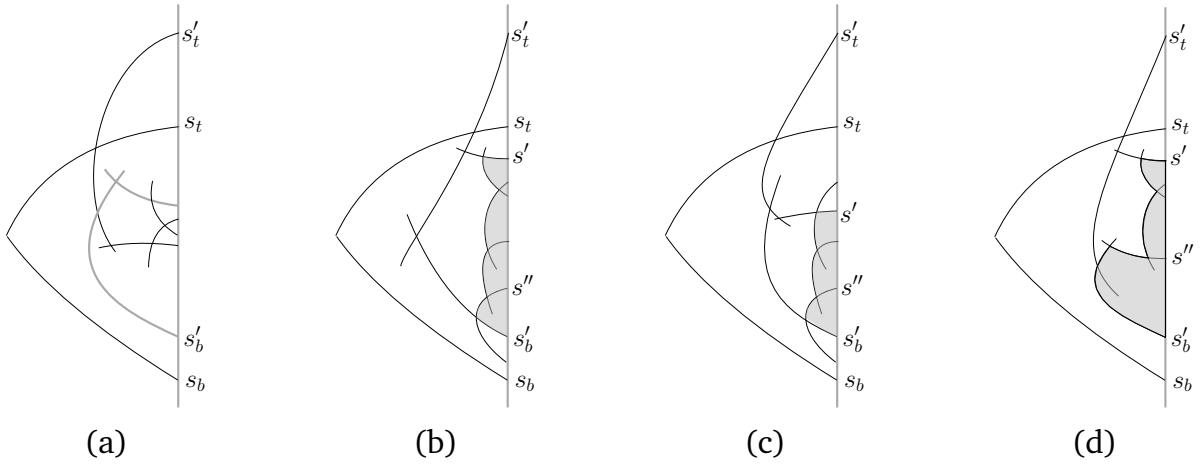

Figure 3.6: Possibilities of Case 2(v)

in $Int(\mathcal{Z})$). Hence, the resulting representation is an outerstring representation on smaller number of vertices with $g \geq 5$ and $\delta \geq 2$. By our induction hypothesis there is a $(g - 4)$ -chain in each filled zone.

By following the corresponding part in the third subcase (or otherwise) we can show that there is one such $(g - 4)$ -chain in the region that is $Int(\mathcal{Z})$ in the initial outerstring representation before deleting the strings.

None of the removed strings intersect the so obtained $(g - 4)$ -chain. So this $(g - 4)$ -chain is also in $Int(\mathcal{Z})$ in \mathbb{OS}_1 .

(v) In the fifth subcase (see [Figure 3.5f](#)), we use the following property. Since both the strings s_t and s_b are not the bounding strings of the same k -face in \mathcal{Z} , so any curve (formed by parts of strings in \mathbb{OS}_1) from a point on s_b to s'_b goes via s_t . Otherwise, there exists a k -face with s_t and s_b as bounding strings.

Hence any string intersecting s'_b does not intersect s_b . Furthermore, any string intersecting s'_b also does not intersect s_t , else a cycle of length four is induced, contradicting our girth assumption. Now we further subdivide this subcase into three parts depending on the number of intersection points in the left envelope of \mathbb{F} . Furthermore, among all possibilities of \mathcal{F} , we choose an \mathcal{F} such that the fixed end of s'_b is the lowest.

(a) Consider the case where the left envelope of \mathbb{F} has just one intersection point. Then it has three filled zones (see [Remark 6](#)) containing the k -face \mathcal{F} . One of these three filled zones (highlighted in [Figure 3.6a](#)) is completely contained in $Int(\mathcal{Z})$. Note that s_t does not intersect the defining

strings of the highlighted filled zone, else it contradicts our girth assumption. This reduces this subcase to Case 2(i). So there is a $(g - 4)$ -chain in $Int(\mathcal{Z})$. See [Figure 3.6a](#).

- (b) Consider the case where the left envelope of \mathbb{F} has three intersection points. Let $s'(\neq s'_b)$ be the other string in \mathbb{F} that intersects s'_t . (Recall that the bounding strings of \mathcal{F} induces a cycle.) Note that the fixed end of s' cannot be above the fixed end of s'_t , else s_t intersects both s' and s'_t inducing a cycle of length three, thereby contradicting our girth assumption. Let $s''(\neq s'_t)$ be the other string in \mathbb{F} that intersects s'_b . The fixed end of s'' can either be in $Int(\mathcal{Z}')$ or outside it.

We claim that s'' and the intermediate strings except the one intersecting s' induce a $(g - 4)$ -chain. Suppose some string intersects any of the intermediate strings mentioned in the above claim, then by a converse branching argument there is a k -face in one of the highlighted regions in [Figure 3.6b](#). So there is a filled zone in \mathcal{Z} containing a k -face.

Note that the bounding strings of this k -face cannot intersect either s_b or s_t (else it either contradicts that s_t and s_b are not the bounding strings of a k -face or it contradicts our girth assumption, respectively). So this subcase eventually reduces to Case 2(i). So the mentioned intermediate strings form a $(g - 5)$ -chain. For the same reason no other string intersects s'' in $Int(\mathcal{Z}')$. Next suppose a string intersects s'' outside \mathcal{Z}' , then by a converse branching argument there is a k -face outside \mathcal{Z}' . This contradicts the choice of \mathcal{F} . As s'' intersects an end of the $(g - 5)$ -chain formed by the mentioned intermediate strings, all these strings combine to induce a $(g - 4)$ -chain, which lies completely in $Int(\mathcal{Z})$. See [Figure 3.6b](#).

- (c) Consider the case where the left envelope of \mathbb{F} has two intersection points. Let $s'(\neq s'_b)$ be the other string in \mathbb{F} that intersects s'_t . Let $s''(\neq s'_t)$ be the other string in \mathbb{F} that intersects s'_b . Irrespective of whether this configuration is as shown in [Figure 3.6c](#) or [Figure 3.6d](#), proceed exactly as in Case 2(iv)(b) to get the $(g - 4)$ -chain that is completely contained in $Int(\mathcal{Z})$. When the configuration is as shown in [Figure 3.6d](#), there is a minor deviation from Case 2(iv)(b) with respect to the contradiction obtained for more than two strings intersecting s'' . Here the part where the choice of \mathcal{F} is contradicted does not arise. Rest all the arguments are the same.

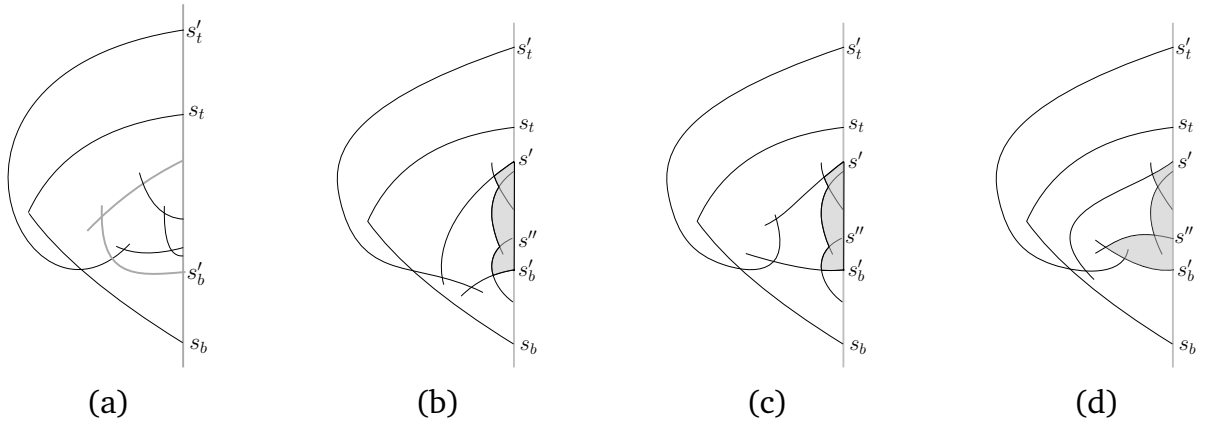

Figure 3.7: Possibilities of Case 2(vi)

(vi) The analysis of the sixth subcase (see [Figure 3.5g](#)) is very similar to the fifth subcase. In the fifth subcase we use the following property. Since both the strings s_t and s_b are not the bounding strings of the same k -face in \mathcal{Z} , so any curve (formed by parts of strings in \mathbb{OS}_1) from a point on s_t to s'_b goes via s_b . Otherwise, there exists a k -face with s_t and s_b as bounding strings.

Now we further subdivide into three parts depending on the number of intersection points in the left envelope of \mathbb{F} . Furthermore, among all possibilities of \mathcal{F} , we choose an \mathcal{F} such that the fixed end of s' is the highest, where $s'(\neq s'_b)$ be the other string in \mathbb{F} that intersects s'_t .

- (a) Consider the case where the left envelope of \mathbb{F} has just one intersection point. Then it has three filled zones (see [Remark 6](#)) containing the k -face \mathcal{F} . One of these three filled zones (highlighted in [Figure 3.7a](#)) is completely contained in $\text{Int}(\mathcal{Z})$. Note that s_b does not intersect the defining strings of the highlighted filled zone, else a cycle of length four is induced, contradicting our girth assumption. This reduces this subcase to Case 2(i). So there is a $(g - 4)$ -chain in $\text{Int}(\mathcal{Z})$. See [Figure 3.7a](#).
- (b) Consider the case where the left envelope of \mathbb{F} has three intersection points. Let $s'(\neq s'_b)$ be the other string in \mathbb{F} that intersects s'_t . (Recall that the bounding strings of \mathcal{F} induces a cycle.) Let $s''(\neq s'_t)$ be the other string in \mathbb{F} that intersects s'_b .

We claim that the intermediate strings induce a $(g - 4)$ -chain. Suppose some string intersects the intermediate string in the highlighted regions in [Figure 3.7b](#), then by a converse branching argument there is a k -face in one of the highlighted region. So there is a filled zone in \mathcal{Z} containing a

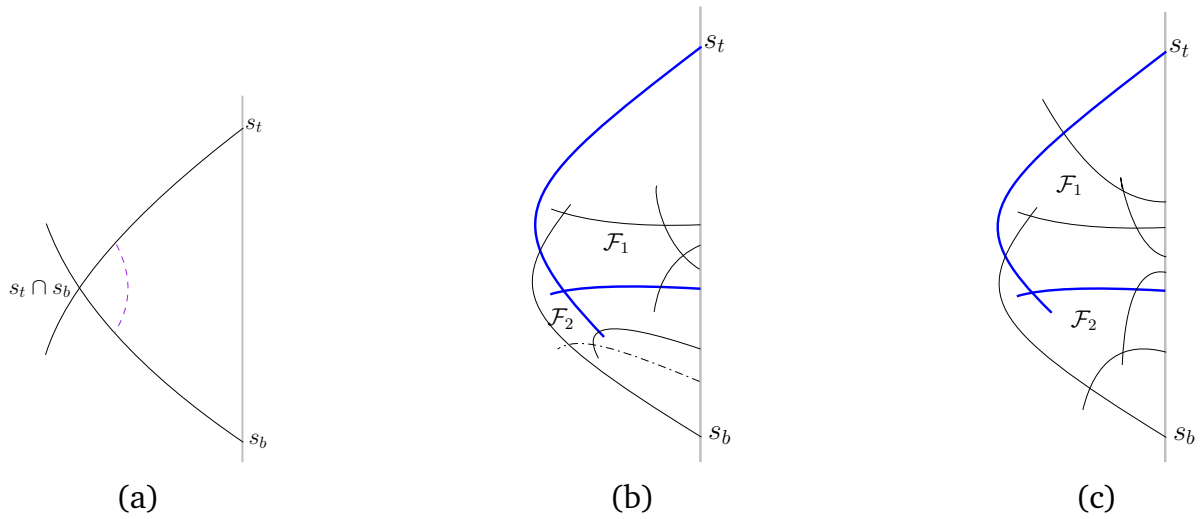

Figure 3.8: An illustration if \mathcal{Z}_1 and \mathcal{Z}_1 have the same defining strings.

k -face. Note that none of the bounding strings of this k -face can intersect either s_t or s_b (else it either contradicts that s_t and s_b are not the bounding strings of a k -face or it contradicts our girth assumption, respectively). So this subcase eventually reduces to Case 2(i).

Next suppose some string intersects the intermediate string (intersecting s') in the region bounded by s_t , s_b , s'_t , s' and the grounding line, then by a converse branching argument there is a k -face in this region. This contradicts the choice of \mathcal{F} . Hence the intermediate strings induce a $(g - 4)$ -chain, which lies completely in $Int(\mathcal{Z})$. See Figure 3.7b.

- (c) Consider the case where the left envelope of \mathbb{F} has two intersection points. Let $s'(\neq s'_b)$ be the other string in \mathbb{F} that intersects s'_t . Let $s''(\neq s'_t)$ be the other string in \mathbb{F} that intersects s'_b . Irrespective of whether this configuration is isomorphic to the figures in Figure 3.7c, Figure 3.7d, proceed exactly as in Case 2(iii)(b) to get the $(g - 4)$ -chain that is completely contained in $Int(\mathcal{Z})$.

Therefore, we can safely assume that every string in \mathbb{OS}_1 has an intersection point in $Int(\mathcal{Z})$. □

We can also safely assume that OS_1 is not isomorphic to the cycle on l vertices. Indeed, we have proved Claim 2 for cycles in Claim 1. Hence there are at least two (induced) cycles in OS_1 . In order to prove Claim 2, next, we prove the following.

Subclaim 3. \mathbb{OS}_1 has at least two filled zones.

Proof. Since there are two induced cycles in OS_1 , there will be two distinct k -faces, say \mathcal{F}_1 and \mathcal{F}_2 , in \mathbb{OS}_1 . Hence there is at least one filled zone in each of \mathbb{F}_1 and \mathbb{F}_2 . Since a filled zone is uniquely determined by its defining strings, we need to show that there exists filled zones \mathcal{Z}_1 in \mathbb{F}_1 , and \mathcal{Z}_2 in \mathbb{F}_2 that do not have the same defining strings.

Suppose \mathcal{Z}_1 and \mathcal{Z}_2 have the same defining strings, say s_t and s_b . This implies $\mathcal{Z}_1 = \mathcal{Z}_2 = \mathcal{Z}$ (say). Both \mathcal{F}_1 and \mathcal{F}_2 have the same intersection point $s_t \cap s_b$ in their boundary as one of its corners. There are two possible configurations depending on how s_b and s_t intersect.

In the first configuration (see [Figure 3.8a](#)) the free ends of s_t and s_b are not inside its zone. Since both \mathcal{F}_1 and \mathcal{F}_2 are in \mathcal{Z} (by [Remark 7](#)), it is not possible that both \mathcal{F}_1 and \mathcal{F}_2 have $s_t \cap s_b$ in their boundary (recall that all intersection points are distinct). Hence the first configuration is not possible.

In the second configuration, the free ends of s_t and s_b are in $Int(\mathcal{Z})$. Suppose, without loss of generality, \mathbb{F}_1 has just one intersection point in its left envelope (see [Figure 3.8b](#)). Then \mathbb{F}_1 has three filled zones (see [Remark 6](#)). \mathcal{F}_2 also contains the intersection point $s_t \cap s_b$. There are two possibilities of where \mathcal{F}_2 lies in \mathcal{Z} with respect to \mathcal{F}_1 . Without loss of generality, assume \mathcal{F}_2 is as shown in [Figure 3.8b](#). Then there is at least one string in \mathbb{F}_2 that has no intersection point in the highlighted filled zone in \mathbb{F}_1 . This contradicts [Subclaim 2](#).

Thus none of \mathbb{F}_1 and \mathbb{F}_2 has just one intersection point in their respective left envelopes. (Then there are exactly two intersection points in their left envelope (see [Figure 3.8c](#).) Then the configuration as shown in the figure is the only possibility (upto isomorphism). Here also there is at least one string in \mathbb{F}_2 that has no intersection point in the highlighted filled zone. This contradicts [Subclaim 2](#). Hence the second configuration is not possible.

Hence there are at least two distinct filled zones. □

Next, using [Subclaim 3](#), we find some possible configurations.

Two possible configurations

Let the two distinct filled zones be \mathcal{Z}_1 in \mathbb{F}_1 , and \mathcal{Z}_2 in \mathbb{F}_2 . Let s_{t_1} and s_{b_1} be the top and bottom defining strings of \mathcal{Z}_1 . Let s_{t_2} and s_{b_2} be the top and bottom defining strings of \mathcal{Z}_2 . Without loss of generality assume that the fixed end of

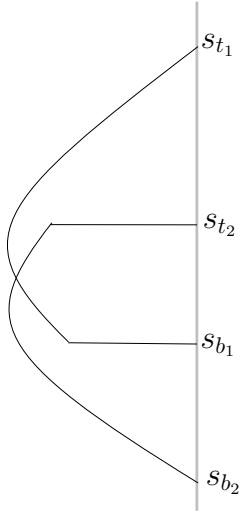

(a) Configuration 1

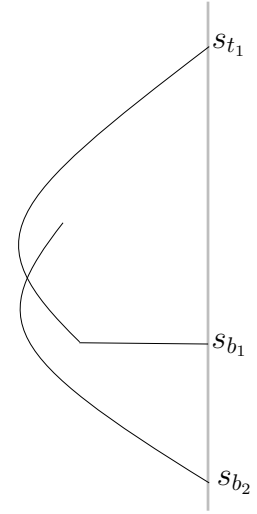

(b) Configuration 2

Figure 3.9: Final two configurations to be checked.

s_{t_1} is above or at the fixed end of s_{t_2} .

First we consider the case where all the strings s_{t_1} , s_{b_1} , s_{t_2} and s_{b_2} are distinct.

If s_{t_1} intersects s_{t_2} , then first we claim that s_{b_1} is enclosed in \mathcal{Z}_2 . Otherwise, to satisfy [Subclaim 2](#), s_{b_1} intersects either of s_{t_2} or s_{b_2} inducing a cycle of length three or four. This contradicts our girth assumption. This also implies that s_{b_2} has no intersection point in $Int(\mathcal{Z}_1)$, as it cannot intersect either of s_{t_1} or s_{b_1} because of our girth assumption. This contradicts [Subclaim 2](#).

If s_{t_1} intersects s_{b_2} , then first we claim that s_{b_1} is enclosed in \mathcal{Z}_2 . Otherwise, to satisfy [Subclaim 2](#), s_{b_1} intersects either of s_{t_2} or s_{b_2} inducing a cycle of length three or four. This contradicts our girth assumption. Hence s_{t_2} is enclosed in \mathcal{Z}_1 . This is a possible configuration (see [Figure 3.9a](#)).

Next, suppose without loss of generality, $s_{t_1} = s_{t_2}$. Also without loss of generality assume that the fixed end of s_{b_2} is lower than the fixed end of s_{b_1} . Then s_{b_1} does not intersect s_{b_2} , else it contradicts our girth assumption. Also s_{b_2} has an intersection point in \mathcal{Z}_1 . So s_{b_2} intersects s_{t_1} and then enters \mathcal{Z}_1 (by [Subclaim 2](#)). Hence this is also a possible configuration (see [Figure 3.9b](#)).

Next, it remains to consider the case when $s_{b_1} = s_{t_2}$. By [Subclaim 2](#), s_{t_1} has an intersection point in $Int(\mathcal{Z}_2)$. Without loss of generality, suppose s_{b_2} crosses $s_{b_1}(=s_{t_2})$ to enter $Int(\mathcal{Z}_1)$ (by [Subclaim 2](#)). Then a cycle of length three is induced by strings s_{t_1} , s_{b_1} and s_{b_2} as s_{t_1} also has an intersection point in $Int(\mathcal{Z}_1)$ (by [Subclaim 2](#)). This contradicts our girth assumption.

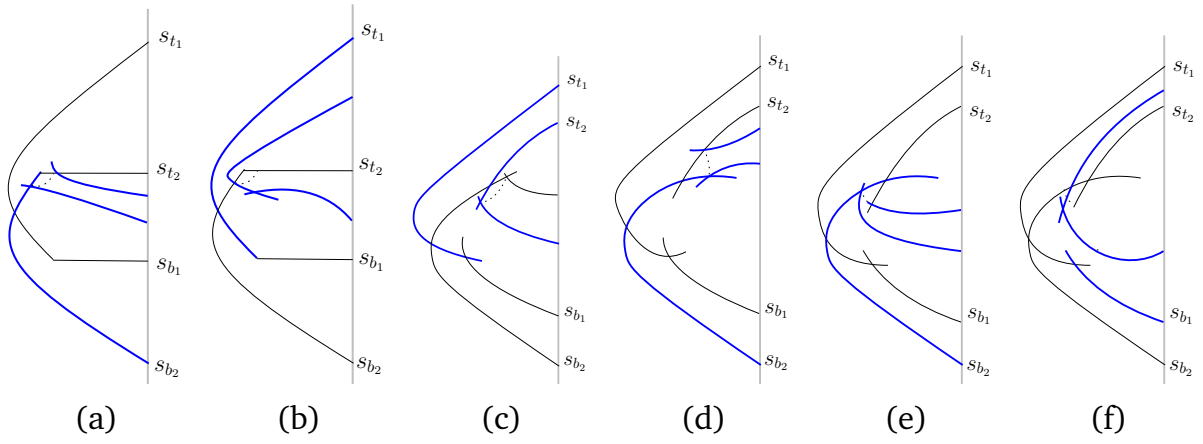

Figure 3.10: Possibilities of the first configuration.

So we have to consider the configurations as shown in [Figure 3.9a](#) and [Figure 3.9b](#).

Configuration 1

First consider the configuration as shown in [Figure 3.9a](#). Recall that faces \mathcal{F}_1 and \mathcal{F}_2 contains intersection points $s_{t_1} \cap s_{b_1}$ and $s_{t_2} \cap s_{b_2}$, respectively, in their boundary. Let $p(s_{b_2})$ be the part of s_{b_2} between the intersection points $s_{t_2} \cap s_{b_2}$ and $s_{t_1} \cap s_{b_2}$, and let $p(s_{b_1})$ be the part of s_{b_1} between the intersection points $s_{t_1} \cap s_{b_1}$ and $s_{t_1} \cap s_{b_2}$. Without loss of generality, assume that there is a bounding string of \mathcal{F}_2 that has a point in $p(s_{b_2})$. The fixed end of this bounding string is between the fixed ends of s_{t_1} and s_{b_1} . If its fixed end is between the fixed ends of s_{t_2} and s_{b_1} , then the zone of this string and s_{b_2} is filled, as it supports s_{b_1} . The other bounding string of \mathcal{F}_2 (other than s_{b_2}) that intersects s_{t_2} does not have any intersection point in this filled zone, else it contradicts our girth assumption (see [Figure 3.10a](#)). This contradicts [Subclaim 2](#). If its fixed end is between the fixed ends of s_{t_1} and s_{t_2} , then the zone of this string and the other bounding string of \mathcal{F}_2 it intersects (other than s_{b_2}) is filled, as it supports s_{t_2} . Note that the string s_{t_1} has no intersection point in this filled zone, else it contradicts our girth assumption (see [Figure 3.10b](#)). This contradicts [Subclaim 2](#).

Similarly, there are no bounding strings of \mathcal{F}_1 that has a point in $p(s_{b_1})$. Hence none of \mathcal{F}_1 and \mathcal{F}_2 have three intersection points in its left envelope. Suppose \mathcal{F}_2 has just one intersection point in its left envelope. Then the zone of the strings s_{t_2} and the other bounding string of \mathcal{F}_2 intersecting s_{t_2} (other

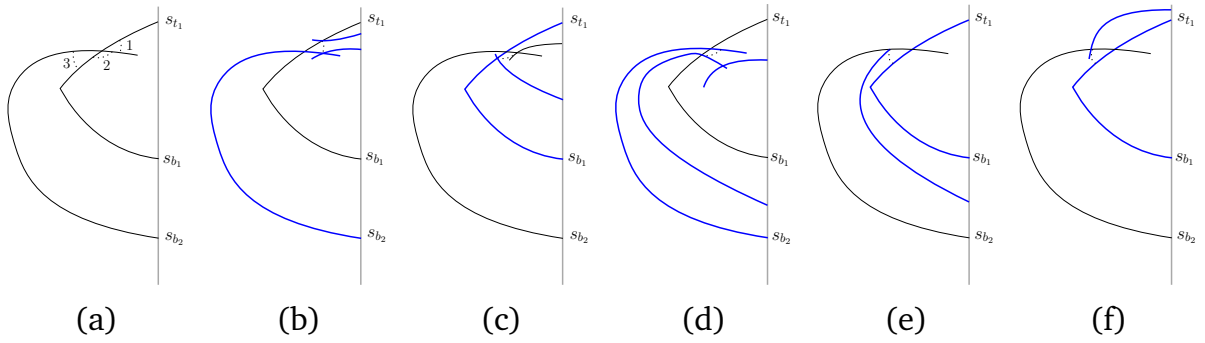

Figure 3.11: Possibilities of the second configuration.

than s_{b_2}) is filled as it supports the other bounding string of \mathcal{F}_2 intersecting s_{b_2} . Note that the string s_{t_1} has no intersection point in this filled zone (see [Figure 3.10c](#)). This contradicts [Subclaim 2](#). Next, suppose \mathcal{F}_2 has two intersection points in its left envelope. There are three possibilities as shown in [Figure 3.10d](#), [Figure 3.10e](#) and [Figure 3.10f](#). In first two possibilities ([Figure 3.10d](#) and [Figure 3.10e](#)), the zone formed by s_{b_2} and the other bounding string of \mathcal{F}_2 (other than s_{t_2}) intersecting s_{b_2} is filled as it supports s_{b_1} . Note that the bounding string intersecting s_{t_2} other than s_{b_2} has no intersection point in this filled zone (see [Figure 3.10d](#) and [Figure 3.10e](#)). In the third possibility ([Figure 3.10f](#)), the zone formed by the other string intersecting s_{b_2} (other than s_{t_2}) and the other bounding string of \mathcal{F}_2 intersecting it is filled as it supports s_{t_2} . Note that the string s_{b_1} has no intersection point in this filled zone (see [Figure 3.10f](#)). This contradicts [Subclaim 2](#).

Hence the configuration shown in [Figure 3.9a](#) is not possible.

Configuration 2

Next we consider the configuration as shown in [Figure 3.9b](#). Recall that faces \mathcal{F}_1 and \mathcal{F}_2 contains intersection points $s_{t_1} \cap s_{b_1}$ and $s_{t_2} \cap s_{b_2}$, respectively, in their boundary. Depending on the relative location of \mathcal{F}_2 with respect to the strings s_{t_1} and s_{b_2} , we will have three cases as shown in [Figure 3.11a](#).

For the Case 1, the zone formed by the strings s_{b_2} and the other bounding string of \mathcal{F}_2 intersecting s_{b_2} (other than s_{t_1}) is filled as it supports s_{b_1} . Note that the bounding string of \mathcal{F}_2 intersecting s_{t_1} (other than s_{b_2}) has no intersection point in this filled zone (see [Figure 3.11b](#)). This contradicts [Subclaim 2](#).

For the Case 2, there is a bounding string of \mathcal{F}_2 has a point in s_{t_1} between

$s_{t_1} \cap s_{b_1}$ and $s_{t_1} \cap s_{b_2}$. Its fixed end is either between the fixed ends of s_{t_1} and s_{b_1} , or between the fixed ends of s_{b_1} and s_{b_2} . For the former, the zone by this string and s_{t_1} is filled as it supports at least one bounding string of \mathcal{F}_2 (the one intersecting s_{b_2} , other than s_{t_1}). Note that the string s_{b_1} has no intersection point in the interior of this filled zone (see [Figure 3.11c](#)). This contradicts [Subclaim 2](#). For the latter, the zone by this string and the bounding string of \mathcal{F}_2 it intersects other than s_{t_1} is filled as it supports s_{b_1} . Note that the string s_{b_2} has no intersection point in this filled zone (see [Figure 3.11d](#)). This contradicts [Subclaim 2](#).

For the Case 3, consider the filled zone formed by the strings s_{t_1} and s_{b_1} . It supports the intermediate strings of \mathbb{F}_1 . The bounding string of \mathcal{F}_2 (other than s_{t_1}), that intersects s_{b_2} has no intersection point in this filled zone (see [Figure 3.11e](#) and [Figure 3.11f](#)). This contradicts [Subclaim 2](#).

Hence the configuration shown in [Figure 3.9b](#) is also not possible.

So both the configurations as shown in [Figure 3.9a](#) and [Figure 3.9b](#) are not possible. This concludes the proof of [Claim 2](#), and hence of [Theorem 6](#). \square

This completes the part of this chapter on outer 1-string graphs.

Part: OUTERSTRING GRAPHS

In this part, we can extend the results on outer 1-string graphs to outerstring graphs. Here also we use the same inductive framework we used in the outer 1-string part. We begin by restating [Theorem 7](#).

Theorem 7. *Outerstring graphs with girth five are 2-degenerate.*

Using a standard greedy coloring scheme, [Theorem 7](#) implies that outerstring graphs with girth five are 3-colorable. Since odd cycles are also outerstring graphs, there are outerstring graphs with girth five that have chromatic number 3. Hence we have the [Corollary 3](#), restated here.

Corollary 3. $\chi_g(\text{OUTERSTRING}, 5) = 3$.

As earlier, [Theorem 7](#) also generalizes a result of Ageev [[Age99](#)]. Below we strengthen [Theorem 5](#) to generalize a result of Esperet and Ochem [[EO09](#)] on circle graphs, who generalized the above result of Ageev.

Theorem 8. *Outerstring graphs with girth $g \geq 5$ and minimum degree $\delta \geq 2$ contains a chain of $(g - 4)$ vertices of degree two.*

We shall prove [Theorem 8](#) only, as the other two results are its corollaries. Also, it suffices to consider only connected outer 1-string graphs.

The proof of [Theorem 8](#) is very similar to that of [Theorem 6](#) for outer 1-string graphs, with many trivial differences (for example, types of intersection points instead of intersection points) and a few non-trivial ones. One way that seems easy would be to mention the differences at the corresponding part of the proof for outerstring graphs. However, we felt that alternating between proofs of outer 1-string graphs and outerstring graphs would be confusing for the reader. Hence we have rewritten the proof all over once again, highlighting the places where the proofs are different. This would enable the reader to skim through the rest of the proof and concentrate on the newer parts. The differences in arguments are summarized in the beginning of each section.

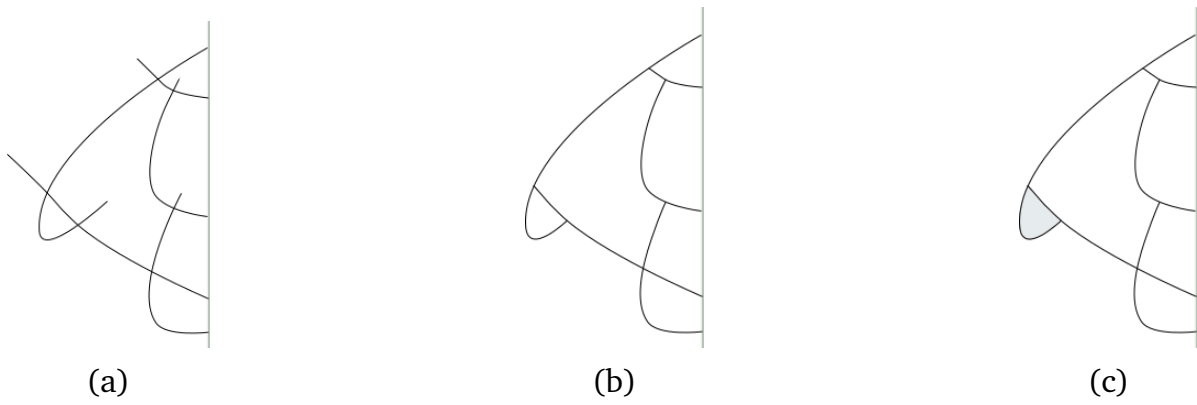

Figure 3.12: (a,b) Outerstring representation without or with our assumption of free end, and (c) a 2-face (shaded region).

3.9 Tools, Definitions and Notations

We use the same tools of topological graph theory as used in outer 1-string graphs. Hence we directly move on to definitions. Here we just mention the new ones.

3.9.1 Basic Definitions

Recall that an outerstring graph is the intersection graph of curves that are contained in a halfplane with one endpoint in the boundary of the halfplane. This boundary is called the *grounding line* of the representation. We assume the grounding line in the outerstring representation to be the Y-axis and the strings lie in the halfplane $x \leq 0$.

For an outerstring graph OS , we denote its outerstring representation as \mathbb{OS} (see Figure 3.12a for an outerstring representation of the cycle C_5). By a result of Biedl, Biniáz and Derka [BBD18], we choose \mathbb{OS} such that it a finite number of intersection points.

As any two strings, say s_i and s_j , might intersect multiple times in \mathbb{OS} , we say all such intersection points are *type (s_i, s_j) intersection points*.

3.9.2 Specific Definitions

We shall now start defining some specific terms that we need in this part: *left envelope*, *zone*, *k-face*, and *extended face*. The first two are the same as outer 1-string graphs. The minor differences can be concluded from the figures:

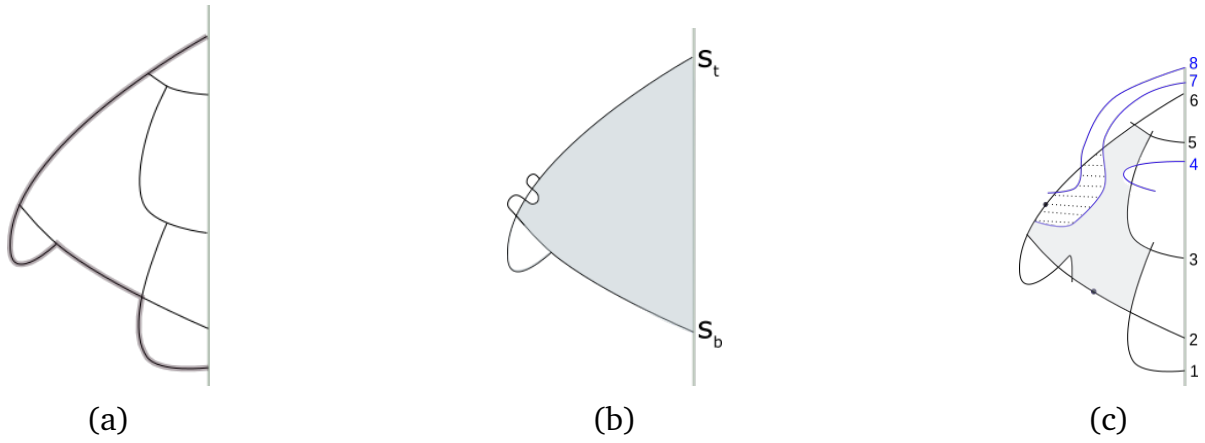

Figure 3.13: (a) Left envelope, (b) Zone of s_t and s_b , and (c) The shaded region is a 5-face, with bounding strings drawn in black. The dotted region is not a k -face.

Figure 3.13a for left envelope and Figure 3.13b for zone. Here we only define the last two: k -face and extended face — that have substantial changes.

k -Face.

Consider an outersting graph OS with girth $g \geq 5$. We are interested in those faces in \mathbb{OS} that contribute to a cycle in OS (not all faces in \mathbb{OS} contribute to a cycle in OS , for example, the 2-faces and the dotted face in Figure 3.13c). We call such faces as k -faces and they can be found using the following algorithm.

Algorithm: Consider a face \mathcal{F} in \mathbb{OS} . Form the cyclic sequence of strings encountered while traversing the boundary of \mathcal{F} with the following restriction. Ignore the strings that contribute just a point in the boundary of \mathcal{F} ; they do not contribute to the cycle in \mathbb{OS} that is formed due to \mathcal{F} (they might contribute to a cycle in OS due to some other face). Iteratively, perform the following operation in the sequence whenever possible: replace instances of $s_i s_j s_i$ by s_i .

This algorithm halts as the number of intersection points in the \mathbb{OS} we consider is finite. This algorithm cannot output just one string, else that string is self-intersecting; contradicting our assumption. If the algorithm outputs just two strings we ignore the face. Else, we call \mathcal{F} as a k -face, where there are k distinct strings in the output. See Figure 3.13c for an example of a k -face. Soon we shall prove (see proof of Observation 10) that all the strings in the output are distinct. Next, we claim that $k \geq g$. Suppose the final output of the algorithm is $s_{i_1} s_{i_2} \dots s_{i_k}$. Clearly, $k > 2$. The output $s_{i_1} s_{i_2} \dots s_{i_k}$ implies that

s_{i_r} intersects $s_{i_{(r \bmod k)+1}}$. So there is a closed curve using these $k > 2$ strings. This implies $k \geq g$, else it contradicts the girth requirement.

The k strings in the output of the algorithm are called the *bounding strings* of the k -face. In contrast, for the other strings encountered while traversing a face \mathcal{F} in a cyclic manner, including the ones that share just one intersection point, we say that they *share* the boundary of \mathcal{F} .

The following examples illustrates the algorithm. In the shaded face in [Figure 3.13c](#), the cyclic sequence formed is $s_2s_6s_2s_6s_7s_6s_5s_3s_4s_3s_1$ and the algorithm returns the sequence $s_2s_6s_5s_3s_1$. Hence it is a k -face ($k = 5$). Whereas, in the dotted face, the cyclic sequence formed is $s_6s_8s_6s_7$ and the algorithm runs as $s_6s_8s_6s_7 \rightarrow s_6s_7$. Hence we ignore it.

Next, we show that the cycle contributed by the k -face \mathcal{F} is an induced cycle in OS . This is exactly as the corresponding observation for outer 1-string graphs.

Observation 10. *The vertices corresponding to the bounding strings of a k -face \mathcal{F} in OS of an outerstring graph OS (with girth $g \geq 5$) form an induced cycle in OS .*

Outline of the Proof. We have to prove two parts. First, we have to show that all the strings in the cyclic sequence are distinct. Second, we have to show that only the consecutive strings in the cyclic sequence intersect. This proves that the corresponding vertices of these strings form an induced cycle in OS . The first condition says that there is no cut-vertex and the second condition says that there is no chord in the graph induced by the vertices corresponding to the bounding strings of a k -face.

First, we show that all the strings in the cyclic sequence are distinct. For sake of contradiction, suppose there exists a string s_i that gets repeated, that is, the sequence is $s_1 \dots s_i s_{i_1} s_{i_2} \dots s_i s_i \dots$ ($i = 1$ is also possible). Recall that adjacent strings in the sequence intersect. So there is a Jordan curve \mathcal{C}_1 formed by parts of strings with the same ordering in the above sequence. To maintain a girth $g \geq 5$ there are at least three strings on each side of the cyclic sequence between the two occurrences of s_i .

Depending on the string s_i we either (1) consider the Jordan curve \mathcal{C}_2 got by tracing s_i instead of $s_{i_1} s_{i_2} \dots$ in \mathcal{C}_1 (that is, \mathcal{C}_2 is formed by strings $s_1 \dots s_i \dots s_1$) such that the inside region of \mathcal{C}_2 contains the inside region of

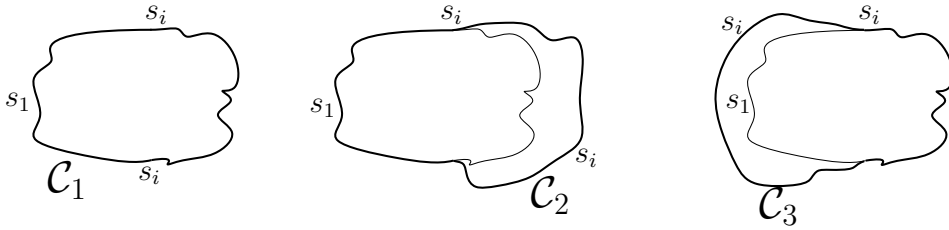

Figure 3.14: Illustration of proof of [Observation 10](#).

\mathcal{C}_1 , or (2) consider the Jordan curve \mathcal{C}_3 got by tracing s_i and $s_{i_1}s_{i_2}\dots s_{i_l}$ in \mathcal{C}_1 (that is, \mathcal{C}_3 is formed by strings $s_i s_{i_1} s_{i_2} \dots s_{i_l} s_i$) such that the inside region of \mathcal{C}_3 contains the inside region of \mathcal{C}_1 . Observe that these two cases are exhaustive. (See [Figure 3.14](#).)

In the first case, there exists an intersection point $x_{1,2}$ of strings s_{i_1} and s_{i_2} on \mathcal{C}_1 that lies in the inside region of \mathcal{C}_2 . Thus, the part of s_{i_2} from its fixed end to $x_{1,2}$ intersects \mathcal{C}_2 . Also s_{i_2} cannot intersect \mathcal{C}_2 at some string other than s_i , else \mathcal{F} cannot be a face. Then s_i, s_{i_1} and s_{i_2} induces a cycle of length three, contradicting our girth assumption.

In the second case, there exists an intersection point $x_{i-2,i-1}$ of the strings s_{i-1} and s_{i-2} on \mathcal{C}_1 that lies in the inside region of \mathcal{C}_3 . So the part of s_{i-2} from its fixed end to $x_{i-2,i-1}$ intersects \mathcal{C}_3 . Also s_{i-2} cannot intersect \mathcal{C}_3 at some string other than s_i , else \mathcal{F} cannot be a face. Then s_i, s_{i-1} and s_{i-2} induces a cycle of length three, contradicting our girth assumption. (By indices $i-2$ and $i-1$, we mean the indices of the strings before s_i in the cyclic sequence.)

Hence all the bounding strings occur exactly once in the sequence. It remains to show that only the consecutive strings in the cyclic sequence intersect.

Suppose the sequence is $s_1 \dots s_i, s_{i+1} \dots s_j \dots$ with s_i intersecting s_j . To maintain a girth $g \geq 5$ there are at least three strings on each side of the cyclic sequence between s_i and s_j . Then, as above, there will be two cases where either (1) s_{i+2} will intersect either s_i or s_j inducing a cycle of length three or four by the strings s_i, s_{i+1} and s_{i+2} , or s_i, s_{i+1}, s_{i+2} and s_j , respectively, or (2) s_{i-2} will intersect either s_i or s_j inducing a cycle of length three or four by the strings s_i, s_{i-1} and s_{i-2} , or s_i, s_{i-1}, s_{i-2} and s_j , respectively. These contradicts our girth assumption. Hence only the consecutive strings in the cyclic sequence intersect.

Therefore, the vertices corresponding to the bounding strings of \mathcal{F} form

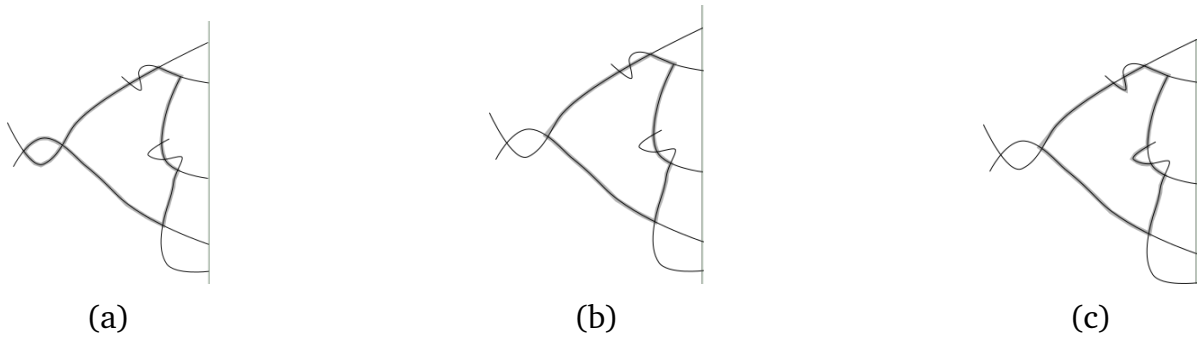

Figure 3.15: (a) non-example that violates conditions 1 and 2 (b) non-example that violates condition 2, and (c) example of an extended face

an induced cycle in OS . □

Extended Face

However, in the other direction, for an induced cycle in an outerstring graph OS with girth five, its induced representation in \mathbb{OS} might not be a face but a collection of faces. We are interested in such a special collection of faces, which we define next.

Given an induced cycle C on k (≥ 5) vertices in OS , there is at least one closed curve in \mathbb{OS} composed of the k strings corresponding to the vertices of C . Let \mathcal{C} denote such a closed curve satisfying the following two conditions.

1. \mathcal{C} is a minimal closed curve in the sense that there is no part of \mathcal{C} that is a closed curve composed of the k strings. (this makes \mathcal{C} a Jordan curve: see [Observation 11](#).)
2. Among all Jordan curves satisfying condition (1), choose \mathcal{C} such that its inside region has the minimum area.

We say the closed inside region of \mathcal{C} is the *extended face* of C . See [Figure 3.15a](#), [Figure 3.15b](#), [Figure 3.15c](#) for non-examples and an example.

To complete the definition, it remains to prove the following observation.

Observation 11. *Let \mathcal{C} be a minimal closed curve composed of $k \geq 5$ strings corresponding to the k vertices of an induced cycle C in OS . Then \mathcal{C} is a Jordan curve.*

Proof. Suppose \mathcal{C} is self-intersecting; then it can be partitioned into Jordan curves⁶ $\mathcal{C}_1, \mathcal{C}_2, \dots$. Let the boundary of \mathcal{C}_i be composed of m_i strings. If $m_i = k$, then it contradicts the minimality of \mathcal{C} . If $3 \leq m_i < k$, then it induces a cycle on less than k vertices in C , contradicting the fact that C is an induced cycle on k vertices. So each of \mathcal{C}_i is composed of exactly two strings each. If \mathcal{C}_i and \mathcal{C}_j are two Jordan curves that have a common point, then as the strings cross at the intersection point, both \mathcal{C}_i and \mathcal{C}_j are composed of the same two strings. Inductively this implies that all \mathcal{C}_i are composed of the same two strings, as $\mathcal{C}_1, \mathcal{C}_2, \dots$ are partitions of a closed curve \mathcal{C} . This is a contradiction. So \mathcal{C} is a Jordan curve on k strings. \square

This completes our definitions. We conclude this section by recalling our assumptions: (1) graphs are simple, finite and connected, (2) strings are simple, (3) the free ends of strings are intersection points, (4) strings cross at the intersection points (except for the free ends), (5) all the intersection points and the fixed ends of the strings are distinct, and (6) there are finite number of intersection points in the considered representation. The last assumption is due to Biedl, Biniaz and Derka [BBD18] and we can safely assume the rest in the context of outerstring graphs and representations.

We skip the outline of the proof, as it is similar to that of outer 1-string graphs and directly move to study representations of cycles.

3.10 Outerstring Representation of Cycles

Compared to the corresponding section in outer 1-string graphs, there is minimal change in this part. Instances of *intersection points* are replaced by *types of intersection points*. A noticeable change is the contradiction obtained in the outer 1-string part of the following nature: ‘This induces a cycle of length less than n ’. Here we have to show that the length of the cycle induced is not only less than n but also at least 3. This is due to the presence of 2-faces. Rest all of the arguments are the same as outer 1-string graphs.

Here we study the structure of outerstring representation \mathcal{C} , of a cycle C on $n \geq 5$ vertices. Let the vertex set of C be $\{v_0, v_1, \dots, v_{n-1}\}$, and let s_i denote the string in \mathcal{C} that represents v_i . Without loss of generality, assume that, for

⁶This is equivalent to partitioning the edge set of an Eulerian graph into edge disjoint cycles.

$i < j$ the fixed point of s_i lies below the fixed point of s_j . The edge set of C depends on how the strings in $\{s_i : 0 \leq i \leq n - 1\}$ intersect. Since degree of each v_i is two, the string s_i in \mathbb{C} contains two types of intersection points, that is, if v_i is adjacent to v_j and v_k in C , then s_i has two types of intersection points (s_i, s_j) and (s_i, s_k) . Also, there are exactly n types of intersection points in \mathbb{C} .

Consider the extended face of C , and let \mathcal{C} be its boundary. We begin with the following observation. Recall that for a closed region \mathcal{R} , its inside region (got after removing its boundary) is denoted by $Int(\mathcal{R})$.

Observation 12. *If the outerstring representation \mathbb{C} of cycle C has a filled zone \mathcal{Z} with defining strings s_t and s_b , then every other string s in the representation has an intersection point in $Int(\mathcal{Z})$.*

Proof. The boundary \mathcal{C} of the extended face of cycle C is a Jordan curve on n strings and contains n types of intersection points. As \mathcal{Z} is a filled zone, it supports a string, say s_j , that is $s_j \cap \mathcal{Z} = s_j$, and s_j does not intersect s_t and s_b .

To the contrary, suppose string s_i has no intersection point in $Int(\mathcal{Z})$. Since C is a cycle, s_i has two types of intersection points in it. First, we claim that all the intersection points on s_i of at least one type lies outside \mathcal{Z} . Suppose both the types of intersection points in s_i are on the defining strings of \mathcal{Z} (particularly, on the boundary of \mathcal{Z}), that is, there are intersection points between strings s_i and s_t , and between strings s_i and s_b . Then s_i, s_t and s_b induce a cycle of length three, contradicting $n \geq 5$. Thus all the intersection points on s_i of at least one type lie outside \mathcal{Z} .

Choose such an intersection point $x_i \in s_i \cap \mathcal{C}$ that lies outside \mathcal{Z} . Also choose an intersection point $x_j \in s_j \cap \mathcal{C}$, which lies in $Int(\mathcal{Z})$. Both x_i and x_j exist as \mathcal{C} contains all the n types of intersection points. The boundary $\partial\mathcal{Z}$ of \mathcal{Z} is a Jordan curve, with x_i in the outside region of $\partial\mathcal{Z}$, and x_j in the inside region of $\partial\mathcal{Z}$. Since \mathcal{C} is a Jordan curve, there are two disjoint (simple) curves between x_i and x_j in \mathcal{C} . Both of these x_i, x_j -curves intersect $\partial\mathcal{Z}$. Consider the face in $Int(\mathcal{C}) \cap \mathcal{Z}$ that contains x_j in its boundary. Denote this region (face) by \mathcal{R} .

The boundary $\partial\mathcal{R}$ of \mathcal{R} is a Jordan curve that does not contain any intersection point of type same as x_i . Also, $\partial\mathcal{R}$ contains at least three strings. Indeed, both the strings forming x_j also lie in $\partial\mathcal{R}$ and at least one of the defin-

ing strings of \mathcal{Z} also lies in $\partial\mathcal{R}$. So the vertices corresponding to the strings in $\partial\mathcal{R}$ induces a cycle in C of length less than n and at least 3. This contradicts our assumption that C is a cycle on n vertices. \square

Using [Observation 12](#), we prove the following claim regarding the number of filled zones in \mathbb{C} . Also see [Remark 9](#) for an important distinction that we will have to consider in the proof of [Theorem 8](#) in [Section 3.12](#).

Claim 3. *There is at least one filled zone in \mathbb{C} . Every filled zone in \mathbb{C} contains a $(n - 4)$ -chain.*

Proof. We begin with an outline. For the first part, we consider three cases. If the two strings with the lowest fixed ends do not intersect, then we show that there is a filled zone. Similarly, if the two strings with the highest fixed ends do not intersect, then we show that there is a filled zone. However, if none of the above two cases occur, that is, each pair of strings discussed above intersect, then we first show that the left envelope has at most four strings (the two pairs of strings). Then we show that two of these strings form a filled zone. For the second part, we use [Observation 12](#) and show that any filled zone has a $(n - 4)$ -chain. Now, we give the complete proof.

Recall that we denote the set of strings in \mathbb{C} by $\{s_0, s_1, \dots, s_{n-1}\}$. Also we assumed that, for $i < j$, the fixed point of s_i lies below the fixed point of s_j .

We have three cases depending on whether s_0 intersects s_1 , and whether s_{n-1} intersects s_{n-2} . If s_0 does not intersect s_1 , then s_1 cannot intersect both the neighbours of s_0 . Else a cycle of length four is induced, contradicting $n \geq 5$. Thus there exists a string s_j such that $s_0 \cap s_j \neq \emptyset$ and $s_1 \cap s_j = \emptyset$. Hence the zone \mathcal{Z} of s_0 and s_j supports s_1 , thereby making \mathcal{Z} a filled zone. Similarly, if s_{n-1} does not intersect with s_{n-2} , then we get a filled zone. Now it remains to consider the case where both s_0 intersects s_1 , and s_{n-1} intersects s_{n-2} .

First, we claim that no string other than $\{s_0, s_1, s_{n-2}, s_{n-1}\}$ belongs to the left envelope \mathcal{E} of \mathbb{C} . For sake of contradiction, suppose some s_i , for $2 \leq i \leq n - 3$, belongs to \mathcal{E} . Consider the minimal part of s_i that joins a point in \mathcal{E} to the fixed end of s_i . (It contains just one point in \mathcal{E} .) This part of s_i partitions the inside region of the Jordan curve formed by \mathcal{E} and (part of) the grounding line into two regions, with this part of s_i as their common boundary (see [Corollary 6](#)). Let \mathcal{R}_1 be the region containing the fixed ends of s_0 and s_1 . And let \mathcal{R}_2 be the region containing the fixed ends of s_{n-2} and s_{n-1} .

The string s_i cannot intersect both s_0 and s_1 , else a cycle of length three is induced by strings s_0 , s_1 and s_i , contradicting $n \geq 5$. Similarly, the string s_i cannot intersect both s_{n-2} and s_{n-1} . Fix $s_{0,1} \in \{s_0, s_1\}$ and $s_{n-2, n-1} \in \{s_{n-2}, s_{n-1}\}$ such that s_i does not intersect $s_{0,1}$ and $s_{n-2, n-1}$. Thus $s_{0,1}$ lies in \mathcal{R}_1 and does not intersect with \mathcal{R}_2 . Similarly, $s_{n-2, n-1}$ lies in \mathcal{R}_2 and does not intersect with \mathcal{R}_1 .

Since \mathcal{C} (boundary of the extended face of C) has intersection points on all the strings, consider an intersection point x on $s_{0,1} \cap \mathcal{C}$ and another intersection point y on $s_{n-2, n-1} \cap \mathcal{C}$. As \mathcal{C} is a Jordan curve, there are two internally disjoint x, y -curves on \mathcal{C} . Note that x lies in \mathcal{R}_1 and y lies in \mathcal{R}_2 . Any curve in \mathcal{C} that joins an intersection point in \mathcal{R}_1 to an intersection point in \mathcal{R}_2 , intersects s_i . Thus, both of the x, y -curves on \mathcal{C} , intersect s_i . Consider the region in $\text{Int}(\mathcal{C}) \cap \mathcal{R}_1$ that contains x in its boundary. Denote this region (face) by \mathcal{R}'_1 . This region \mathcal{R}'_1 contains a part of $s_{0,1}$ in its boundary.

The boundary $\partial \mathcal{R}'_1$ of \mathcal{R}'_1 is a Jordan curve. Note that $\partial \mathcal{R}'_1$ does not contain any intersection point on $s_{n-2, n-1}$ (as $s_{n-2, n-1}$ does not intersect with \mathcal{R}_1). And $\partial \mathcal{R}'_1$ consists of at least three strings: both the strings forming x , and s_i . This induces a cycle in C of length less than n and at least 3. This contradicts our assumption that C is a cycle on n vertices. Hence no string other than $\{s_0, s_1, s_{n-2}, s_{n-1}\}$ belongs to the left envelope of \mathcal{C} .

Recall that we are still in the case where both s_0 intersects s_1 , and s_{n-1} intersects s_{n-2} . The left envelope \mathcal{E} of \mathcal{C} is a continuous curve from the fixed end of s_0 (the bottommost fixed end of \mathcal{C}) to the fixed end of s_{n-1} (the topmost fixed end of \mathcal{C}) using the strings in \mathcal{C} . So both s_0 and s_{n-1} belong to the left envelope of \mathcal{C} . Next we claim that a string from $\{s_0, s_1\}$ intersects with a string from $\{s_{n-2}, s_{n-1}\}$. Else, we cannot have a continuous curve from the fixed end of s_0 to the fixed end of s_{n-1} using strings from $\{s_0, s_1, s_{n-2}, s_{n-1}\}$; but \mathcal{E} is such a curve. Furthermore, there is exactly one string from $\{s_0, s_1\}$ that intersects with one string from $\{s_{n-2}, s_{n-1}\}$, else (respecting the degrees of v_0, v_1, v_{n-2} and v_{n-1} in C) a cycle of size four is induced, contradicting $n \geq 5$. Consider the zone \mathcal{Z} of these two intersecting strings (one from $\{s_0, s_1\}$ and one from $\{s_{n-2}, s_{n-1}\}$).

The degree constraints for the corresponding vertices of the defining strings of \mathcal{Z} are already satisfied by adjacencies among v_0, v_1, v_{n-2} and v_{n-1} as we already have assumed that v_0 is adjacent to v_1 , and v_{n-2} is adjacent to

v_{n-1} . Thus no other strings intersect the defining strings of \mathcal{Z} . All the fixed ends of strings s_i for $2 \leq i \leq n-3$ lie in \mathcal{Z} , as the top defining string of \mathcal{Z} is either s_{n-2} or s_{n-1} and the bottom defining string of this zone is either s_0 or s_1 . Thus \mathcal{Z} supports all strings s_i for $2 \leq i \leq n-3$. Hence \mathcal{Z} is a filled zone. This proves the first part of the claim.

To prove the second part of the claim, consider a filled zone \mathcal{Z}' with defining strings s_p and s_q , with $p < q$. Since \mathbb{C} is an outerstring representation of a cycle, each string intersects exactly two other strings. Assume that s_p also intersects $s_{p'}$, and s_q also intersects $s_{q'}$. Now consider a string s_i in \mathbb{C} such that $s_i \notin \{s_p, s_{p'}, s_q, s_{q'}\}$. By [Observation 12](#), s_i has an intersection point in $\text{Int}(\mathcal{Z}')$. Also s_i does not intersect s_p and s_q . Thus \mathcal{Z}' supports s_i . Hence \mathcal{Z}' supports all strings other than $s_p, s_{p'}, s_q$ and $s_{q'}$. Since C is a cycle, there are two $v_{p'}, v_{q'}$ -paths: one is $v_{p'}v_p v_q v_{q'}$, and the other has $(n-4)$ internal vertices $V(C) \setminus \{v_p, v_{p'}, v_q, v_{q'}\}$. The filled zone \mathcal{Z}' supports the strings corresponding to all these internal vertices. Thus the strings that are supported by \mathcal{Z}' induce a $(n-4)$ -chain. Therefore, every filled zone in \mathbb{C} contains a $(n-4)$ -chain. \square

It follows from [Claim 3](#) that the left envelope of any outerstring representation of a cycle contains at most four strings. Indeed, at least $n-4$ strings are supported by the filled zones and thus will not lie on the left envelope. Hence the left envelope contains at most three types of intersection points. We summarize this in the following remark.

Remark 9. The left envelope of \mathbb{C} contains at most three types of intersection points. There are outerstring representations where there are one, two, or three types of intersection points in their left envelope. In the first case (one type of intersection point in the left envelope), there are three filled zones in \mathbb{C} . In the second and third cases (two and three types of intersection point in the left envelope), there is one filled zone in \mathbb{C} . See [Figure 3.16a](#), [Figure 3.16b](#) and [Figure 3.16c](#), respectively.

Remark 10. Since each filled zone supports the strings in a $(n-4)$ -chain, every filled zone in \mathbb{C} will contain the k -face corresponding to cycle C .

Definition. We call such strings that are supported by the filled zone as *intermediate strings*. Note that they do not belong to the left envelope, and they induce a $(n-4)$ -chain.

This completes our study of the structure of the outerstring representa-

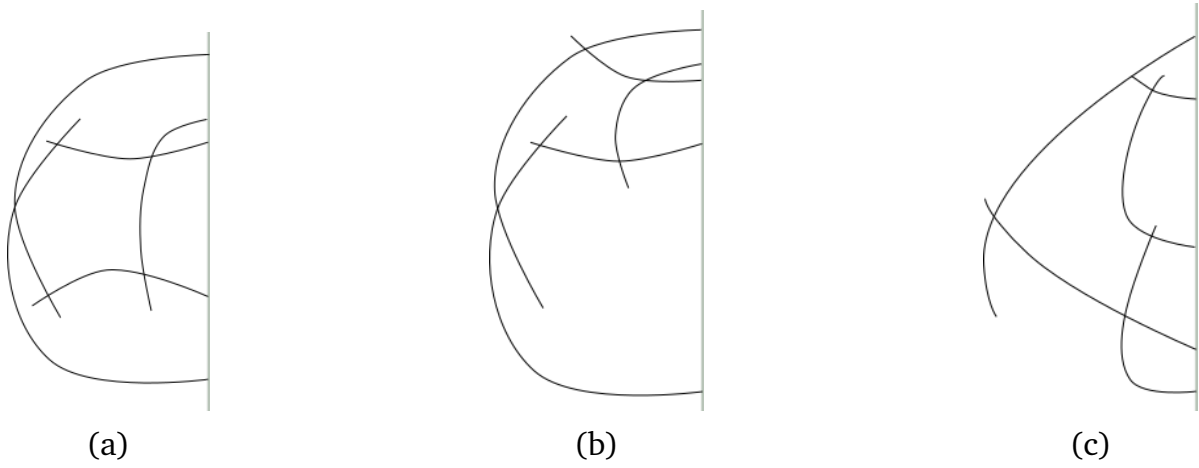

Figure 3.16: Three possibilities of \mathbb{C} with (A) one, (B) two and (C) three types of intersection points in the left envelope, respectively.

tion of a cycle. In the next section, we shall study some basic properties of outerstring representations with girth $g \geq 5$, followed by proving a stronger version of [Theorem 8](#) in the subsequent section.

3.11 Outerstring Representations and Branching Argument

Compared to the corresponding section in outer 1-string graphs ([Section 3.7](#)), there is just one extra remark ([Remark 12](#)) in this section. Rest all are arguments are extended to outerstring graphs without any change.

Consider an outerstring graph OS with girth $g \geq 5$. Observe that the condition $\delta \geq 2$ in [Theorem 8](#) is necessary. Indeed, degree one vertices can forbid the presence of any chain. Henceforth, we shall concentrate on outerstring graphs OS with girth $g \geq 5$ and $\delta \geq 2$. Let \mathbb{OS} be its outerstring representation.

Subclaim 4. *Any filled zone \mathcal{Z} in \mathbb{OS} contains a k -face.*

Proof. Follow the arguments of the proof of [Subclaim 1](#): the corresponding result for outer 1-string graphs. \square

Remark 11 (Branching argument). Recall the *branching argument* in [Remark 8](#). Precisely, if a filled zone is not allowed to have a k -face in it, then we cannot have $\delta \geq 2$, else the forest/tree induced by the strings supported

by the zone has its leaves (except one) with degree one in OS_1 , contradicting our minimum degree restriction.

On the other hand, by a *converse branching argument*, we satisfy the $\delta \geq 2$ requirement, forcing the formation of a k -face.

Remark 12 (No intersection point in a lens). Suppose a pair of strings intersect multiple times. Consider the 2-faces in the induced representation formed by these two strings. We call such regions as *lens* in \mathbb{OS} . There cannot be an intersection point in \mathbb{OS} in the interior of any of these lenses. Else, both the strings forming such an intersection point will intersect the boundary of the lens. This induces a cycle of length three or four is induced in OS , contradicting our girth restriction. Such a line of argument is called as *no intersection point in a lens argument*.

3.12 A Stronger Claim and its Proof

In this section, we prove the following stronger version of [Theorem 8](#).

Claim 4. *Given an outerstring graph OS with girth $g \geq 5$ and $\delta \geq 2$, any filled zone \mathcal{Z} in its outerstring representation completely contains a $(g-4)$ -chain, that is, the strings in this chain lie in $Int(\mathcal{Z})$.*

Proof of [Claim 4](#)

We proceed by strong induction on the number of vertices of OS . For the base case, the smallest graph with girth $g \geq 5$ and $\delta \geq 2$ is a cycle on g vertices. As seen in [Claim 3](#), the intermediate strings in its outerstring representation induce a $(g-4)$ -chain in each of its filled zones. Now assume that in any outerstring graph on less than l vertices with girth $g \geq 5$ and $\delta \geq 2$, every filled zone contains a $(g-4)$ -chain in the outerstring representation.

Let OS be an outerstring graph on l vertices with girth $g \geq 5$ and $\delta \geq 2$, and let \mathbb{OS} be its outerstring representation. Consider a filled zone \mathcal{Z} in \mathbb{OS} . Such a filled zone \mathcal{Z} exists as OS has a cycle in it (see [Claim 3](#)). Let s_t and s_b be the top and bottom defining strings of \mathcal{Z} , respectively. The rest of the proof relies heavily on the following subclaim.

Subclaim 5. *We can safely assume that every string in \mathbb{OS} has an intersection point in $Int(\mathcal{Z})$.*

Proof. Suppose the subclaim does not hold, that is, there is a string s^* that has no intersection point in $Int(\mathcal{Z})$. Then we shall show that $Int(\mathcal{Z})$ contains a $(g - 4)$ -chain. Recall that by [Subclaim 4](#), there is a k -face in \mathcal{Z} .

Case 1. If both the defining strings of \mathcal{Z} , that is s_t and s_b , are the bounding strings of a k -face enclosed in \mathcal{Z} , then remove all the strings, except s_t and s_b , that do not have an intersection point in $Int(\mathcal{Z})$. The graph induced by the remaining strings is an outerstring graph on a smaller number of vertices with girth $g \geq 5$ and $\delta \geq 2$.

Indeed, at least one string (for example s^*) is removed. The girth of a graph does not decrease by deleting vertices. And $\delta \geq 2$ due to the following reasons. Both the strings s_t and s_b have at least two types of intersection points, as they are the bounding strings of the k -face. Every string supported by \mathcal{Z} has at least two types of intersection points. Else such a string has one type of intersection point in \mathbb{OS} , as the removed strings do not intersect it. This contradicts $\delta \geq 2$ for OS . Rest of the strings have an intersection point in $Int(\mathcal{Z})$ as well as intersect s_t or s_b .

Thus, by our induction hypothesis, there is a $(g - 4)$ -chain in $Int(\mathcal{Z})$. The removed strings do not have any intersection point in $Int(\mathcal{Z})$, and thus they do not intersect this chain. Hence this $(g - 4)$ -chain still exists in $Int(\mathcal{Z})$ in \mathbb{OS} .

Case 2. Else, both s_t and s_b are not the bounding strings of the same k -face in \mathcal{Z} . Let \mathcal{F} be a k -face in \mathcal{Z} (existence of \mathcal{F} is implied by [Subclaim 4](#)) with induced sub-representation \mathbb{F} . Let \mathcal{Z}' be a filled zone in \mathbb{F} with top and bottom defining strings s'_t and s'_b , respectively (existence of \mathcal{Z}' is implied by [Claim 3](#)).

Depending on the fixed ends of s_t, s_b, s'_t and s'_b we will have a few cases. The only restrictions that always hold are the following: the fixed end of s_t is above the fixed end of s_b , and the fixed end of s'_t is above the fixed end of s'_b . Let $(s_i s_j s_k s_l)$ denote that the fixed ends of s_i, s_j, s_k and s_l are ordered from top to bottom.

First let us consider the cases where all the four cases are distinct. The possibilities $(s_t s_b s'_t s'_b)$, $(s'_t s'_b s_t s_b)$, and $(s'_t s_t s_b s'_b)$ induce a cycle of length three or four on these four strings, contradicting our girth assumptions. So the remaining possibilities are $(s_t s'_t s_b s'_b)$, $(s'_t s_t s'_b s_b)$, and $(s_t s'_t s_b s'_b)$.

Next, we consider the cases where all the four strings are not distinct.

When $s_t = s'_t$, we have the cases $(s_t = s'_t s'_b s_b)$ and $(s_t = s'_t s_b s'_b)$. When $s_b = s'_b$, we have cases $(s_t s'_t s_b = s'_b)$ and $(s'_t s_t s_b = s'_b)$. The other remaining cases are $(s_t s_b = s'_t s'_b)$ and $(s'_t s'_b = s_t s_b)$.

Many of the cases are of similar nature: $(s'_t s_t s'_b s_b)$ is similar to $(s_t s'_t s_b s'_b)$; $(s_t = s'_t s'_b s_b)$ is similar to $(s_t s'_t s_b = s'_b)$; $(s_t = s'_t s_b s'_b)$ is similar to $(s'_t s_t s_b = s'_b)$; and $(s_t s_b = s'_t s'_b)$ is similar to $(s'_t s'_b = s_t s_b)$. So we shall finally study the following cases: $(s_t s'_t s'_b s_b)$, $(s'_t s_t s'_b s_b)$, $(s_t = s'_t s'_b s_b)$, $(s_t = s'_t s_b s'_b)$, and $(s_t s_b = s'_t s'_b)$. In the second case, we will have two possibilities depending on which of s_t or s_b does s'_t intersect.

We summarize the cases depending on the difficulty level: $(s_t s'_t s'_b s_b)$, $(s_t = s'_t s'_b s_b)$, $(s_t = s'_t s_b s'_b)$, $(s_t s_b = s'_t s'_b)$, and $(s'_t s_t s'_b s_b)$. The last case will have two possibilities depending on which of s_t or s_b does s'_t intersect.

Hence we have to handle the following cases.

- (i) the fixed end of s'_t is below the fixed end of s_t and the fixed end of s'_b is above the fixed end of s_b (see [Figure 3.17a](#)), or
- (ii) without loss of generality, $s'_t = s_t$ and the fixed end of s'_b is above the fixed end of s_b (see [Figure 3.17b](#), [Figure 3.17c](#)), or
- (iii) without loss of generality, $s'_t = s_t$ and the fixed end of s'_b is below the fixed end of s_b (see [Figure 3.17d](#)), or
- (iv) without loss of generality $s_b = s'_t$ (see [Figure 3.17e](#)), or
- (v) without loss of generality, the fixed end of s'_t is above the fixed end of s_t , and the fixed end of s'_b is above the fixed end of s_b , and s'_t intersects s_t (see [Figure 3.17f](#)), or
- (vi) without loss of generality, the fixed end of s'_t is above the fixed end of s_t , and the fixed end of s'_b is above the fixed end of s_b , and s'_t intersects s_b (see [Figure 3.17g](#)).

(i) In the first subcase (see [Figure 3.17a](#)), repeat the above argument of Case 1 for zone \mathcal{Z}' instead of \mathcal{Z} . The induction hypothesis holds as (at least s^* and) at least one of the strings s_t and s_b are removed (both of s_t and s_b cannot have an intersection point in $Int(\mathcal{Z}')$ as then each of them intersect either of s'_t and s'_b , inducing a cycle of length three or four, thereby contradicting our girth

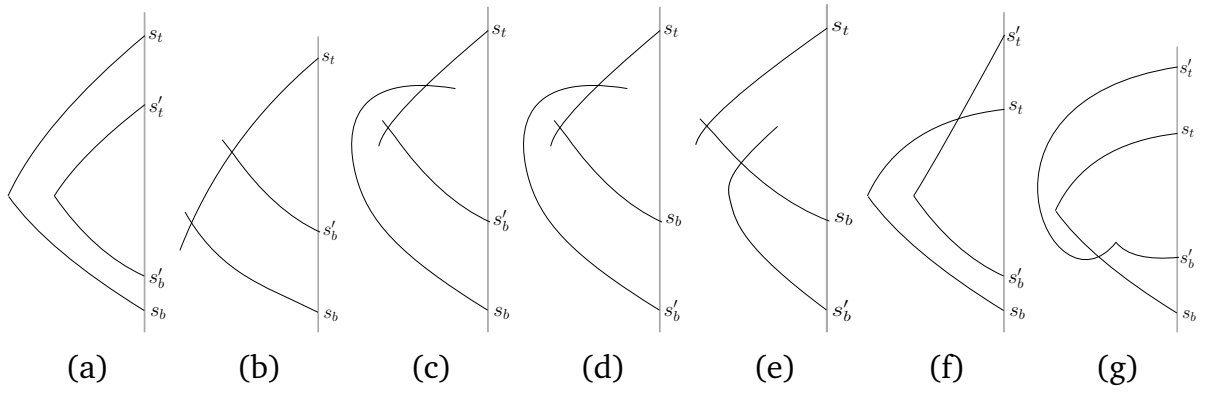

Figure 3.17: Possible configurations for Case 2.

assumption). This holds irrespective of the number of types of intersection points in the left envelope of \mathbb{F} . Thus, by our induction hypothesis, there is a $(g - 4)$ -chain in $Int(\mathcal{Z}')$, which still remains a $(g - 4)$ -chain in $Int(\mathcal{Z}')$ in \mathbb{OS} . This $(g - 4)$ -chain is also in $Int(\mathcal{Z})$. Indeed, there is a pathological case where a lens is formed between say s_t and s'_t . In such a case, we use the no intersection point in a lens argument. Hence, the $(g - 4)$ -chain is also in $Int(\mathcal{Z})$.

(ii) For the second subcase (see [Figure 3.17b](#), [Figure 3.17c](#)), repeat the above argument of Case 1 for zone \mathcal{Z}' instead of \mathcal{Z} . The induction hypothesis holds as at least s^* is removed. Hence there is a $(g - 4)$ -chain in $Int(\mathcal{Z}')$. This holds irrespective of the number of types of intersection points in the left envelope of \mathbb{F} . The $(g - 4)$ -chain in $Int(\mathcal{Z}')$ still remains a $(g - 4)$ -chain in $Int(\mathcal{Z}')$ in \mathbb{OS} . This $(g - 4)$ -chain is also in $Int(\mathcal{Z})$.

(iii) In the third subcase (see [Figure 3.17d](#)), note that since both of s_t and s_b are not the bounding strings of a k -face in \mathcal{Z} , every curve (in \mathcal{Z}) from a point in s_t to a point in s_b goes via some intersection point of the type $s_t \cap s_b$.

Repeat the above argument of Case 1 for zone \mathcal{Z} . If the degree of s_b is at least two, then the resulting representation is an outerstring representation on smaller number of vertices with $g \geq 5$ and $\delta \geq 2$. By our induction hypothesis there is a $(g - 4)$ -chain in each filled zone. This $(g - 4)$ -chain is in $Int(\mathcal{Z})$.

If the degree of s_b is one (after repeating the above argument of Case 1 for zone \mathcal{Z}), then delete s_b . The degree of s_t is at least two, else it reduces to case 2(i). Hence, the resulting representation is an outerstring representation on smaller number of vertices with $g \geq 5$ and $\delta \geq 2$. By our induction hypothesis there is a $(g - 4)$ -chain in each filled zone.

We claim that there is one such $(g - 4)$ -chain in the region that is $Int(\mathcal{Z})$ in the initial outerstring representation before deleting the strings. Clearly, if s_b is not removed, then the claim holds by our induction hypothesis. Else consider the $(g - 4)$ -chain in \mathbb{F} . It lies in the mentioned region (original $Int(\mathcal{Z})$); otherwise, it would have intersected s_b . If any other string intersects this $(g - 4)$ -chain, then by a converse branching argument we will have a k -face and filled zone in $Int(\mathcal{Z})$, thereby reducing this case to Case 2(i) or Case 2(ii). Hence, there is one such $(g - 4)$ -chain in the region that is $Int(\mathcal{Z})$ in the initial outerstring representation before deleting the strings.

None of the removed strings intersect the so obtained $(g - 4)$ -chain. So this $(g - 4)$ -chain is also in $Int(\mathcal{Z})$ in \mathbb{OS} .

(iv) The fourth subcase (see [Figure 3.17e](#)) is similar to the third subcase. Note that since both of s_t and s_b are not the bounding strings of a k -face in \mathcal{Z} , every curve (in \mathcal{Z}) from a point in s_t to a point in s_b goes via some intersection point of the type $s_t \cap s_b$. Otherwise, there exists a k -face with s_t and s_b as bounding strings.

Repeat the above argument of Case 1 for zone \mathcal{Z} . If the degree of s_t remains at least two, then the resulting representation is an outerstring representation on smaller number of vertices with $g \geq 5$ and $\delta \geq 2$. By our induction hypothesis there is a $(g - 4)$ -chain in each filled zone. This $(g - 4)$ -chain is in $Int(\mathcal{Z})$.

If the degree of s_t becomes one (after repeating the above argument of Case 1 for zone \mathcal{Z}), then delete s_t . The degree of $s_b (= s'_t)$ is at least two, as it is a bounding string of \mathcal{F} and s'_t is not deleted (as it has an intersection point in $Int(\mathcal{Z})$). Hence, the resulting representation is an outerstring representation on smaller number of vertices with $g \geq 5$ and $\delta \geq 2$. By our induction hypothesis there is a $(g - 4)$ -chain in each filled zone.

By following the corresponding part in the third subcase (or otherwise) we can show that there is one such $(g - 4)$ -chain in the region that is $Int(\mathcal{Z})$ in the initial outerstring representation before deleting the strings.

None of the removed strings intersect the so obtained $(g - 4)$ -chain. So this $(g - 4)$ -chain is also in $Int(\mathcal{Z})$ in \mathbb{OS} .

(v) In the fifth subcase (see [Figure 3.17f](#)), we use the following property. Since both the strings s_t and s_b are not the bounding strings of the same k -

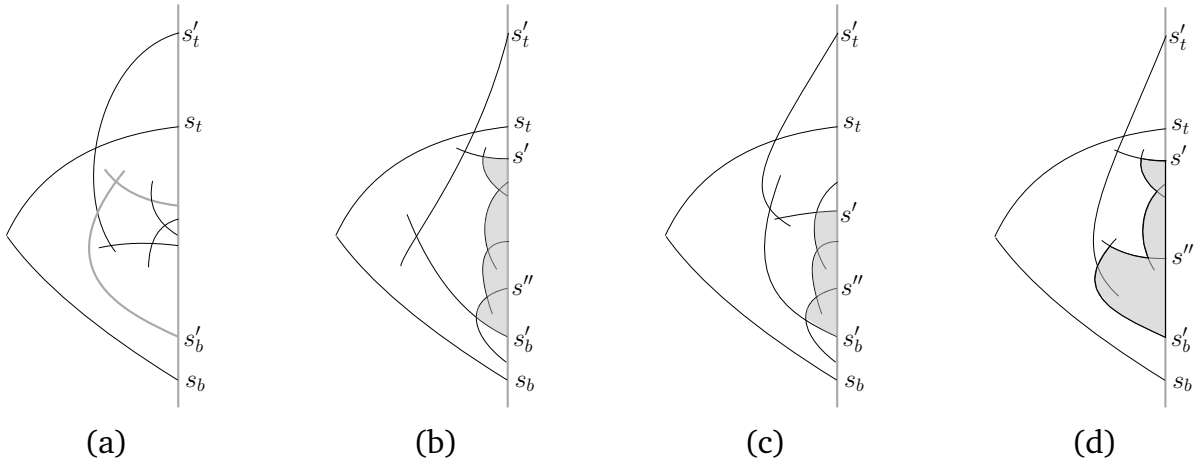

Figure 3.18: Possibilities of Case 2(v)

face in \mathcal{Z} , so any curve (formed by parts of strings in \mathbb{OS}) from a point on s_b to s'_b goes via s_t . Otherwise, there exists a k -face with s_t and s_b as bounding strings.

Hence any string intersecting s'_b (other than s'_t) does not intersect s_b . Furthermore, any string intersecting s'_b also does not intersect s_t , else a cycle of length four is induced, contradicting our girth assumption. Now we further subdivide this subcase into three parts depending on the number of types of intersection points in the left envelope of \mathbb{F} . Furthermore, among all possibilities of \mathcal{F} , we choose an \mathcal{F} such that the fixed end of s'_b is the lowest.

- (a) Consider the case where the left envelope of \mathbb{F} has just one type of intersection point. Then it has three filled zones (see [Remark 9](#)) containing the k -face \mathcal{F} . One of these three filled zones (highlighted in [Figure 3.18a](#)) is completely contained in $Int(\mathcal{Z})$. Note that s_t does not intersect the defining strings of the highlighted filled zone, else it contradicts our girth assumption. This reduces this subcase to Case 2(i). So there is a $(g - 4)$ -chain in $Int(\mathcal{Z})$. See [Figure 3.18a](#).
- (b) Consider the case where the left envelope of \mathbb{F} has three types of intersection points. Let $s' (\neq s'_b)$ be the other string in \mathbb{F} that intersects s'_t . (Recall that the bounding strings of \mathcal{F} induces a cycle.) Note that the fixed end of s' cannot be above the fixed end of s'_t , else s_t intersects both s' and s'_t inducing a cycle of length three, thereby contradicting our girth assumption. Let $s'' (\neq s'_t)$ be the other string in \mathbb{F} that intersects s'_b . The fixed end of s'' can either be in $Int(\mathcal{Z}')$ or outside it.

We claim that s'' and the intermediate strings except the one intersecting s' induce a $(g - 4)$ -chain. Suppose some string intersects any of the intermediate strings mentioned in the above claim, then by a converse branching argument there is a k -face in one of the highlighted regions in [Figure 3.18b](#). So there is a filled zone in \mathcal{Z} containing a k -face.

Note that the bounding strings of this k -face cannot intersect either s_b or s_t (else it either contradicts that s_t and s_b are not the bounding strings of a k -face or it contradicts our girth assumption, respectively). So this subcase eventually reduces to Case 2(i). So the mentioned intermediate strings form a $(g - 5)$ -chain. For the same reason no other string intersects s'' in $\text{Int}(\mathcal{Z}')$. Next suppose a string intersects s'' outside \mathcal{Z}' , then by a converse branching argument there is a k -face outside \mathcal{Z}' . This contradicts the choice of \mathcal{F} . As s'' intersects an end of the $(g - 5)$ -chain formed by the mentioned intermediate strings, all these strings combine to induce a $(g - 4)$ -chain, which lies completely in $\text{Int}(\mathcal{Z})$. See [Figure 3.18b](#).

(c) Consider the case where the left envelope of \mathbb{F} has two types of intersection points. Let $s'(\neq s'_b)$ be the other string in \mathbb{F} that intersects s'_t . Let $s''(\neq s'_t)$ be the other string in \mathbb{F} that intersects s'_b . Irrespective of whether this configuration is as shown in [Figure 3.18c](#) or [Figure 3.18d](#), proceed exactly as in Case 2(iv)(b) to get the $(g - 4)$ -chain that is completely contained in $\text{Int}(\mathcal{Z})$. When the configuration is as shown in [Figure 3.18d](#), there is a minor deviation from Case 2(iv)(b) with respect to the contradiction obtained for more than two strings intersecting s'' . Here the part where the choice of \mathcal{F} is contradicted does not arise. Rest all the arguments are the same.

(v) The analysis of the sixth subcase (see [Figure 3.17g](#)) is very similar to the fifth subcase. In the sixth subcase we use the following property. Since both the strings s_t and s_b are not the bounding strings of the same k -face in \mathcal{Z} , so any curve (formed by parts of strings in \mathbb{OS}) from a point on s_t to s'_b goes via s_b . Otherwise, there exists a k -face with s_t and s_b as bounding strings.

Now we further subdivide into three parts depending on the number of types of intersection points in the left envelope of \mathbb{F} . Furthermore, among all possibilities of \mathcal{F} , we choose an \mathcal{F} such that the fixed end of s' is the highest, where $s'(\neq s'_b)$ be the other string in \mathbb{F} that intersects s'_t .

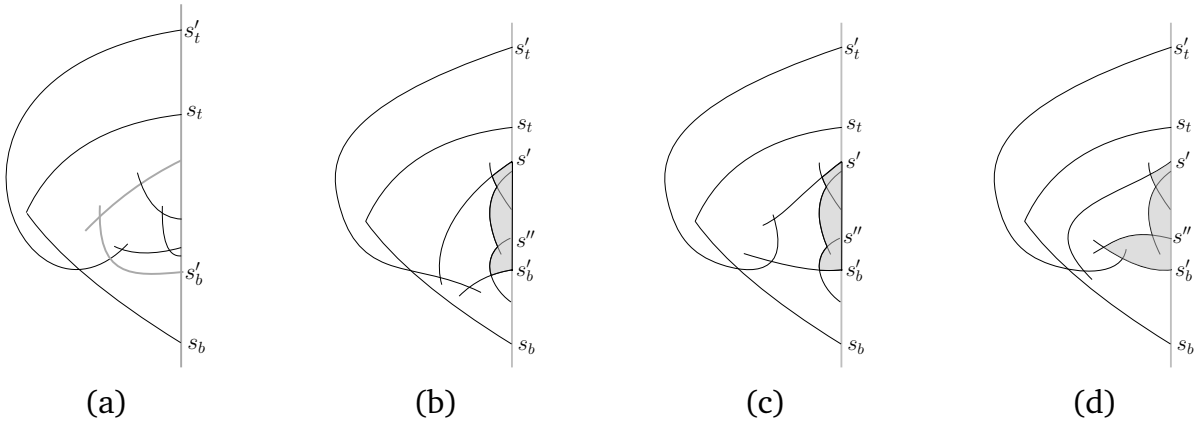

Figure 3.19: Possibilities of Case 2(vi)

- (a) Consider the case where the left envelope of \mathbb{F} has just one type of intersection point. Then it has three filled zones (see Remark 9) containing the k -face \mathcal{F} . One of these three filled zones (highlighted in Figure 3.19a) is completely contained in $Int(\mathcal{Z})$. Note that s_b does not intersect the defining strings of the highlighted filled zone, else a cycle of length four is induced, contradicting our girth assumption. This reduces this subcase to Case 2(i). So there is a $(g - 4)$ -chain in $Int(\mathcal{Z})$. See Figure 3.19a.
- (b) Consider the case where the left envelope of \mathbb{F} has three types of intersection points. Let $s' (\neq s'_b)$ be the other string in \mathbb{F} that intersects s'_t . (Recall that the bounding strings of \mathcal{F} induces a cycle.) Let $s'' (\neq s'_t)$ be the other string in \mathbb{F} that intersects s'_b .

We claim that the intermediate strings induce a $(g - 4)$ -chain. Suppose some string intersects the intermediate string in the highlighted regions in Figure 3.19b, then by a converse branching argument there is a k -face in one of the highlighted region. So there is a filled zone in \mathcal{Z} containing a k -face. Note that none of the bounding strings of this k -face can intersect either s_t or s_b (else it either contradicts that s_t and s_b are not the bounding strings of a k -face or it contradicts our girth assumption, respectively). So this subcase eventually reduces to Case 2(i).

Next suppose some string intersects the intermediate string (intersecting s') in the region bounded by s_t, s_b, s'_t, s' and the grounding line, then by a converse branching argument there is a k -face in this region. This contradicts the choice of \mathcal{F} . Hence the intermediate strings induce a $(g - 4)$ -chain, which lies completely in $Int(\mathcal{Z})$. See Figure 3.19b.

(c) Consider the case where the left envelope of \mathbb{F} has two types of intersection points. Let $s'(\neq s'_b)$ be the other string in \mathbb{F} that intersects s'_t . Let $s''(\neq s'_t)$ be the other string in \mathbb{F} that intersects s'_b . Irrespective of whether this configuration is isomorphic to the figures in [Figure 3.19c](#) or [Figure 3.19d](#), proceed exactly as in Case 2(iii)(b) to get the $(g - 4)$ -chain that is completely contained in $Int(\mathcal{Z})$.

Therefore, we can safely assume that every string in \mathbb{OS} has an intersection point in $Int(\mathcal{Z})$. \square

We can also safely assume that OS is not isomorphic to the cycle on l vertices. Indeed, we have proved [Claim 4](#) for cycles in [Claim 3](#). Hence there are at least two (induced) cycles in OS . In order to prove [Claim 4](#), next, we prove the following.

Subclaim 6. \mathbb{OS} has at least two filled zones.

Proof. Since there are two induced cycles in OS , there will be two distinct k -faces, say \mathcal{F}_1 and \mathcal{F}_2 , in \mathbb{OS} . Hence there is at least one filled zone in each of \mathbb{F}_1 and \mathbb{F}_2 . Since a filled zone is uniquely determined by its defining strings, we need to show that there exists filled zones \mathcal{Z}_1 in \mathbb{F}_1 , and \mathcal{Z}_2 in \mathbb{F}_2 that do not have the same defining strings.

Suppose \mathcal{Z}_1 and \mathcal{Z}_2 have the same set of defining strings, say s_t and s_b . This implies $\mathcal{Z}_1 = \mathcal{Z}_2 = \mathcal{Z}$ (say). Both \mathcal{F}_1 and \mathcal{F}_2 have an intersection point of the same type as $s_t \cap s_b$ in their boundary. If there is just one intersection point of the same type as $s_t \cap s_b$, then follow the arguments of the corresponding subclaim ([Subclaim 2](#)) for outer 1-string graphs to reach the required conclusion. Thus, there are multiple intersection points of the same type as $s_t \cap s_b$. Now \mathcal{F}_1 and \mathcal{F}_2 can have different intersection points of the same type as $s_t \cap s_b$. Hence, there exists a string s that intersects either s_t or s_b and separates \mathcal{F}_1 and \mathcal{F}_2 . Without loss of generality assume that \mathcal{F}_1 lies *between* s and s_t and \mathcal{F}_2 lies *between* s and s_b .

Suppose s intersects s_t . Then the zone of s and s_t is filled as there are at least three more bounding strings of \mathcal{F}_1 and one of them is enclosed by this zone (by [Observation 10](#) and [Claim 3](#)). Notice that one of the bounding strings of \mathcal{F}_2 , or otherwise, which is at a distance two from s cannot intersect s or s_t (else it contradicts our girth assumption). Hence, it does not have an intersection point in the zone of s and s_t , thereby contradicting [Subclaim 5](#).

We get a similar contradiction if s intersects s_b . Thus, \mathcal{Z}_1 and \mathcal{Z}_2 do not have the same set of defining strings.

Hence there are at least two distinct filled zones. \square

Next, using [Subclaim 6](#), we find some possible configurations.

The possible configurations

Let the two distinct filled zones be \mathcal{Z}_1 in \mathbb{F}_1 , and \mathcal{Z}_2 in \mathbb{F}_2 . Let s_{t_1} and s_{b_1} be the top and bottom defining strings of \mathcal{Z}_1 . Let s_{t_2} and s_{b_2} be the top and bottom defining strings of \mathcal{Z}_2 . Without loss of generality, assume that the fixed end of s_{t_1} is above or at the fixed end of s_{t_2} .

First we consider the case where all the strings s_{t_1} , s_{b_1} , s_{t_2} and s_{b_2} are distinct. The string s_{t_1} has to intersect either of s_{t_2} or s_{b_2} to have an intersection point in $Int(\mathcal{Z}_2)$ (by [Subclaim 5](#)).

If s_{t_1} intersects s_{t_2} , then first we claim that s_{b_1} is enclosed in \mathcal{Z}_2 . Otherwise, to satisfy [Subclaim 5](#), s_{b_1} intersects either of s_{t_2} or s_{b_2} inducing a cycle of length three or four. This contradicts our girth assumption. The above argument also implies that s_{b_2} has no intersection point in $Int(\mathcal{Z}_1)$, as it cannot intersect either of s_{t_1} or s_{b_1} (because of our girth assumption). This contradicts [Subclaim 5](#).

If s_{t_1} intersects s_{b_2} , then we claim that s_{b_1} is enclosed in \mathcal{Z}_2 . Otherwise, to satisfy [Subclaim 5](#), s_{b_1} intersects either of s_{t_2} or s_{b_2} inducing a cycle of length three or four. This contradicts our girth assumption. Hence s_{t_2} is enclosed in \mathcal{Z}_1 . This is a possible configuration (see [Figure 3.20a](#)).

Next, suppose without loss of generality, $s_{t_1} = s_{t_2}$. Also without loss of generality assume that the fixed end of s_{b_2} is lower than the fixed end of s_{b_1} . Then s_{b_1} does not intersect s_{b_2} , else it contradicts our girth assumption. Also s_{b_2} has an intersection point in \mathcal{Z}_1 . So s_{b_2} intersects s_{t_1} and then enters \mathcal{Z}_1 (by [Subclaim 5](#)). This results in two possible configurations (see [Figure 3.20b](#) and [Figure 3.20c](#)).

Next, it remains to consider the case when $s_{b_1} = s_{t_2}$. Without loss of generality, suppose s_{b_2} crosses $s_{b_1} (= s_{t_2})$ to enter $Int(\mathcal{Z}_1)$ (by [Subclaim 5](#)). Also by [Subclaim 5](#), s_{t_1} has an intersection point in $Int(\mathcal{Z}_2)$. But s_{t_1} cannot intersect s_{b_2} , else a cycle of length three is induced by strings s_{t_1} , s_{b_1} and s_{b_2} . This contradicts our girth assumption. Thus, string s_{t_1} crosses s_{b_1} once again

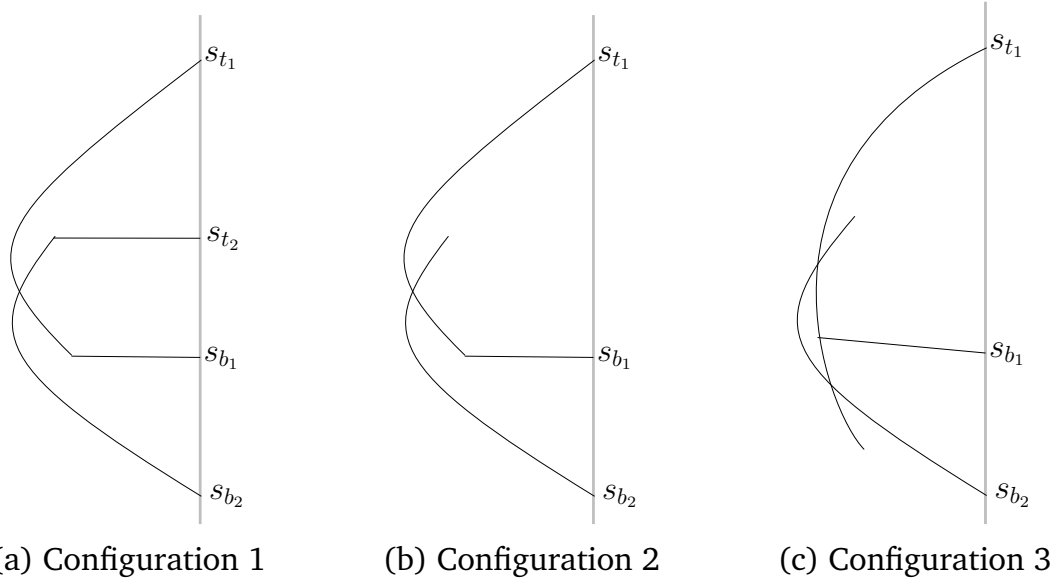

Figure 3.20: Final two configurations to be checked.

and enters $Int(\mathcal{Z}_2)$, but then \mathcal{Z}_1 is modified and s_{b_1} does not have an intersection point in $Int(\mathcal{Z}_1)$. This contradicts [Subclaim 5](#). Continuing this line of argument, one always contradicts [Subclaim 5](#). Hence, such a case would not occur.

So we have to consider the configurations as shown in [Figure 3.20a](#), [Figure 3.20b](#) and [Figure 3.20c](#).

Configuration 1

First consider the configuration as shown in [Figure 3.20a](#). Recall that faces \mathcal{F}_1 and \mathcal{F}_2 contains intersection points of same type as $s_{t_1} \cap s_{b_1}$ and $s_{t_2} \cap s_{b_2}$, respectively, in their boundary. Let $p(s_{b_2})$ be the *smallest* part of s_{b_2} between the intersection points of same type as $s_{t_2} \cap s_{b_2}$ and $s_{t_1} \cap s_{b_2}$, and let $p(s_{b_1})$ be the *smallest* part of s_{b_1} between the intersection points $s_{t_1} \cap s_{b_1}$ and $s_{t_1} \cap s_{b_2}$. Since \mathcal{F}_1 and \mathcal{F}_2 are distinct, a curve from a point in interior in \mathcal{F}_1 to a point in the interior of \mathcal{F}_2 intersects their bounding strings. Hence, without loss of generality, assume that there is a bounding string of \mathcal{F}_2 that intersects (has a point in) $p(s_{b_2})$. The fixed end of this bounding string is between the fixed ends of s_{t_1} and s_{b_1} , else it contradicts our girth assumption.

If its fixed end is between the fixed ends of s_{t_2} and s_{b_1} , then the zone of this string and s_{b_2} is filled, as it supports s_{b_1} . The other bounding string of \mathcal{F}_2 (other than s_{b_2}) that intersects s_{t_2} does not have any intersection point in this

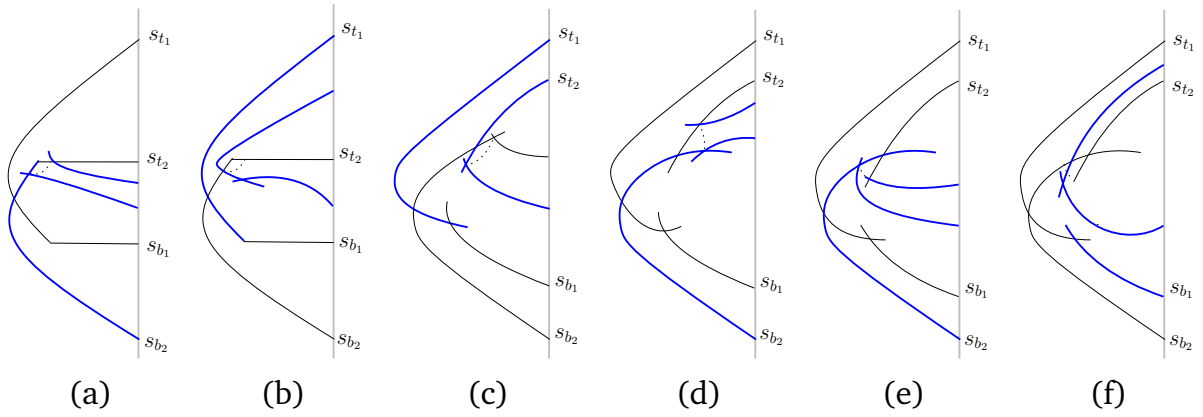

Figure 3.21: Possibilities of the first configuration.

filled zone, else it contradicts our girth assumption (see Figure 3.21a). This contradicts Subclaim 5.

If its fixed end is between the fixed ends of s_{t_1} and s_{t_2} , then the zone of this string and the other bounding string of \mathcal{F}_2 it intersects (other than s_{b_2}) is filled, as it supports s_{t_2} . Note that the string s_{t_1} has no intersection point in this filled zone, else it contradicts our girth assumption (see Figure 3.21b). This contradicts Subclaim 5.

Similarly, there are no bounding string of \mathcal{F}_1 that has a point in $p(s_{b_1})$. Hence none of \mathcal{F}_1 and \mathcal{F}_2 have three types of intersection points in its left envelope. Suppose \mathcal{F}_2 has just one type of intersection point in its left envelope. Then the zone of the strings s_{t_2} and the other bounding string of \mathcal{F}_2 intersecting s_{t_2} (other than s_{b_2}) is filled as it supports the other bounding string of \mathcal{F}_2 intersecting s_{b_2} . Note that the string s_{t_1} has no intersection point in this filled zone (see Figure 3.21c). This contradicts Subclaim 5.

Next, suppose \mathcal{F}_2 has two types of intersection points in its left envelope. There there are three possibilities as shown in Figure 3.21d, Figure 3.21e and Figure 3.21f. In first two possibilities (Figure 3.21d and Figure 3.21e), the zone formed by s_{b_2} and the other bounding string of \mathcal{F}_2 (other than s_{t_2}) intersecting s_{b_2} is filled as it supports s_{b_1} . Note that the bounding string (say s) intersecting s_{t_2} other than s_{b_2} has no intersection point in this filled zone (see Figure 3.21d and Figure 3.21e). (There are two possibilities for Figure 3.21d depending on the location of fixed end of s with respect to that of s_{t_2} . However our argument holds for both the cases.) In the third possibility (Figure 3.21f), the zone formed by the other bounding string of \mathcal{F}_2 string intersecting s_{b_2} (other than s_{t_2}) and the other bounding string of \mathcal{F}_2 intersecting it is filled

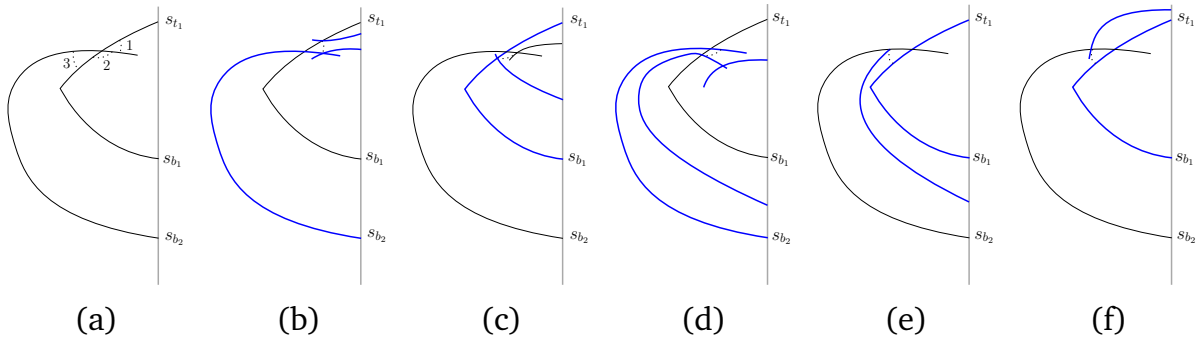

Figure 3.22: Possibilities of the second configuration.

as it supports s_{t_2} . Note that the string s_{b_1} has no intersection point in this filled zone, else it contradicts our girth assumption (see [Figure 3.21f](#)). This contradicts [Subclaim 5](#).

Hence the configuration shown in [Figure 3.20a](#) is not possible.

Configuration 2

Next we consider the configuration as shown in [Figure 3.20b](#). Recall that faces \mathcal{F}_1 and \mathcal{F}_2 contains intersection points $s_{t_1} \cap s_{b_1}$ and $s_{t_2} \cap s_{b_2}$, respectively, in their boundary. Depending on the relative location of \mathcal{F}_2 with respect to the strings s_{t_1} and s_{b_2} , we will have three cases as shown in [Figure 3.22a](#).

For the Case 1, the zone formed by the strings s_{b_2} and the other bounding string of \mathcal{F}_2 intersecting s_{b_2} (other than s_{t_1}) is filled as it supports s_{b_1} . Note that the bounding string of \mathcal{F}_2 intersecting s_{t_1} (other than s_{b_2}) has no intersection point in this filled zone (see [Figure 3.22b](#)). This contradicts [Subclaim 5](#).

For the Case 2, there is a bounding string of \mathcal{F}_2 has a point in s_{t_1} between $s_{t_1} \cap s_{b_1}$ and $s_{t_1} \cap s_{b_2}$. Its fixed end is either between the fixed ends of s_{t_1} and s_{b_1} , or between the fixed ends of s_{b_1} and s_{b_2} .

For the former, the zone by this string and s_{t_1} is filled as it supports at least one bounding string of \mathcal{F}_2 (the one intersecting s_{b_2} , other than s_{t_1}). Note that the string s_{b_1} has no intersection point in the interior of this filled zone (see [Figure 3.22c](#)). This contradicts [Subclaim 5](#). It might be possible that s_{b_1} intersects s_{t_1} once again to enter this filled zone. But then also s_{b_1} does not have an intersection point in this filled zone, else \mathcal{F}_2 is not a face. It might also be possible that s_{b_1} intersects s_{t_1} once again to be a bounding string of \mathcal{F}_2 . But in this case, the zone by s_{b_1} and the other bounding string of \mathcal{F}_2 it

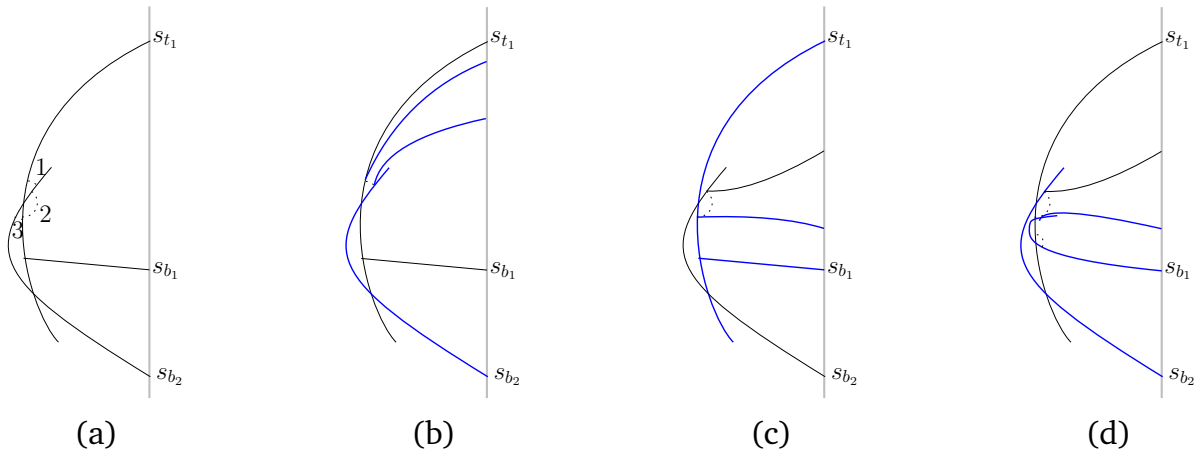

Figure 3.23: Possibilities of the third configuration.

intersects is filled (it supports some bounding string of \mathcal{F}_1). And the string s_{b_2} has no intersection point in it. This contradicts [Subclaim 5](#).

For the latter, the zone by this string and the bounding string of \mathcal{F}_2 it intersects other than s_{t_1} is filled as it supports s_{b_1} . Note that the string s_{b_2} has no intersection point in this filled zone (see [Figure 3.22d](#)). This contradicts [Subclaim 5](#).

For the Case 3, consider the filled zone formed by the strings s_{t_1} and s_{b_1} . It supports the intermediate strings of \mathbb{F}_1 . The bounding string of \mathcal{F}_2 (other than s_{t_1}), that intersects s_{b_2} has no intersection point in this filled zone (see [Figure 3.22e](#) and [Figure 3.22f](#)). This contradicts [Subclaim 5](#).

Hence the configuration shown in [Figure 3.20b](#) is also not possible.

Configuration 3

Next we consider the configuration as shown in [Figure 3.20c](#). Recall that faces \mathcal{F}_1 and \mathcal{F}_2 contains intersection points $s_{t_1} \cap s_{b_1}$ and $s_{t_2} \cap s_{b_2}$, respectively, in their boundary. Depending on the relative location of \mathcal{F}_2 with respect to the strings s_{t_1} and s_{b_2} , we will have three cases as shown in [Figure 3.23a](#).

For the Case 1, the zone formed by the strings s_{b_2} and the other bounding string of \mathcal{F}_2 intersecting s_{b_2} (other than s_{t_1}) is filled as it supports s_{b_1} . Note that the bounding string of \mathcal{F}_2 intersecting s_{t_1} (other than s_{b_2}) has no intersection point in this filled zone (see [Figure 3.23b](#)). This contradicts [Subclaim 5](#).

For the Case 2, there is a bounding string of \mathcal{F}_2 has a point in s_{t_1} between $s_{t_1} \cap s_{b_1}$ and $s_{t_1} \cap s_{b_2}$. Its fixed end is between the fixed ends of s_{t_1} and s_{b_1} .

The zone by this bounding string and s_{t_1} is filled as it supports at least one bounding string of \mathcal{F}_2 (the one intersecting s_{b_2} , other than s_{t_1}). Note that the string s_{b_1} has no intersection point in the interior of this filled zone (see [Figure 3.23c](#)). This contradicts [Subclaim 5](#). It might be possible that s_{b_1} intersects s_{t_1} once again to enter this filled zone. But then also s_{b_1} does not have an intersection point in this filled zone, else \mathcal{F}_2 is not a face. It might also be possible that s_{b_1} intersects s_{t_1} once again to be a bounding string of \mathcal{F}_2 . But in this case, the zone by s_{b_1} and the other bounding string of \mathcal{F}_2 it intersects is filled (it supports some bounding string of \mathcal{F}_1). And the string s_{b_2} has no intersection point in it (see [Figure 3.23d](#)). This contradicts [Subclaim 5](#).

Using the no intersection point in a lens argument ([Remark 12](#)), one can see that Case 3 would not occur.

So all the configurations as shown in [Figure 3.20a](#), [Figure 3.20b](#) and [Figure 3.20c](#) are not possible. This concludes the proof of [Claim 4](#). \square

3.13 Consequences of Theorem 8

In the spirit of the corollaries presented by Esperet and Ochem [[EO09](#)] on circle graphs, there are a few consequences of [Theorem 8](#). We present the results for outerstring graphs: they also hold for grounded-L graphs and outer 1-string graphs. The first two consequences holds for any 2-degenerate graphs.

The *list-chromatic number* of a graph G is the minimum k such that for any assignments of k -lists of colors to each vertex, the vertices are colored from the lists assigned to them with adjacent vertices receiving different colors.

Using a greedy coloring argument, we can show that a k -degenerate graph is $(k + 1)$ -list-colorable. Furthermore, odd cycles have list-chromatic-number 3. Hence defining

$$\chi_l(\mathcal{G}, k) := \max_{G \in \mathcal{G}} \{\chi_l(G) \mid \text{girth}(G) \geq k\},$$

we have the following stronger version of [Corollary 3](#).

Corollary 7. $\chi_l(\text{OUTERSTRING}, 5) = 3$.

The *ramsey number* of a graph H , denoted $r(H)$, is the minimum n such that in every two-coloring of K_n , there exists a monochromatic copy of H . It

is well-known that the ramsey number of K_t is exponential in t . Proving a conjecture of Erdős and Burr [BE73], Lee [Lee17] showed that for every k -degenerate graph H on n vertices, its ramsey number is at most cn , where c is a constant (c.f., the exponential nature in K_t). Hence Theorem 8 implies the following corollary.

Corollary 8. *The ramsey number of a outerstring graph of girth at least five grows linearly in the number of vertices.*

The rest of the consequences mentioned below require the presence of $(g - 4)$ -chain as proven in Theorem 8.

The *circular chromatic number* of a graph G , denoted $\chi_c(G)$, is the infimum of the set of real numbers r such that there exists a mapping of $V(G)$ to the set of unit length open arcs of a circle with circumference r which maps adjacent vertices to disjoint arcs. It is known that this infimum can be achieved, and $\lceil \chi_c(G) \rceil = \chi(G)$ (see [Zhu01]).

Corollary 2.2 of [GGH01] and Theorem 8 imply the following (also see [EO09]).

Corollary 9. *Every outerstring graph G with girth $g \geq 5$ has circular chromatic number*

$$\chi_c(G) \leq 2 + \frac{1}{\lfloor \frac{g-3}{2} \rfloor}.$$

The *maximum average degree* of a graph G , denoted $mad(G)$, is defined as

$$mad(G) = \max_{H \subseteq G} \left\{ \frac{2E(H)}{V(H)} \right\}.$$

Using Theorem 8, one can inductively prove the following.

Corollary 10. *Every outerstring graph G with girth $g \geq 5$ has maximum average degree*

$$mad(G) < 2 + \frac{2}{g-4}.$$

Proof. We proceed by strong induction on n . The base case is easy to verify: as the smallest graph with girth g is a cycle on g vertices, which is a grounded-L graph. Assume the claim is true for outerstring graphs whose order is less than n . Let G be an outerstring graph on n vertices. From Theorem 8, the

graph G contains a chain of $g - 4$ vertices of degree two. Let G' be the graph obtained by removing these $g - 4$ vertices of degree two. Let the girth of G' be g' . Since G' is a subgraph of G , we have $g' \geq g$. From our induction assumption,

$$\text{mad}(G') < 2 + \frac{2}{g' - 4} \leq 2 + \frac{2}{g - 4}.$$

It remains to show that $\text{mad}(G)$ satisfies the above inequality.

Let H be a minimal subgraph of G such that the average degree of H is $\text{mad}(G)$. One can see that H is connected. Let $|V(H)| = n_H$. Clearly $\text{mad}(G) \geq \text{mad}(G')$. It suffices to consider the case when $\text{mad}(G) > \text{mad}(G')$. In this case H contains some (say x) vertices from the $g - 4$ vertices added to G' . Since H is connected these vertices induce a path. Let H'' be the graph obtained from H by removing these x vertices. By our induction hypothesis, the average degree of H'' is less than $2 + 2/(g - 4)$. Upon adding x vertices we add at most $x + 1$ edges. So,

$$\text{mad}(G) = \frac{2|E_H|}{|V_H|} < \frac{1}{n_H} \left[(n_H - x) \left(2 + \frac{2}{g - 4} \right) + 2x + 2 \right] < 2 + \frac{2}{g - 4}.$$

This completes the proof of [Corollary 10](#). □

Recently, Dross, Montassier, and Pinlou [[DMP18](#)] proved that the vertex of a graph that has maximum average degree less than three can be partitioned into an independent set and a set that induces a forest. So [Corollary 10](#) implies the following.

Corollary 11. *The vertex set of any outerstring graph G with girth $g \geq 6$ can be partitioned into an independent set and a set that induces a forest.*

Also, as a consequence of [Corollary 10](#), we also have the following result on the circular choice number. For definition see [[Zhu05](#)], and for relation with maximum average degree see [[HKM⁺09](#), Prop. 43] (also see [[EO09](#)]).

Corollary 12. *Every outerstring graph G with girth $g \geq 5$ has circular choice number*

$$\text{cch}(G) < 2 + \frac{4}{g - 2}.$$

3.14 Final Remarks

3.14.1 Acknowledgements

First, we would thank Kostochka and Nešetřil for their elegant proof in [KN98]. It was this elegance that kept us going, although our proofs turned out to be a lot messier.

We thank the reviewers of both EuroCG 2021 and EUROCOMB 2021 for their valuable suggestions on paper versions of this chapter that greatly enhanced both the content and the presentation.

This work was partially supported by the IFCAM project “Applications of graph homomorphisms” (MA/IFCAM/18/39).

.

4 Bend Graphs

Contents

4.1	Introduction	140
4.1.1	The Setup and Definitions	141
4.2	Our Results	142
4.2.1	The Class \mathcal{B}_k	142
4.2.2	The Class $\text{PROPER-}\mathcal{B}_k$	144
4.3	The Lower Bounding Argument	145
4.3.1	Idea	145
4.3.2	The target graph	145
4.3.3	k -sets and good k -sets	146
4.3.4	A far enough k -set	148
4.3.5	A lower bounding lemma	150
4.4	Proof of Theorem 9	151
4.5	Proof of Theorem 10	152
4.5.1	Proof of Lemma 16	153
4.6	The Lower Bound	157
4.7	The Upper Bound Construction	160
4.7.1	Proof of Lemma 17	160
4.8	Final Remarks	165
4.8.1	A Digression from our Theme	165
4.8.2	Acknowledgements	165

4.1 Introduction

In this chapter, we continue our study of geometric intersection graphs, in particular, string graphs but with a geometric and combinatorial flavour. Consider a string graph and its string representation. We can embed the strings in a fine enough grid such that rectilinear curves replace the strings while inducing an isomorphic arrangement. Informally, we call it as a *bend representation*. Thus, every string graph has such a bend representation. In fact, it follows that the class of graphs having a bend representation is equivalent to the string graphs (see Asinowski et al. [ACG⁺12] and also see Coury et

al. [CHK⁺10]).

We begin by building a setup to formally define these graphs. Recall from the introduction chapter (Chapter 1) that we consider only VPG graphs (subsection 1.4.2) and refer to them as *bend graphs*.

4.1.1 The Setup and Definitions

Our setup of defining the representations is motivated by that of Çela and Saar [CG20]. Consider a large enough rectangular grid. The vertical and horizontal lines are called *grid lines*. Two crossing grid lines intersect at a *grid point*. Two grid points are *consecutive* if either they lie on the same vertical line and there is no grid point in the part of this vertical line between them, or they lie on the same horizontal line and there is no grid point in the part of this horizontal line between them. A *grid edge* is the part of a grid line between two consecutive grid points. Two grid edges are *consecutive* if they have a common endpoint. Consider a path composed of a sequence of consecutive grid edges. A right-angle turn of this path on a grid is called a *bend*. A *bend point* is a grid point where a path has a bend. A *k-bend path* is a path with k bends. A *segment* of a k -bend path is a set of consecutive grid edges between two ‘consecutive’ bend points. A segment can be either *horizontal* or *vertical*. Thus a k -bend path consists of $k + 1$ segments that alternately are horizontal and vertical.

Depending on the notion of *intersection*, we can define various types of representations and the resulting graph classes. We begin with the most general definition. Two paths *intersect* if they have at least one grid point in common. A graph has a bend representation if its vertices can be mapped to paths in the grid such that there is an edge between two vertices if and only if the corresponding paths intersect. The *bend number* of a path is the number of bends in it. The *bend number* of a representation is the maximum of the bend number of its constituent paths. The *bend number* of a graph is the minimum bend number of all its bend representations.

To define the next type of representation, we tweak the definition of intersection. Two paths *properly intersect* if they *intersect* and have no two consecutive grid points in common. This implies that there is a finite number of common points between any two paths. A graph has a proper bend repre-

sentation if its vertices can be mapped to simple paths in the grid such that there is an edge between two vertices if and only if the corresponding paths properly intersect. Correspondingly, the *proper bend number* of a graph is the minimum bend number of all its proper bend representations.

As mentioned in the beginning of this chapter, the class of string graphs is equivalent to the class of "bend graphs". Thus, every string graph has a finite bend number. Depending on its bend number we can group string graphs into a sequence of nested graph classes. Define \mathcal{B}_k as the graph class that contains exactly the string graphs with bend number at most k . Extending the ideas of Asinowski et al. [ACG⁺12], as stated in the beginning of this chapter, we can also show that the class of string graphs is equivalent to the class of "proper bend graphs". Thus, every string graph has a finite proper bend number, and hence can form the nested graph classes as in the case of bend number. Now similar to \mathcal{B}_k , we can define $\text{PROPER-}\mathcal{B}_k$ as the graph class that contains exactly the string graphs with proper bend number at most k .

In Section 4.2, we present our results: two theorems on bend graphs (in subsection 4.2.1), and one theorem on proper bend graphs (in subsection 4.2.2). In Section 4.3, 4.4 and 4.5, we prove the two results on bend graphs. We start by giving a common lower bounding argument in Section 4.3. Using this lower bounding technique, we prove the two results in Section 4.4 and 4.5, respectively. In Section 4.6 and 4.7, we prove our result on proper bend graphs. The lower bound is derived in Section 4.6 and the upper bound construction is given in Section 4.7.

4.2 Our Results

4.2.1 The Class \mathcal{B}_k

As mentioned earlier, the following containment relations are obvious from the definition of \mathcal{B}_k .

$$\mathcal{B}_0 \subseteq \mathcal{B}_1 \subseteq \dots \subseteq \mathcal{B}_k \subseteq \mathcal{B}_{k+1} \dots$$

Asinowski et al. [ACG⁺12] proved strict containment of \mathcal{B}_0 in \mathcal{B}_1 , that is, $\mathcal{B}_0 \subsetneq \mathcal{B}_1$. They conjectured that this strict containment continues for

all k , that is, $\mathcal{B}_k \subsetneq \mathcal{B}_{k+1}$ for all $k \geq 0$. These questions are not straightforward to address in case of geometric intersection graphs (see Cabello and Jeřič [CJ17] for similar questions).

Chaplick et al. [CJK⁺12] proved the conjecture of Asinowski et al. [ACG⁺12]. However, their constructed examples were not chordal. In this regard, they posed [Open question 1](#), which is restated here for convenience.

Open question 1. *Is $\text{CHORDAL-}\mathcal{B}_k \subsetneq \text{CHORDAL-}\mathcal{B}_{k+1}$, for all $k \geq 0$?*

Addressing the above open question is the main purpose of this chapter. In fact, other questions that are addressed in this chapter have their roots in [Open question 1](#). We address [Open question 1](#) by proving the following result. Note that $\text{SPLIT} \subset \text{CHORDAL}$.

Theorem 9. *There exists infinitely many values of k such that $\text{SPLIT-}\mathcal{B}_k \subsetneq \text{SPLIT-}\mathcal{B}_{k+1}$.*

In order to prove [Theorem 9](#), we first prove that for all $k \in \mathbb{N}$, there exists a split graph G of order $n + \binom{n}{k}$, whose bend number is strictly greater than $k/2 - 8$ (see [Section 4.3](#)). Then we give a bend representation of G with bend number $f(k) = 2\binom{n-1}{k-1} - 1$ (see [Theorem 15](#) and [Remark 13](#) in [Section 4.4](#)). Thus, G is a separating example between $\text{SPLIT-}\mathcal{B}_{k/2-8}$ and $\text{SPLIT-}\mathcal{B}_{f(k)}$; and hence G is a separating example between $\text{SPLIT-}\mathcal{B}_t$ and $\text{SPLIT-}\mathcal{B}_{t+1}$, for some $k/2 - 8 \leq t < f(k)$.

Although [Theorem 9](#) is a first step in addressing [Open question 1](#), we note that $f(k)$ is exponential in k , that is, there is an exponential gap between the upper and lower bounds. Can we do any better if we relax the graph class a bit? This is addressed in our next result.

The question asked by Chaplick et al. [CJK⁺12] concerns chordal separating examples between \mathcal{B}_k and \mathcal{B}_{k+1} . Chordal graphs are precisely the graphs that are free of induced cycles of length at least four, that is, $\text{CHORDAL} \equiv \text{FORB}(C_{\geq 4})$. If we apply our techniques used to prove [Theorem 9](#) to the string graphs in $\text{FORB}(C_{\geq 5})$ (that is, we allow induced 4-cycles in our graphs), then we can restrict $f(k)$ to be linear in k . This is our next result.

Theorem 10. *For all $t \in \mathbb{N}$, $\text{FORB}(C_{\geq 5})\text{-}\mathcal{B}_t \subsetneq \text{FORB}(C_{\geq 5})\text{-}\mathcal{B}_{4t+29}$.*

The above questions relating to the graph class \mathcal{B}_k are addressed in [Section 4.3](#), [4.4](#) and [4.5](#). Next, we address similar questions on the graph class $\text{PROPER-}\mathcal{B}_k$.

4.2.2 The Class $\text{PROPER-}\mathcal{B}_k$

The problems addressed till now had no restriction on the number of intersection points between two paths. What if one does not allow any overlapping intersection, that is, there are finite number of intersection points between any two paths. Chaplick et al. [[CJK⁺12](#)] considered this and defined a proper bend representation as one where (1) the paths are simple, (2) there are finite intersection points, and (3) each intersection point belongs to exactly two paths at which they cross. This is captured by our earlier definition, where we also defined proper bend number and the graph classes $\text{PROPER-}\mathcal{B}_k$. The following containment relations are obvious from the definition of $\text{PROPER-}\mathcal{B}_k$.

$$\text{PROPER-}\mathcal{B}_0 \subseteq \text{PROPER-}\mathcal{B}_1 \subseteq \dots \subseteq \text{PROPER-}\mathcal{B}_k \subseteq \text{PROPER-}\mathcal{B}_{k+1} \dots$$

We continue our study of strict containment relations (and separating examples) for these graph classes defined based on the proper bend number. Although, the above results for class \mathcal{B}_k also hold for $\text{PROPER-}\mathcal{B}_k$ as the proper bend number of a string graph is at least its bend number, and the upper bound constructions are all proper bend representations¹, we can do much better. Using completely different techniques, we prove the following.

Theorem 11. *For all $t \in \mathbb{N}$, $\text{SPLIT-PROPER-}\mathcal{B}_t \not\subseteq \text{SPLIT-PROPER-}\mathcal{B}_{36t+80}$.*

As in the previous cases, this involves a lower bounding argument and an upper bound construction. These are presented in [Section 4.6](#) and [Section 4.7](#), respectively.

CLASS \mathcal{B}_k

As mentioned earlier, we begin with the lower bounding technique for proving [Theorem 9](#) and [Theorem 10](#).

¹The upper bound construction in [Theorem 9](#) (see [Theorem 15](#)) can be modified to obtain a proper bend representation with the same number of bends per path.

4.3 The Lower Bounding Argument

4.3.1 Idea

The idea of the lower bound is simple. Suppose we have a bend representation with two sets of paths: one a *base* set and another a *derived* set. If there exists a path in the derived set such that each of its segment intersects at most, say, two paths of the base set of paths, then this path from the derived set has to turn once it intersects two paths. The bend number of this derived path will be lower bounded by about half of its degree. And this has to happen for any bend representation of the string graph.

To exploit this idea, we need to make sure that the minimum degree of the paths in the derived set is large enough. This can be done by ensuring that each derived path intersects a fixed number of base paths. Also, we need to make sure that the resulting graph is a chordal graph. This can be done by ensuring that the base paths induce a clique and the derived paths are independent. In fact, the resulting graph will be a split graph. We have a few things to take care of.

Next, we define a graph class based on the above intuition. Our result on the lower bound holds for this more general class of string graphs than the chordal (split) ones we need. This helps us in proving [Theorem 10](#).

4.3.2 The target graph

For $n, k \in \mathbb{N}$ with $n > k$, define a family of graphs $\mathcal{H}_{n,k}$ as follows. Let $\binom{[n]}{k}$ denote the set of k -element subsets of $[n]$. A graph G is in $\mathcal{H}_{n,k}$ if its vertex set $V(G) = [n] \cup \binom{[n]}{k}$ and its edge set $E(G)$ can be partitioned into two sets $E_1(G)$ and $E_2(G)$ such that

$$E_1(G) = \{uv : u \neq v, \forall u, v \in [n]\} \cup \{wS : \forall S \in \binom{[n]}{k}, \forall w \in S\}$$

and

$$E_2(G) \subseteq \{ST : S \neq T, \forall S, T \in \binom{[n]}{k}\}.$$

Notice that we do not specify anything about the subgraph induced on vertex set $\binom{[n]}{k}$. This is what allows $\mathcal{H}_{n,k}$ to be a more general class than we need to

address [Theorem 9](#).

For a fixed constant $t \in \mathbb{N}$, fix $k = 2t + 16$ and $n = k^2k! + 3$ and let G_t denote any graph in the family $\mathcal{H}_{n,k}$ (the need for such values of n, k will become clear later, and these were obtained by a bit of backtracking). The degrees of the vertices in $\binom{[n]}{k}$ (*derived* vertices) are equal, and we can make G_t chordal by setting $E_2(G_t) = \emptyset$. This takes care of our concerns raised above. However, there is one main thing to take care of: the assumption that there exists a path representing a vertex in $\binom{[n]}{k}$ such that each of its segment intersects at most, say, two paths representing the vertices in $[n]$. This is what we handle next in [subsection 4.3.4](#). Before that we develop a mathematical framework to incorporate our intuitions.

We aim to prove that $\text{bend}(G_t) > t$. For sake of contradiction, assume G_t has a \mathcal{B}_t representation $\mathcal{R} = \{P(u)\}_{u \in V(G_t)}$. Let $\mathcal{R}_A = \{P(a) : a \in [n]\}$. We need a few definitions.

The set of horizontal and vertical lines obtained by extending the horizontal and vertical segments of all the paths in \mathcal{R}_A , along with the set of horizontal and vertical lines passing through both the endpoints of each path in \mathcal{R}_A is called the *grid* induced by \mathcal{R}_A . The horizontal and vertical lines so formed are called *grid lines*. A *vertical strip* is the part of the plane between two consecutive vertical grid lines in the grid induced by \mathcal{R}_A . Similarly, a *horizontal strip* is the part of the plane between two consecutive horizontal lines of the grid induced by \mathcal{R}_A . By *grid line segments* we mean the parts of vertical grid lines in horizontal strips, and the parts of horizontal grid lines in vertical strips.

4.3.3 k -sets and good k -sets

Let \mathcal{G} be the rectangle formed by the extreme horizontal grid lines and extreme vertical grid lines. For every point $p \in \mathcal{G}$, we define two sets $H(p), V(p) \subseteq A$ as follows. A set $A' \subseteq A$ is said to be a ‘horizontal set’ of p if there exists a horizontal line segment with left end-point p such that the paths in \mathcal{R}_A that it intersects are exactly the ones in $\{P(a) : a \in A'\}$. Similarly, a set $A' \subseteq A$ is said to be a ‘vertical set’ of p if there exists a vertical line segment with bottom end-point p that intersects exactly the paths in \mathcal{R}_A that correspond to vertices of A' . Let $H(p)$ be the largest horizontal set of A with

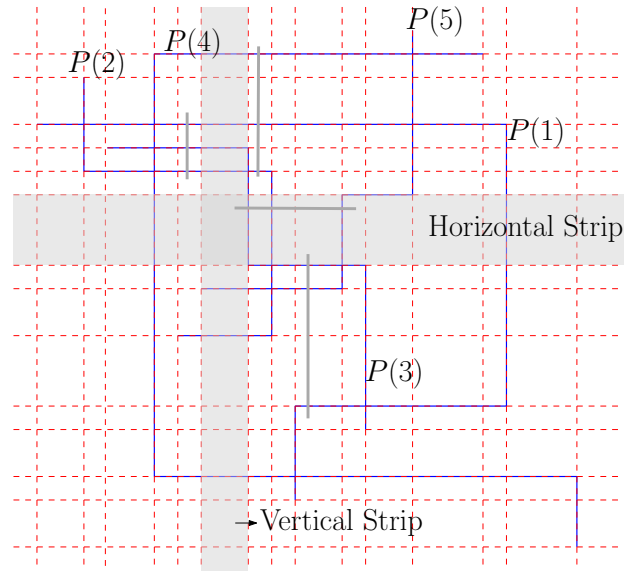

Figure 4.1: Grid induced by \mathcal{R}_A of $G \in \mathcal{H}_{5,3}$: (1) dotted lines represent the grid lines, (2) normal lines represent the paths $P(a), a \in [5]$ and (3) thick gray lines intersect some good 3-sets.

cardinality at most k and $V(p)$ be the largest vertical set of p with cardinality at most k . Note that it is possible for either of $H(p)$ or $V(p)$ to be empty. See Figure 4.1 for an illustration.

Let $S = \bigcup_{p \in \mathcal{G}} \{H(p), V(p)\}$. Let a *cell* be an open arc-connected region of \mathcal{G} after removing the vertical and horizontal grid lines. Note that for any two points p, p' that lie in the interior of a cell, we have $H(p) = H(p')$ and $V(p) = V(p')$. Similarly, for any two points p, p' that lie on a vertical or horizontal grid line segment, we have $H(p) = H(p')$ and $V(p) = V(p')$. Therefore, $|S|$ is at most the sum of the number of cells and number of horizontal and vertical grid line segments. As the number of horizontal and vertical grid lines is at most $n(t + 3)$, we have

$$|S| \leq 3n^2(t + 3)^2 \leq n^2k^2.$$

For each $X \in S$, let X' denote an arbitrarily chosen k -set (subset of A of cardinality k) such that $X \subseteq X'$. Let $S' = \{X' : X \in S\}$. Clearly $|S'| = |S|$. Therefore, S' is a collection of at most n^2k^2 k -sets. We call the k -sets in S' as *good k -sets*.

4.3.4 A far enough k -set

Next in [Observation 13](#), we prove the existence of a k -set which has at most two elements from each good k -set. For this, we count the number of k -sets whose at most $k - 3$ elements differ from a good k -set. Using the bound on $|S'|$, we find an upper bound to the number of k -sets whose at most $k - 3$ elements differ from any good k -set. For value of n as fixed above ($n = k^2k! + 3$), this turns out to be strictly less than $\binom{n}{k}$, thereby proving the result.

Observation 13. *There exists a k -set that contains at most two elements from each good k -set.*

Proof. Let \mathcal{S} be the set of all good k -sets in \mathcal{R}_A . For a good k -set $S \in \mathcal{S}$, let \mathcal{T}_S be the set of k -sets whose at most $k - 3$ elements differ from a good k -set. The total number of k -sets is $\binom{n}{k}$. Therefore, to prove the observation, it is sufficient to prove the following claim.

Claim 5 (A).

$$\left| \bigcup_{S \in \mathcal{S}} \mathcal{T}_S \right| < \binom{n}{k}.$$

Proof. Let S be a good k -set in \mathcal{S} . Then in order to get a k -set whose i elements differ from S , we replace i elements in S with i elements not in S . So

$$|\mathcal{T}_S| = \sum_{i=0}^{k-3} \binom{k}{i} \binom{n-k}{i}.$$

In the following inequality, we give an upper bound on $|\mathcal{T}_S|$.

$$|\mathcal{T}_S| = \sum_{i=1}^{k-3} \binom{k}{i} \binom{n-k}{i} + 1 < (k-3) \binom{k}{\lceil k/2 \rceil} \binom{n-k}{k-3} \quad (4.1)$$

The inequality follows as n is much larger compared to k . Since the total number of good k -sets is upper bounded by n^2k^2 , inequality 4.1 implies the following upper bound on $\left| \bigcup_{S \in \mathcal{S}} \mathcal{T}_S \right|$ i.e. the total number of k -sets whose at most $k - 3$ elements differ from any good k -set.

$$\left| \bigcup_{S \in \mathcal{S}} \mathcal{T}_S \right| \leq n^2k^2(k-3) \binom{k}{\lceil k/2 \rceil} \binom{n-k}{k-3}$$

We require the following two inequalities.

Subclaim 7. For $k \geq 16$ we have,

$$k! < \left\lceil \frac{k}{2} \right\rceil! \left\lfloor \frac{k}{2} \right\rfloor! (k-5)!$$

Subclaim 8. For $n > k^2k! + 2$ and $k \geq 16$ we have,

$$n^2k^2(n-k)! < \frac{n!(n-2k+3)!}{k!(n-k)!}.$$

Before we prove these subclaims, we show how they imply Claim (A).

$$\begin{aligned} \left| \bigcup_{S \in \mathcal{S}} \mathcal{T}_S \right| &\leq n^2k^2(k-3) \binom{k}{\lceil k/2 \rceil} \binom{n-k}{k-3} \\ &= n^2k^2(k-3) \frac{k!}{\lceil k/2 \rceil! \lfloor k/2 \rfloor!} \frac{(n-k)!}{(n-2k+3)!(k-3)!} \\ &= [n^2k^2(n-k)!] \left[\frac{k!}{\lceil k/2 \rceil! \lfloor k/2 \rfloor! (k-5)!} \right] \frac{(k-3)}{(k-3)(k-4)(n-2k+3)!} \\ &< \frac{n!(n-2k+3)!}{k!(n-k)!} \frac{1}{(k-4)(n-2k+3)!} \quad (\text{using Subclaims 7 and 8}) \\ &= \binom{n}{k} \frac{1}{(k-4)} \\ &< \binom{n}{k} \quad (\text{since } k \geq 16) \end{aligned}$$

So [Subclaim 7](#) and [8](#) imply Claim (A). Now we prove [Subclaim 7](#) and [8](#).

Proof of [Subclaim 7](#). We consider both the cases depending on the parity of k i.e. whether $k = 2m$ or $k = 2m + 1$. In both these cases the required inequality can be proved by showing that $(2m)! < m!m!(2m-5)!$, for $m \geq 8$. Since $(2m)! < (2m)^5(2m-5)!$ and $(\frac{m}{3})^m (\frac{m}{3})^m \leq m!m!$ (as for any $n \geq 6$, $(\frac{n}{3})^n \leq n! \leq (\frac{n}{2})^n$), it is enough to prove the following.

$$\begin{aligned} (2m)^5 &< \left(\frac{m}{3}\right)^{2m} \\ \Rightarrow m &> 3^{\frac{2m}{2m-5}} \cdot 32^{\frac{1}{2m-5}} \end{aligned}$$

For $m = 8$, the above inequality holds. Observe, for $m \geq 8$, $3^{\frac{2m}{2m-5}} \cdot 32^{\frac{1}{2m-5}}$ is a decreasing function in m . Hence for $m \geq 8$ the inequality holds.

Hence $(2m)! < m!m!(2m-5)!$. This ends the proof of [Subclaim 7](#). ◀

Proof of [Subclaim 8](#). It is sufficient to prove the following simplified inequality.

$$n^2k^2k!(n-k)(n-k-1)\dots(n-2k+4) < n(n-1)(n-2)(n-3)\dots(n-k+1)$$

Observe that $(n-k)(n-k-1)\dots(n-2k+4) < (n-3)(n-4)\dots(n-k+1)$, since every term in RHS is greater than the corresponding term in LHS (as $k \geq 16$).

Hence it is sufficient to prove the following:

$$\begin{aligned} n^2 k^2 k! &< n(n-1)(n-2) \\ \Leftrightarrow k^2 k! &< n-3 + \frac{2}{n} \end{aligned}$$

For $n > k^2 k! + 2$, the above inequality is satisfied. This ends the proof of Subclaim 8. ◀

This completes the proof of [Observation 13](#). □

Now we find a lower bound for the bend number of G_t .

4.3.5 A lower bounding lemma

Lemma 14 (Lower Bounding Lemma). *There exists a vertex $B \in V(G_t)$ such that $P(B)$ has at least $\frac{k}{2} - 1$ bends.*

Proof. By [Observation 13](#), there exists a k -set T that contains at most two elements from each good k -set. By the definition of G_t , there exists a vertex $B \in V(G_t)$ such that $N(B) = T$. Consider a vertical line segment l of $P(B)$. Suppose that it intersects three different paths $P(a_1), P(a_2), P(a_3)$ in \mathcal{R}_A . Let l' be the line segment $l \cap \mathcal{G}$. As the paths $P(a_1), P(a_2), P(a_3)$ are all contained in \mathcal{G} , l' intersects these three paths too (therefore l' is non-empty). Let p be the bottom end-point of l' . Clearly, l' intersects at most k different paths in \mathcal{R}_A as the path $P(B)$ itself intersects only k different paths from \mathcal{R}_A . Then $Q = \{a \in A : l' \text{ intersects } P(a)\}$ is a vertical set of p with cardinality at most k . It follows from the definition of $V(p)$ that $Q \subseteq V(p)$, implying that $a_1, a_2, a_3 \in V(p)$. Therefore, there is a good k -set that contains a_1, a_2 and a_3 , which are all elements of T . This is a contradiction as T contains at most two elements from each good k -set. So every vertical line segment of $P(B)$ intersects at most two different paths in \mathcal{R}_A . It can similarly be shown that each horizontal segment of $P(B)$ intersects at most two different paths in \mathcal{R}_A . If t' is the number of bends that $P(B)$ has, then there are $t' + 1$ segments in $P(B)$, and

it follows from the reasoning above that $2(t' + 1) \geq k$. This gives $t' \geq \frac{k}{2} - 1$. Hence $P(B)$ has at least $\frac{k}{2} - 1$ bends. \square

Recall that a graph G is in $\mathcal{H}_{n,k}$ if its vertex set $V(G) = [n] \cup \binom{[n]}{k}$ and its edge set $E(G) = E_1(G) \cup E_2(G)$ such that $E_1(G) = \{uv : u \neq v, \forall u, v \in [n]\} \cup \{wS : \forall S \in \binom{[n]}{k}, \forall w \in S\}$ and $E_2(G) \subseteq \{ST : S \neq T, \forall S, T \in \binom{[n]}{k}\}$. Now we are ready to prove [Theorem 9](#) and [Theorem 10](#). We restate [Theorem 9](#) here for convenience.

Theorem 9. *There exists infinitely many values of k such that $\text{SPLIT-}\mathcal{B}_k \subsetneq \text{SPLIT-}\mathcal{B}_{k+1}$.*

4.4 Proof of [Theorem 9](#)

For $n, k \in \mathbb{N}$ with $n > k$, let K_n^k be the split graph whose vertex set can be partitioned into a clique C having n vertices and an independent set I of size $\binom{n}{k}$ such that for any subset $C' \subset C$ with $|C'| = k$, there is a unique vertex $u \in I$ with $N(u) = C'$. For a fixed constant $t \in \mathbb{N}$, fix $k = 2t + 16$ and $n = k^2 k! + 3$ and let G_t denote the graph K_n^k . Notice that G_t is a graph in the family $\mathcal{H}_{n,k}$. Suppose G_t has a \mathcal{B}_t representation \mathcal{R} . Let $\mathcal{R}_A = \{P(a) : a \in [n], P(a) \in \mathcal{R}\}$. Then by [Observation 13](#), there is a k -set T which has at most two elements common with any good k' -set in \mathcal{R}_A , where $k' \leq k$. Since T is a k -element subset of $[n]$ there is a vertex $B \in V(G_t)$ such that $N(B) = T$. By [Lemma 14](#), $P(B)$ has at least $\frac{k}{2} - 1$ bends in \mathcal{R} . This contradicts our assumption and hence $\text{bend}(G_t) > t$. So for each $t \in \mathbb{N}$, there is a split graph G which has no B_t -VPG representation but has $B_{t'}$ -VPG representation for some finite $t' > t$ (as split graphs are known to be string graphs; also see [Theorem 15](#) below). Hence for each $t \in \mathbb{N}$, there exists a $t' > t$ such that $\text{SPLIT-}\mathcal{B}_t \subsetneq \text{SPLIT-}\mathcal{B}_{t'}$. So there must exist an m with $t \leq m < t'$ such that $\text{SPLIT-}\mathcal{B}_m \subsetneq \text{SPLIT-}\mathcal{B}_{m+1}$. This concludes the proof of [Theorem 9](#). \square

Although, the proof of [Theorem 9](#) is complete, we give an upper bound construction of a split graph in general, which implies the promised upper bound construction for K_n^k (see [Remark 13](#)).

Theorem 15. *Let G be a split graph with clique partition C and independent set partition I . Then $\text{bend}(G) \leq 2\Delta_c - 1$ where $\Delta_c = \max\{|N(v) \cap I| : v \in C\}$.*

Proof. Let $C = \{v_1, v_2, \dots, v_c\}$ and $I = \{u_1, u_2, \dots, u_m\}$. For each $j \in [m]$, we first draw a horizontal segment l_j whose left endpoint is at $(2j, 2j)$ and right endpoint is at $(2j + 1, 2j)$.

Now we draw the paths corresponding to the vertices of C and I . For each $j \in [m]$, we draw $P(u_j)$ as a vertical segment whose top endpoint is at $(2j + \frac{1}{2}, 2j - \frac{1}{2})$ and bottom endpoint is at $(2j + \frac{1}{2}, 2j + \frac{1}{2})$. For each $j \in [m]$, let the label of l_j be $N(u_j)$. For each $i \in [c]$, let $L_i = \{l_{i_1}, l_{i_2}, \dots, l_{i_t}\}$ with $t = |N[v_i] \cap I|$ and $i_1 < i_2 < \dots < i_t$ be the horizontal segments such that v_i belongs to the label of l_{i_j} for each $j \in [t]$. For each $i \in [c]$, we draw $P(v_i)$ by joining $(0, 0)$ with the left endpoint of l_{i_1} using a 1-bend rectilinear path and then for each $j \in [|N(v_i) \cap I| - 1]$ we join the left endpoint of l_{i_j} with the left endpoint of $l_{i_{j+1}}$ using a 1-bend rectilinear path that contains l_{i_j} as subpath.

It is not difficult to verify that the union of $\{P(v)\}_{v \in C}$ and $\{P(u)\}_{u \in I}$ is a valid bend representation of G . The number of bends in $P(u)$ for each $u \in I$ is 0. For each $v \in C$, $P(v)$ has exactly $2|N(v) \cap I| - 1$ bends i.e. at most $2\Delta_c - 1$ bends where $\Delta_c = \max\{|N(v) \cap I| : v \in C\}$. This concludes the proof. \square

Remark 13. In the above discussion, we have a lower bound on the bend number of K_k^n for each $k \in \mathbb{N}$ and sufficiently large $n \in \mathbb{N}$. [Theorem 15](#) implies that the bend number of all split graphs is upper bounded by $2\Delta_c - 1$, where $\Delta_c = \max\{|N(v) \cap I| : v \in C\}$. It follows that the bend number of such split graphs is at most $2\binom{n-1}{k-1} - 1$.

Next, we prove [Theorem 10](#), restated here for convenience.

Theorem 10. For all $t \in \mathbb{N}$, $\text{FORB}(C_{\geq 5})\text{-}\mathcal{B}_t \not\subseteq \text{FORB}(C_{\geq 5})\text{-}\mathcal{B}_{4t+29}$.

4.5 Proof of Theorem 10

For a fixed constant $t \in \mathbb{N}$, fix $k = 2t + 16$ and $n = k^2k! + 3$. Let G_t be the graph with vertex set $V(G_t) = [n] \cup \binom{[n]}{k}$ and its edge set $E(G_t) = \{uv : u \neq v, \forall u, v \in [n]\} \cup \{wS : \forall S \in \binom{[n]}{k}, \forall w \in S\} \cup \{ST : S \neq T, \forall S, T \in \binom{[n]}{k}\}$.

We claim that for any $t \in \mathbb{N}$, the graph G_t is in $\text{Forb}(C_{\geq 5})$. Note that $\overline{G_t}$ is a bipartite graph. So it cannot contain $\overline{C_p}$, for any $p \geq 5$, as an induced subgraph (as $\overline{C_5} = C_5$ and $\overline{C_p}$, for any $p > 5$, contains a triangle). So G_t cannot contain an induced cycle on five or more vertices i.e. $G_t \in \text{Forb}(C_{\geq 5})$.

Notice that the graph G_t belongs to the graph family $\mathcal{H}_{n,k}$. Hence, following similar arguments used in [Section 4.3](#), the bend number of G_t is strictly greater than t . The following lemma gives a $\text{PROPER-}\mathcal{B}_{4t+29}$ representation for G_t .

Lemma 16. *The graph G_t belongs to $\text{PROPER-}\mathcal{B}_{4t+29}$.*

Hence, the bend number of G_t is strictly greater than t and at most $4t+29$. This proves [Theorem 10](#).

4.5.1 Proof of Lemma 16

Now we shall give a \mathcal{B}_{4t+29} representation of G_t ; in fact, we give its $\text{PROPER-}\mathcal{B}_{4t+29}$ representation. First we introduce the following definitions. Recall that $k \geq 2t + 16$ and $n = 2k^2k! + 3$.

Let \mathcal{R} be a \mathcal{B}_l representation of a $G \in \mathcal{B}_l$, and $P(v)$ be a path in \mathcal{R} corresponding to a vertex $v \in V(G)$. *Corner points* of a k -bend path are the end points of the horizontal and vertical segments of the path. Let p_1, \dots, p_r be the corner points encountered while traversing the the path $P(v)$ from p_1 to p_r , where p_1, p_r are the endpoints of $P(v)$. The *direction vector* f of $P(v)$ is a vector of size $r - 1$ where each entry is a symbol from $\{\rightarrow, \leftarrow, \downarrow, \uparrow\}$. For some $i \in \{1, 2, \dots, r - 1\}$, let f_i denote the i th entry of the direction vector of $P(v)$ in \mathcal{R} . If f_i is \rightarrow , then it means that p_{i+1} lies horizontally right of p_i ; if f_i is \leftarrow , then it means that p_{i+1} lies horizontally left of p_i ; if f_i is \downarrow , then it means that p_{i+1} lies vertically below p_i ; and if f_i is \uparrow , then it means that p_{i+1} lies vertically above p_i .

We call a part of a horizontal (vertical) segment of $P(v)$ is *exposed from below* (resp. *exposed from left*) in \mathcal{R} , if a vertical (resp. horizontal) ray drawn downwards (resp. leftwards) from any point in this part does not intersect with any path $P(u)$ in \mathcal{R} where $u \in V(G) \setminus \{v\}$. *Exposed parts* of the path $P(v)$ are the parts of segments which are either exposed from below or exposed from left. For vertical segments of $P(v)$ we define its *exposed zone* as the infinite horizontal strip just containing the exposed part of this segment (see [Figure 4.2\(a\)](#)). Below we give a $\text{PROPER-}\mathcal{B}_{2k-3}$ representation of G_t . (Notice that $2k - 3 = 4t + 29$.)

Recall that the vertex set of $G_{t,m}$ is $A \cup Q$ where $A = \{a_i \mid i \in [n]\}$ and $Q = \{b_j \mid j \in [\binom{n}{k}]\}$. For $i \in [n]$, a_i is indexed by $[n] \setminus \{i\}$; and for

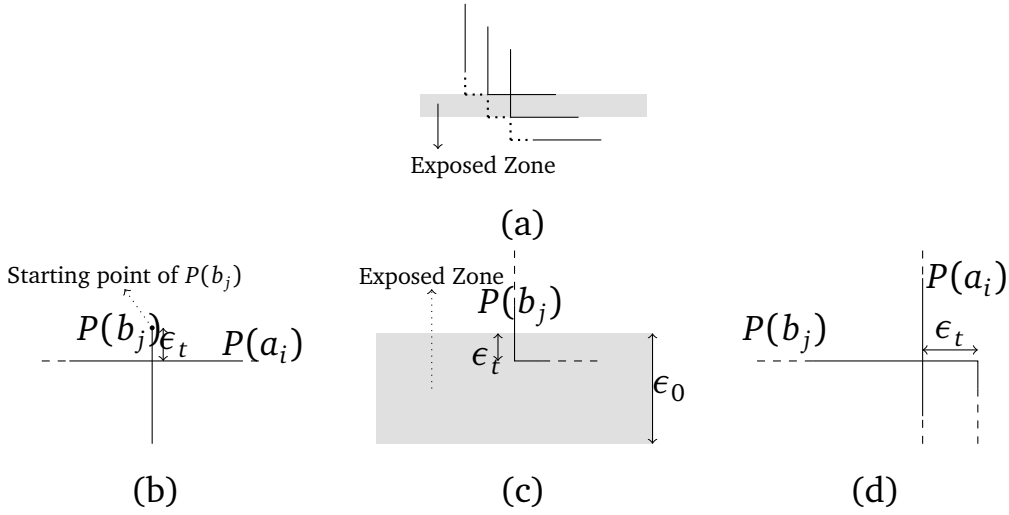

Figure 4.2: (a) Exposed zone is highlighted in grey. (b) shows the starting point of $P(b_j)$. (c) shows the corner point when $P(b_j)$ just enters an exposed zone and (c) shows the corner point when $P(b_j)$ crosses some $P(a_i)$.

$j \in \binom{[n]}{k}$, b_j is indexed by a distinct k -element subset of $[n]$. The edge set $E(G_{t,m}) = \{a_i a_j \mid i \neq j, \forall a_i, a_j \in A\} \cup \{b_i b_j \mid i \neq j, \forall b_i, b_j \in Q\} \cup \{a_i b_j \mid i \text{ belongs to the } k\text{-element subset of } [n] \text{ indexed by } b_j\}$.

First we describe how to represent the vertices of $A = \{a_1, a_2, \dots, a_n\}$. We represent a_1 by a 3-bend stair $P(a_1)$ with direction vector $\langle \rightarrow, \downarrow, \rightarrow \rangle$ with segments of unit length. Let its starting point (first corner point) be the origin, with the usual positive X (\rightarrow) and positive Y (\uparrow) axis orientation. Fix $\epsilon_0 \ll 1$. Now we draw $P(a_i)$, for each $i \in \{2, 3, \dots, n\}$. Each such $P(a_i)$ is a congruent copy of $P(a_1)$ starting from $((i-1)\epsilon_0, -(i-1)\epsilon_0)$ with the same direction vector as $P(a_1)$. The a_i 's, for $i \in [n]$, induce a clique; as for distinct a_i and a_j with $i < j$, the first bend i.e. second corner point of $P(a_i)$ occurs to the left of the second corner point of $P(a_j)$ and the first segment of $P(a_i)$ lies above the first segment of $P(a_j)$, so the second segment of $P(a_i)$ intersects first segment of $P(a_j)$. Let \mathcal{R}_A denote the above bend representation of vertices in A .

Observe that, for each $i \in [n]$, the first ϵ_0 length of the first and third segment of $P(a_i)$ i.e. ϵ_0 length of the first and third segment starting from the first and third corner point respectively, are exposed in \mathcal{R}_A . Similarly the end ϵ_0 length of second and fourth segment of $P(a_i)$ i.e. ϵ_0 length of the second and fourth segment ending at the third and fifth corner point respectively, are also exposed in \mathcal{R}_A (see Figure 4.2(a) and 4.3).

Now for each $b_i \in Q$, for $i \in \binom{n}{k}$, we add $(2k-3)$ -bend stair $P(b_i)$ with direction vector $\langle \downarrow, \rightarrow, \downarrow, \rightarrow, \dots, \downarrow, \rightarrow \rangle$. Assume $\{i_1, i_2, \dots, i_k\}$ is indexed by b_i with $i_1 < i_2 < \dots < i_k$ such that the vertex b_i is adjacent to the vertices $\{a_{i_1}, a_{i_2}, \dots, a_{i_k}\}$. When we say $P(b_i)$ starts *just above* a segment, or *just enters* an exposed zone, or *just crosses* a path, we mean that $P(b_i)$ starts ϵ_t distance above a segment, enters ϵ_t distance into an exposed zone, or crosses and goes on for ϵ_t distance respectively for some $\epsilon_t < \epsilon_0$ (see [Figure 4.2\(b\),\(c\),\(d\)](#)). Also ϵ_t is assumed to take distinct values so as to result in a $\text{PROPER-}\mathcal{B}_{2k-3}$ representation. Next we describe how to draw $P(b_i)$.

The first segment of $P(b_i)$ starts just above the exposed part of the first segment of a_{i_1} . For two vertices $b_j, b_l \in B$, where b_j indexes $\{j_1, j_2, \dots, j_k\}$ and b_l indexes $\{l_1, l_2, \dots, l_k\}$, if $j_1 = l_1$, the horizontal positions of their starting points are lexicographically ordered from left to right. The first bend occurs when $P(b_i)$ just enters the exposed zone of the second segment of $P(a_{i_2})$. For two vertices $b_j, b_l \in B$ with $j_2 = l_2$, the first bends i.e. second corner points are lexicographically ordered from top to bottom. The second bend occurs after $P(b_i)$ just crosses $P(a_{i_2})$. Till now $P(b_i)$ has intersected with $P(a_{i_1})$ and $P(a_{i_2})$. For rest of the bends in $P(b_i)$ we give a general scheme. For intersection with P_{a_r} for $r \in \{3, 4, \dots, k-1\}$, the $(2r-3)$ th bend occurs when $P(b_i)$ just enters the exposed zone of the fourth segment of $P(a_{i_r})$ and the $(2r-2)$ th bend occurs after $P(b_i)$ just crosses $P(a_{i_r})$. For intersection with P_{a_k} , the $(2r-3)$ th bend occurs when $P(b_i)$ just enters the exposed zone of the fourth segment of $P(a_{i_k})$ and ends when $P(b_i)$ just crosses $P(a_{i_k})$ (see [Figure 4.3](#)).

Notice that $P(b_i)$, for $i \in \binom{n}{k}$, crosses $P(a_{i_1})$ and the bends in $P(b_i)$ occur when it either enters an exposed zone of $P(a_{i_r})$, for $r = 2$ to k , or just after crossing $P(a_{i_r})$ for $r = 2$ to $k-1$. It ends just after crossing $P(a_{i_k})$. Hence $P(b_i)$ intersects only $P(a_{i_1}), P(a_{i_2}), \dots, P(a_{i_k})$ among the paths in \mathcal{R}_A . Also every $P(b_i)$ has $2k-3$ bends. Now we prove that b_i 's, for $i \in \binom{n}{k}$, induce a clique. Consider two vertices b_i and b_j with $i \neq j$ where b_i indexes $\{i_1, i_2, \dots, i_k\}$ and b_j indexes $\{j_1, j_2, \dots, j_k\}$ such that $i_1 < i_2 < \dots < i_k$ and $j_1 < j_2 < \dots < j_k$. Without loss of generality assume $\{i_1, i_2, \dots, i_k\}$ is lexicographically less than $\{j_1, j_2, \dots, j_k\}$. Clearly $i_1 \leq j_1$. We prove that $P(b_i)$ and $P(b_j)$ intersect. Recall that, due to the lexicographic ordering constructed in the previous paragraph, if $i_1 = j_1$, then the starting point of $P(b_i)$ lies to the left of that of $P(b_j)$; and if $i_2 = j_2$, then the first bend of $P(b_i)$ lies above that of $P(b_j)$.

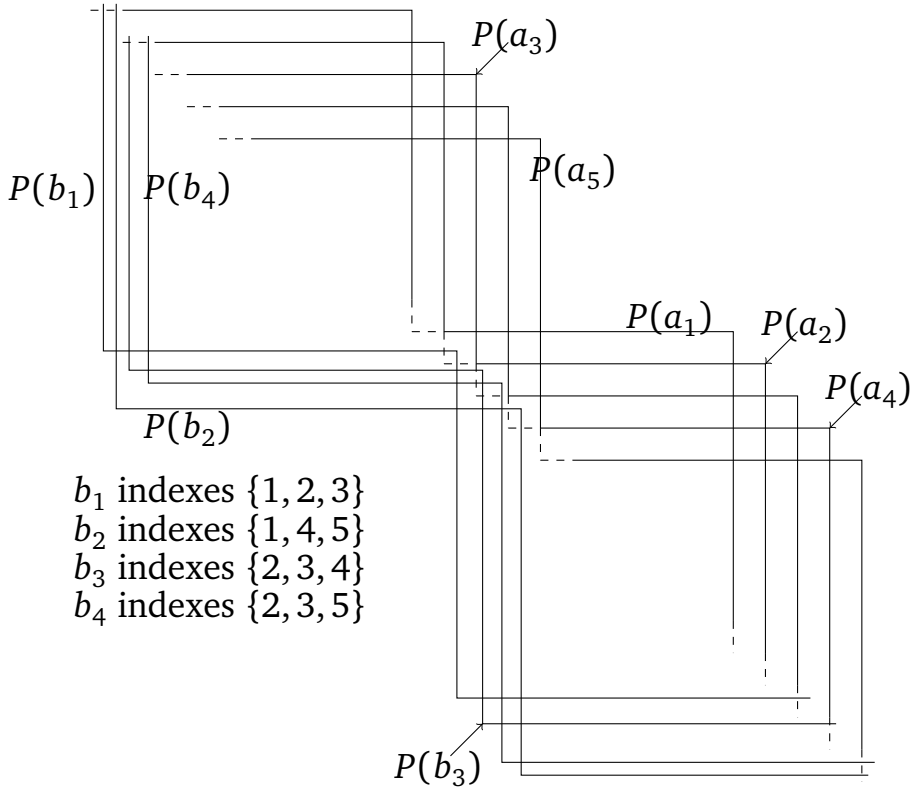

Figure 4.3: Part of \mathcal{B}_{2k-3} representation with $n = 5, k = 3$ (for illustration).

- (i) If $i_2 < j_2$, the first bend of $P(b_i)$ occurs above the first bend of $P(b_j)$ and the starting point of $P(b_i)$ is to the left of the starting point of $P(b_j)$ (even if $i_1 = j_1$, due to the lexicographic ordering); hence the second segment of $P(b_i)$ intersects the first segment of $P(b_j)$. (See paths $P(b_1)$ and $P(b_2)$ in Figure 4.3.)
- (ii) If $i_2 = j_2$, the first bend point of $P(b_i)$ occurs above the first bend of $P(b_j)$ (due to the lexicographic ordering) and the starting point of $P(b_i)$ is to the left of the starting point of $P(b_j)$; hence second segment of $P(b_i)$ intersects the first segment of $P(b_j)$. (See paths $P(b_3)$ and $P(b_4)$ in Figure 4.3.)
- (iii) If $i_2 > j_2$, then $i_1 < j_1$ (else it contradicts the lexicographic ordering between $\{i_1, i_2, \dots, i_k\}$ and $\{j_1, j_2, \dots, j_k\}$). In such a case the first bend point of $P(b_i)$ occurs below that of $P(b_j)$ and the second bend point of $P(b_i)$ occurs to the right of that of $P(b_j)$; hence the second segment of $P(b_i)$ intersects the third segment of $P(b_j)$. (See paths $P(b_2)$ and $P(b_3)$ in Figure 4.3.)

So $P(b_i)$ and $P(b_j)$, for $i, j \in \left[\binom{n}{k} \right]$, intersect and hence b_i 's, for $i \in \left[\binom{n}{k} \right]$,

induce a clique. This completes the $\text{PROPER-}\mathcal{B}_{2k-3}$ representation, that is, $\text{PROPER-}\mathcal{B}_{4t+29}$ representation of G_t . This completes the proof of [Lemma 16](#) and hence of [Theorem 10](#). \square

CLASS $\text{PROPER-}\mathcal{B}_k$

Next, we prove our result on the strict containment of classes based on proper bend number, that is, [Theorem 11](#). For convenience, we recall [Theorem 11](#).

Theorem 11. *For all $t \in \mathbb{N}$, $\text{SPLIT-PROPER-}\mathcal{B}_t \subsetneq \text{SPLIT-PROPER-}\mathcal{B}_{36t+80}$.*

We give a lower bounding argument in [Section 4.6](#), and an upper bound construction in [Section 4.7](#). Our target graph is K_n^3 . Recall that, for $n, k \in \mathbb{N}$ with $n > k$, K_n^k denotes the split graph whose vertex set can be partitioned into a clique C having n vertices and an independent set I of size $\binom{n}{k}$ such that for any subset $C' \subset C$ with $|C'| = k$, there is a unique vertex $u \in I$ with $N(u) = C'$.

In [Section 4.6](#), we show that the proper bend number of K_n^3 is at least $\frac{n-37}{18}$, for all $n \geq 3$. In [Section 4.7](#), we show that for all $n \geq 3$, the graph K_n^3 belongs to $\text{PROPER-}\mathcal{B}_{2n+4}$. Therefore, for all $n \geq 3$, the proper bend number of K_n^3 lies between $\frac{n-37}{18}$ and $2n + 4$.

4.6 The Lower Bound

First, we prove the lower bound of the proper bend number of K_n^3 . Let $n \geq 3$ be a fixed integer. Let G be a graph isomorphic to K_n^3 and A_n, B_n denote the vertices of the clique and independent set of G respectively. Let $\mathcal{R} = \{P(u)\}_{u \in V(G)}$ be a proper B_k -VPG representation of G . For every $b \in B_n$ with $N(b) = \{a_i, a_j, a_l\}$, at least two of their paths, say $P(a_i)$ and $P(a_l)$, intersect $P(b)$ exactly once. Otherwise, we modify $P(b)$ for every $b \in B_n$ as follows. We traverse along the path $P(b)$ from its one end point to another. Consider the sequence of a 's whose corresponding $P(a)$'s are being intersected by $P(b)$. Call the elements appearing in the first and last position of the sequence as *leaf*. Go on removing the leaf from one endpoint of the sequence if the element corresponding to it is also present elsewhere in the sequence. Repeat this process on the remaining sequence from the other endpoint. When

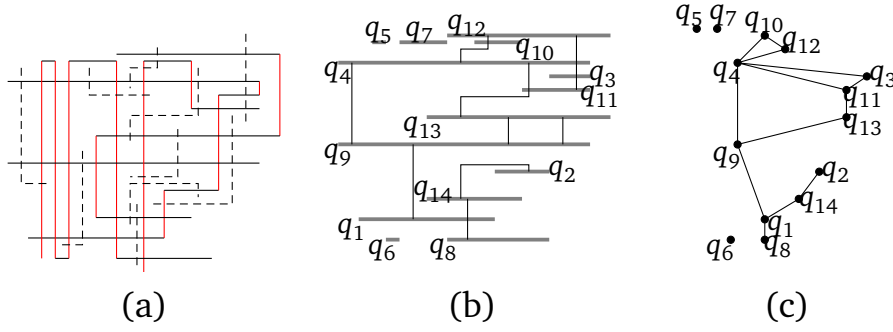

Figure 4.4: (a) Part of B_k -VPG representation of K_5^3 where for $a \in A_n$ and $b \in B_n$, $P(a)$'s are normal lines and $P(b)$'s are dashed lines, (b) Vertices of F_h are represented by the thick gray lines and part of subpaths $P(b)$ as normal lines (c) The planar graph F_h .

this process stops, both the leaves are distinct. Let $P'(b)$ be the subpath of $P(b)$ that intersects the $P(a)$'s corresponding to the a 's in the final sequence. Update $P(b)$ as $P'(b)$.

So, without loss of generality, $P(b)$ intersects either a horizontal or a vertical segment of $P(a_i)$ and $P(a_l)$ exactly once. Moreover $P(b)$ possibly intersects $P(a_j)$ more than once. For rest of this section, we assume that $P(b)$ intersects either a horizontal or a vertical segment of $P(a_i)$ and $P(a_l)$ exactly once.

We form two sets, S_H and S_V , from B_n as follows. A vertex $b \in B_n$, with $N(b) = \{a_i, a_j, a_l\}$, is in the set S_H if $P(b)$ intersects horizontal segments of at least two of $\{P(a_i), P(a_j), P(a_l)\}$. Similarly, $b \in S_V$ if $P(b)$ intersects vertical segments of at least two of $\{P(a_i), P(a_j), P(a_l)\}$.

Observation 14. *The set B_n is union of S_H and S_V .*

Proof. Consider $b \in B_n$ such that $b \notin S_H$. So $P(b)$ intersects horizontal segment of at most one of the paths in $\{P(a_i), P(a_j), P(a_l)\}$. This implies $P(b)$ intersects vertical segments of the other two paths in $\{P(a_i), P(a_j), P(a_l)\}$. Hence $b \in S_V$. \square

We shall count the cardinality of the sets S_H and S_V . Notice that, by [Observation 14](#),

$$\binom{n}{3} = |B_n| \leq |S_H| + |S_V|.$$

Let $\mathcal{R}_A = \{P(a) : a \in A_n\}$. We define two sets R_H and R_V as collection of all horizontal segments and all vertical segments respectively of all the paths in

\mathcal{R}_A .

Now we define graphs F_h and F_v as follows. Define $V(F_h) = R_H$ and $E(F_h) = \{uv : \text{there exists } b \in B_n \text{ such that there is a sub-path of } P(b) \text{ that intersects } u \text{ and } v \text{ and does not intersect any other segment in } R_H\}$. Similarly, $V(F_v) = R_V$ and $E(F_v) = \{uv : \text{there exists } b \in B_n \text{ such that there is a sub-path of } P(b) \text{ that intersects } u \text{ and } v \text{ and does not intersect any other segment in } R_V\}$. It is easy to see that for every $uv \in E(F_h)$, there exists some $b \in B$ such that there exists a subpath $P(uv)$ of $P(b)$ with end-points in u and v and whose interior does not intersect any segment in R_H . Since B_n is an independent set, for any two vertices $b, b' \in B_n$, $P(b)$ and $P(b')$ do not intersect. Also, for any $b \in B_n$, two subpaths of $P(b)$ do not cross, implying that for any two edges $uv, u'v' \in E(F_h)$, the paths $P(uv)$ and $P(u'v')$ do not cross. Thus the horizontal segments in R_H together with the paths in $\{P(uv)\}_{uv \in E(F_h)}$ form a drawing of the graph F_h in the plane in which no two edges cross. Therefore, F_h is a planar graph. In a similar way, it can be seen that F_v is also a planar graph. (See [Figure 4.4](#) for an illustration.) As each of F_h and F_v have at most $n(\frac{k}{2} + 1)$ vertices, and any planar graph G has at most $3|V(G)| - 6$ edges, we have that each of F_h and F_v will have at most $3n(\frac{k}{2} + 1)$ edges. Using these bounds, we prove the following.

Observation 15. $|S_H| \leq 3n(\frac{k}{2} + 1)(n - 2)$ and $|S_V| \leq 3n(\frac{k}{2} + 1)(n - 2)$.

Proof. To each vertex in $b \in S_H$, we shall associate an edge $f(b)$ of F_h and show that at most $(n - 2)$ vertices of S_H get associated with an edge of F_h . Let $b \in S_H$ and $N(b) = \{a_i, a_j, a_l\}$. Then $P(b)$ intersects the horizontal segments of at least two of the paths in $\{P(a_i), P(a_j), P(a_l)\}$. Therefore, if we list the horizontal segments in R_H intersected by $P(b)$ in the order in which they are encountered while traversing $P(b)$ from one of its end-points to the other (there might be repetitions), there will be a pair of consecutive horizontal segments, say $u, v \in R_H$, that belong to two different paths in $\{P(a_i), P(a_j), P(a_l)\}$. It is clear that there is a subpath of $P(b)$ with one end-point in u and the other end-point in v and whose interior points are not contained in any horizontal segment in R_H . Therefore, $uv \in E(F_h)$. We define $f(b) = uv$.

Let $u, v \in R_H$. If there is some vertex $b \in S_H$ such that $f(b) = uv$, then there exist distinct vertices $a_i, a_j \in N(b)$ such that u and v are horizontal

segments of $P(a_i)$ and $P(a_j)$ respectively. As there are at most $(n-2)$ vertices in B_n whose neighbourhood contains a_i and a_j , we have $|\{b \in S_H : f(b) = uv\}| \leq n-2$. Since $|E(F_h)| \leq 3n(\frac{k}{2} + 1)$, we get

$$|S_H| \leq (n-2) |E(F'_h)| \leq 3n(\frac{k}{2} + 1)(n-2).$$

In a similar way, it can also be seen that

$$|S_V| \leq 3n(\frac{k}{2} + 1)(n-2).$$

□

Now, [Observation 14](#) implies the following.

$$\begin{aligned} \binom{n}{3} &\leq |S_H| + |S_V| \\ \Rightarrow \frac{n(n-1)(n-2)}{6} &\leq 6n(\frac{k}{2} + 1)(n-2) \\ \Rightarrow \frac{n-37}{18} &\leq k. \end{aligned}$$

Therefore, $\frac{n-37}{18} \leq \text{bend}_p(K_n^3)$, for all $n \geq 3$.

Next, we give an upper bound construction for K_n^3 .

4.7 The Upper Bound Construction

In this subsection, we prove the following lemma.

Lemma 17. *For all $n \geq 3$, the graph K_n^3 belongs to $\text{PROPER-}\mathcal{B}_{2n+4}$.*

4.7.1 Proof of Lemma 17

Now we shall prove that $\text{bend}_p(K_n^3) \leq 2n+4$, for all $n \geq 3$. For the remainder of this section fix an integer $n \geq 3$. Recall that the clique partition of K_n^3 has n vertices and the independent set partition of K_n^3 has $\binom{n}{3}$ vertices. Let $V_c = \{a_1, a_2, \dots, a_n\}$ denote the vertices in the clique partition of K_n^3 and V_I represent the independent set partition of K_n^3 .

To draw the $\text{PROPER-}\mathcal{B}_{2n+4}$ representation of K_n^3 we use the following standard graph theory result [Har69].

Lemma 18. *The complete graph on $4s + 1$ vertices can be decomposed into $2s$ edge-disjoint Hamiltonian cycles.*

An algorithm for the above decomposition can also be found in [Har69]. Given n we add at most 3 dummy vertices such that the sum is of the form $4s + 1$, for some $s \in \mathbb{N}$. Let H be the complete graph on union of the vertex set $\{a_1, a_2, \dots, a_n\}$ and the dummy vertices. Using Lemma 18 we can infer that there is a set \mathcal{C} consisting of $2s$ edge disjoint hamiltonian cycles that partitions $E(H)$. Let $\{C_1, C_2, \dots, C_{2s}\}$ be the cycles in \mathcal{C} . For each $i \in [2s]$, we form sequence S_i by starting at a_i and including only the indexes of vertices encountered while traversing along the cycle C_i (we do not consider the dummy vertices in the sequence). So S_i begins and ends with i and has other $n - 1$ numbers in between. For any pair (a_i, a_j) we have an edge $a_i a_j \in E(H)$ and therefore $a_i a_j$ is an edge in some hamiltonian cycle of \mathcal{C} . This directly implies the following observation.

Observation 16. *For every distinct $i, j \in [n]$, i and j lie consecutively in some sequence.*

Construction: Fix origin O with the usual X and Y axis. For each odd $i \in [s]$ we fix a square region s_i of dimensions $(n+2) \times (n+2)$ whose bottom left corner and top left corner are fixed at $(2ni, 0)$ and $(2ni, n + 2)$. Similarly for each even $i \in [s]$ we fix a square region s_i of dimensions $(n+2) \times (n+2)$ whose bottom left corner and top left corner are fixed at $(2ni, 0.5)$ and $(2ni, n + 2.5)$.

Now for each odd $i \in [s]$, we draw horizontal line segments at $y = 1, y = 2, \dots, y = n + 1$ such that the horizontal lines partition the square s_i . Similarly for each even $i \in [s]$, we draw horizontal line segments at $y = 1.5, y = 2.5, \dots, y = n + 1.5$ such that the horizontal lines partition the square s_i . Also for each $i \in [s]$, we draw vertical line segments at $x = 2ni + 1, x = 2ni + 2, \dots, x = 2ni + n + 1$ such that the vertical lines partition the square s_i .

For each $i \in [s]$, we use the square region s_i to represent sequences S_i and S_{s+i} . Let the j th vertical line from left in the square s_i be labeled as the j th entry in sequence S_i . Let the j th horizontal line from bottom in the i th square be labeled as the j th entry in sequence S_{s+i} .

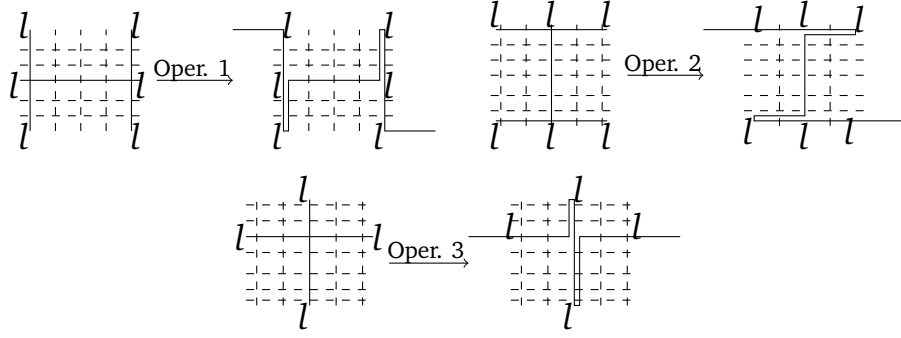

Figure 4.5: Operations for drawing paths.

For each $i \in [2s]$, the sequence S_i begins and ends with i , so the topmost and bottommost line segments of each square have the same label. Similarly, the leftmost and rightmost line segments of each square region have the same label.

Now for each $i \in [n]$ we do a few modifications to make sure that the vertical line segment labeled l does not intersect the horizontal line segment labeled l ; in fact, we merge them into one rectilinear path labeled l . This is depicted in the three operations shown in Figure 4.5.

Observe that every sequence begins with a distinct number, so horizontal segments labeled l undergoes either operation 1 or 2 just once. In rest of the squares, it undergoes operation 3. The set of rectilinear paths so obtained have the following properties: no two segments overlap, every intersection point is contained in exactly two segments and whenever two segments intersect they cross each other.

Recall that V_C is the clique partition of K_n^3 . Now for each $l \in [n]$, we can join the rectilinear curves labeled l to form a single path $P(a_l)$ corresponding to the vertex $a_l \in V_C$. Observe that the set of paths $\mathcal{R}_A = \{P(a)\}_{a \in V_C}$ is a PROPER- \mathcal{B}_k representation of the complete graph induced by V_C in K_n^3 . We shall count the value of k later.

Recall that V_I is the independent set partition of K_n^3 . Now for each $b \in V_I$ we add paths of $P(b)$ in \mathcal{R}_A . Let $N(b) = \{a_p, a_q, a_r\}$, where $1 \leq p < q < r \leq n$. Let $a_p a_q$ be an edge in cycle $C_i \in \mathcal{C}$. So p, q appear consecutively in S_i , and hence $P(a_p)$ and $P(a_q)$ appear consecutively in some square region. In the same square region, $P(a_r)$ intersects both $P(a_p)$ and $P(a_q)$ orthogonally. Now consider a small rectangle just enclosing these intersection points only. Let $P(b)$ be any two consecutive sides of this rectangle. Observe that $P(b)$ has

only one bend and it intersects only $P(a_p), P(a_q)$ and $P(a_r)$. Also observe that all the $P(b_i)$'s do not intersect each other. Therefore, $\mathcal{R} = \{P(a)\}_{a \in V_C} \cup \{P(b)\}_{b \in V_I}$ is a PROPER- \mathcal{B}_k representation of K_n^3 .

Counting: Now we shall count the value of k . Operation 1 needs the most number of bends, hence the path, say $P(a_p)$ undergoing this operation will have maximum bend number amongst all $P(a_i)$'s, for $i \in [n]$. There are s square regions and between each consecutive pair, we need 2 bends. In the one square region where $P(a_p)$ undergoes operation 1 it needs 8 bends and in the rest $s - 1$ regions it needs 6 bends. Hence $P(a_p)$ has total $8 + 6(s - 1) + 2(s - 1) = 8s$ bends which is at most $2n + 4$ bends.

So we have a PROPER- \mathcal{B}_{2n+4} representation of K_n^3 proving that the proper bend number of K_n^3 is at most $2n + 4$. This completes the proof of [Lemma 17](#). See below for an example.

Example: Here we illustrate the process stated in the proof of [Lemma 17](#) by constructing a proper B_{24} -VPG representation of K_{10}^3 . Notice that $P(a_2)$ has 24 bends. By adding three dummy vertices to vertex set $\{a_i : i \in [10]\}$, we construct a complete graph on 13 vertices, and find six edge disjoint Hamiltonian cycles. The six sequences obtained from them, after removing the dummy vertices, are as follows: $S_1 = (1, 2, 3, 4, 5, 6, 7, 8, 9, 10, 1)$, $S_2 = (2, 4, 6, 8, 10, 1, 3, 5, 7, 9, 2)$, $S_3 = (3, 6, 9, 2, 5, 8, 1, 4, 7, 10, 3)$, $S_4 = (4, 8, 3, 7, 2, 6, 10, 1, 5, 9, 4)$, $S_5 = (5, 10, 2, 7, 4, 9, 1, 6, 3, 8, 5)$ and $S_6 = (6, 5, 4, 10, 3, 9, 2, 8, 1, 7, 6)$. So we will have three square regions; the first representing S_1 and S_4 , the second representing S_2 and S_5 , and the third representing S_3 and S_6 . Using the three operations defined in the procedure, we complete the representations in each square region. In the gaps between two consecutive square regions, each path has to change its Y -coordinate, which it can do using two bends. To ensure a proper intersection in these gaps, the X -coordinate of these bends in each path are distinct. See [Figure 4.6](#) for a partial representation. We show $P(b)$'s (in bold) for the b 's that are adjacent to (a_3, a_7, a_{10}) , (a_4, a_6, a_9) , (a_1, a_6, a_8) and (a_5, a_8, a_9) .

This concludes our results on bend graphs.

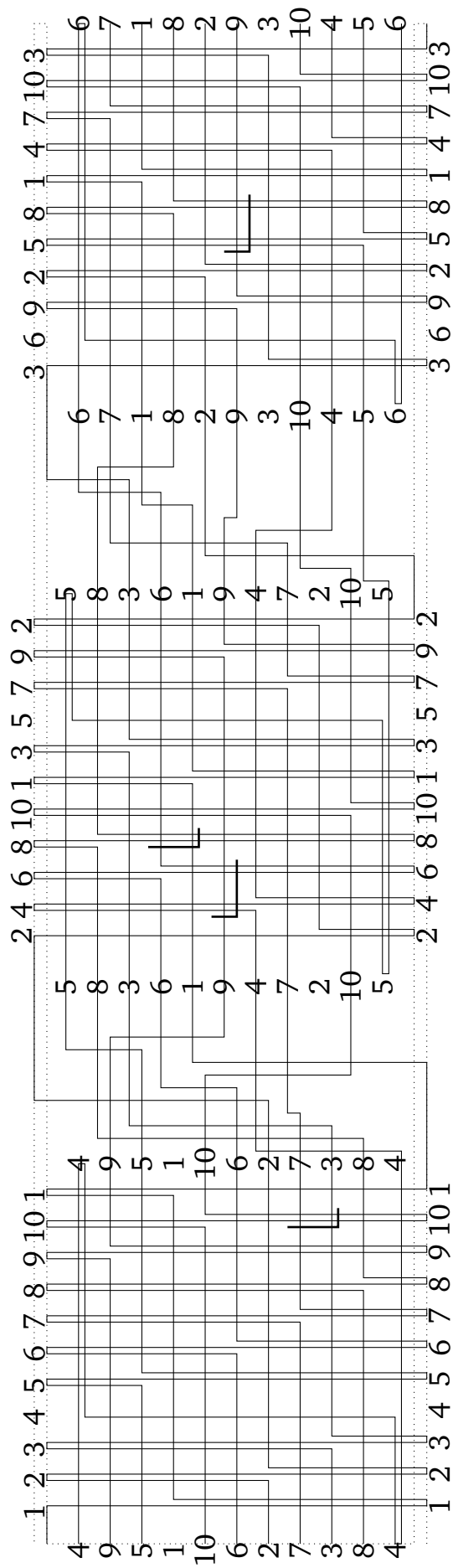

Figure 4.6: Part of PB_{2n+4} -VPG representation of K_{10}^3 .

4.8 Final Remarks

4.8.1 A Digression from our Theme

As one might have noticed, all the main arguments were mostly combinatorial. The intuition of the lower bounding argument in [Section 4.3](#) and the upper bound constructions were geometric in nature. Although we did not extend any geometric arguments to topological ones, we did prove the following more general result on string graphs. Recall the graph class $\mathcal{H}_{n,k}$ from [subsection 4.3.2](#).

Theorem 19. *Every string graph in $\mathcal{H}_{n,k}$, where $k \geq 16$ and $n \geq 2k^2k! + 3$, has bend number at least $\frac{k}{2} - 1$.*

Now, [Theorem 9](#) and [Theorem 10](#) can be derived as corollaries of [Theorem 19](#).

4.8.2 Acknowledgements

We thank Sagnik Sen for helpful comments in preparing the manuscript. We thank Subhodeep Ranjan Dev for carefully reading the final draft of the journal version of this chapter.

We would like to thank the referees of the paper versions of this chapter for meticulously reading the manuscripts, and for useful comments. In particular, we thank one referee of *Theory of Computing Systems*, for his/her insights which made the proofs more rigorous, and increased the readability and flow of the manuscript. One such insight came in form of [Theorem 19](#).

This work was partially supported by the IFCAM project “Applications of graph homomorphisms” (MA/IFCAM/18/39).

5 Interplay

Contents

5.1	Introduction	166
5.2	Coloring 1-string graphs	166
5.2.1	Notations	168
5.3	A proof of Theorem 12	168
5.3.1	The elegant setup of Kostochka and Nešetřil	168
5.3.2	An almost similar second step	169

5.1 Introduction

In the last three chapters of this thesis, we studied two types of geometric graphs that naturally arise from the arrangement of curves in the plane: (i) arrangement graphs (in [Chapter 2](#)) and (ii) intersection (string) graphs (in [Chapter 3](#) and [4](#)). This chapter is more on a concluding note, where we shall discuss the connections between the representations/realizations of these two graph classes. In [Chapter 2](#), we studied line arrangement graphs and pseudoline arrangement graphs. The intersection graphs obtained from these arrangements are not interesting: the intersection graphs are complete graphs. To make things interesting, one can consider the more generalized arrangements of finite curves, where the restriction of pairwise intersection is not there. The intersection graphs obtained from these arrangements are general. In fact, by definition, one can obtain every string graph via these arrangements. This direct natural connection between arrangements of finite curves (or strings) and string graphs is the object of study in this chapter.

5.2 Coloring 1-string graphs

Our exploration concerns the problem of Kostochka and Nešetřil [[KN98](#)] that was the focus of [Chapter 3](#). For convenience, we recall the problem.

The objective of Kostochka and Nešetřil [KN98] was to study a coloring problem on 1-string graphs with girth at least five. We restate their result. Recall that given a class of intersection graphs \mathcal{G} and for a positive integer k , with $k \geq 4$,

$$\chi_g(\mathcal{G}, k) := \max_{G \in \mathcal{G}} \{\chi(G) \mid \text{girth}(G) \geq k\}.$$

The aim is to find or bound $\chi_g(\mathcal{G}, k)$.

Theorem 12. [Kostochka and Nešetřil [KN98]]

$$\chi_g(\text{1-STRING}, k) = \begin{cases} 6, & k \geq 5; \\ 4, & k \geq 6; \\ 3, & k \geq 8. \end{cases}$$

In particular, they proved that 1-string graphs with girth at least five are 6-colorable. In Chapter 3, following a template to attack this problem, we showed that outerstring graphs with girth five are 3-colorable, using a 2-degeneracy argument. We hope to use it to prove that 1-string graphs with girth five are 4-colorable, using a 3-degeneracy argument.

The highlight of the paper [KN98] of Kostochka and Nešetřil is the elegance of their proof of Theorem 12. Their proof can be divided into two parts. In the first part, they find the number of faces in the arrangement realization in terms of the number of vertices and edges of the intersection graph. This connection is where the core of the proof lies. In the second part, they complete the proof by using some properties of color-critical graphs and the Euler's formula. Here we present their proof by making a very slight change in the second step: the Euler's formula is replaced by an averaging argument, which we would be the first to admit is similar to the step of Kostochka and Nešetřil.

We also have another purpose. Recall that Theorem 1 characterizes degree sequences that is realized by a pseudoline arrangement graph. The following two simple observations in the proof of Theorem 1: (i) the vertices of a pseudoline arrangement graph have degrees 2, 3, or 4, and (ii) the end vertex of each pseudoline is either a degree 2 vertex (which is the end vertex of two such pseudolines) or a degree 3 vertex (which is the end vertex of one such pseudoline). These two observations also hold for arrangement graphs

obtained from arrangements of finite curves.

Our purpose here is also to highlight that these simple observations can also be used in the context of string graphs (and to a larger extent in the context of 1-string graphs). First, we begin with some notations.

5.2.1 Notations

Let G_S be a 1-string graph with a 1-string representation \mathbb{G} . We can safely assume the following: (1) strings in \mathbb{G} are simple (not self-intersecting), (2) strings in \mathbb{G} cross at intersection points, and (3) all the intersection points in \mathbb{G} are distinct. We also assume \mathbb{G} to be *trimmed*, that is, both the end-points of each string are also intersection points (the crossing assumption is relaxed at these intersection points).

The arrangement graph induced by \mathbb{G} , denoted as $G_{\mathcal{A}}$, is the graph whose vertices are intersection points of strings in \mathbb{G} , and edges are the parts of strings in \mathbb{G} obtained after removing the intersection points from all the strings.

5.3 A proof of Theorem 12

First, we discuss the setup of Kostochka and Nešetřil [KN98] that studies the properties of the arrangement graph $G_{\mathcal{A}}$ induced by the 1-string representation \mathbb{G} . An easier example was discussed in the introduction chapter in [subsection 1.1.3](#).

5.3.1 The elegant setup of Kostochka and Nešetřil

Let $|V(G_S)| = n$ and $|E(G_S)| = m$, with vertex set $\{v_i \mid 1 \leq i \leq n\}$. In its (trimmed) 1-string representation \mathbb{G} , let string s_i correspond to the vertex v_i , for $1 \leq i \leq n$. Let string s_i intersect with q_i other strings in \mathbb{G} . Then the following equations hold:

$$|V(G_{\mathcal{A}})| = m = \frac{1}{2} \sum_{i=1}^n q_i \quad \text{and} \quad |E(G_{\mathcal{A}})| = \sum_{i=1}^n (q_i - 1) = \sum_{i=1}^n q_i - n. \quad (5.1)$$

Euler's equation implies that the number of faces in the arrangement graph

$$|F(G_{\mathcal{A}})| = |E(G_{\mathcal{A}})| - |V(G_{\mathcal{A}})| + 2 = \frac{1}{2} \sum_{i=1}^n q_i - n + 2 = m - n + 2. \quad (5.2)$$

5.3.2 An almost similar second step

Let f_i denote the number of edges in the i th face. Then we get the following:

$$\sum_{i=1}^{|F(G_{\mathcal{A}})|} f_i = 2 |E(G_{\mathcal{A}})| = 4m - 2n. \quad (5.3)$$

The average length of a face in the arrangement obtained from (5.2) and (5.3), is

$$\bar{f} = \frac{4m - 2n}{m - n + 2} = 4 + \frac{2n - 8}{m - n + 2}. \quad (5.4)$$

Case $k \geq 5$: If $q_i \geq 6$, for all $1 \leq i \leq n$, then $|V(G_{\mathcal{A}})| = m \geq 3n$. This implies that the average face length

$$\bar{f} \leq 4 + \frac{2n - 8}{2n + 2} < 5.$$

Thus, the girth is less than 5; a contradiction. Hence, $G_{\mathcal{S}}$ is 5-degenerate and thereby $\chi(1\text{-STRING}, 5) \leq 6$.

Case $k \geq 6$: If $q_i \geq 4$, for all $1 \leq i \leq n$, then $|V(G_{\mathcal{A}})| = m \geq 2n$. This implies that the average face length

$$\bar{f} \leq 4 + \frac{2n - 8}{n + 2} < 6.$$

Thus, the girth is less than 6; a contradiction. Hence, $G_{\mathcal{S}}$ is 3-degenerate and thereby $\chi(1\text{-STRING}, 6) \leq 4$.

Case $k \geq 8$: If $q_i \geq 3$, for all $1 \leq i \leq n$, then $|V(G_{\mathcal{A}})| = m \geq 1.5n$. This implies that the average face length

$$\bar{f} \leq 4 + \frac{2n - 8}{0.5n + 2} < 8.$$

Thus, the girth is less than 8; a contradiction. Hence, $G_{\mathcal{S}}$ is 2-degenerate and thereby $\chi(1\text{-STRING}, 8) \leq 3$.

This reproves the result of Kostochka and Nešetřil (that is, Theorem 12). □

Remark 14. We first obtained the Equation 5.3 via the simple relations of degrees we obtained while proving Theorem 1 in Chapter 2. The details are highlighted below.

A tool connecting 1-string graphs and the underlying arrangement graph

Consider the degrees of the vertices in the arrangement graph $G_{\mathcal{A}}$. Since at most two strings intersect at a point, the maximum degree of a vertex in the arrangement graph is 4. Since $q_i \geq p$, there are at least $p \geq 2$ intersection points in each string. Thus, there are no degree one vertices in $G_{\mathcal{A}}$. Let d_i , for $2 \leq i \leq 4$, denote the number of vertices with degree i .

Then we have the following relations, which we had rediscovered¹ while studying degree sequences of pseudoline arrangement graphs in Theorem 1 in Chapter 2.

$$d_2 + d_3 + d_4 = |V(G_{\mathcal{A}})| = m, \tag{5.5}$$

$$2d_2 + d_3 = 2n \tag{5.6}$$

Equation (5.5) captures the total number of vertices in $G_{\mathcal{A}}$, which is the same as the number of edges in $G_{\mathcal{S}}$. Equation (5.6) double counts the number of end-points in the n strings: two strings end at the vertex with degree two, and one string ends at the vertex with degree three.

The above equations can be used for example to obtain Equation 5.3 by double counting the sum of degrees. However, the argument presented in the previous subsection is much sleeker.

¹These equations can also be concluded from observations of Bose, Everett, and Wismath [BEW03] and Durocher et al. [DMN⁺13].

Thesis Related Publications

Journal

- (J) D. CHAKRABORTY, S. DAS, J. MUKHERJEE, AND U. K. SAHOO, Bounds on the bend number of split and cocomparability graphs, *Theory of Computing Systems* 63 (2019) 1336–1357. <https://doi.org/10.1007/s00224-019-09912-4>.
- (S) S. DAS, S. B. RAO, AND U. K. SAHOO, Pseudoline arrangement graphs: degree sequences and eccentricities, Submitted to *Discrete Mathematics & Theoretical Computer Science* on 04.03.2021 with manuscript number 7239. <https://arxiv.org/pdf/2103.02283.pdf>.

Conferences and Workshop

- (C) S. DAS, S. B. RAO, AND U. K. SAHOO, On degree sequences and eccentricities in pseudoline arrangement graphs, in: A. Mudgal, C.R. Subramanian (Eds.), *Algorithms and Discrete Applied Mathematics (CALDAM 2021)*, Lecture Notes in Computer Science, vol 12601. Springer, Cham, 2021: pp. 259–271. https://doi.org/10.1007/978-3-030-67899-9_20.
- (C) S. DAS, J. MUKHERJEE, AND U. K. SAHOO, Outer 1-string graphs of girth at least five are 3-colorable, In: J. Nešetřil, G. Perarnau, J. Rué, O. Serra (Eds.), *Extended Abstracts EuroComb 2021*. Trends in Mathematics, vol 14. Birkhäuser, Cham, 2021: pp. 593-598. https://doi.org/10.1007/978-3-030-83823-2_95.
- (W) S. DAS, J. MUKHERJEE, AND U. K. SAHOO, Outerstring graphs of girth at least five are 3-colorable, Extended Abstract in Proceedings of the 37th *European Workshop on Computational Geometry (EuroCG*

2021). eurocg21.spbu.ru/wp-content/uploads/2021/04/EuroCG_2021_paper_70.pdf.

Bibliography

- [Aer15] N. AERTS, *Geometric representations of planar graphs*, Ph.D. Thesis, TU Berlin, 2015. https://depositonce.tu-berlin.de/bitstream/11303/4677/1/aerts_nieke.pdf. (Cited on page 1.)
- [AS00] P. K. AGARWAL AND M. SHARIR, Arrangements and their applications, in: J.-R. Sack, J. Urrutia (Eds.), *Handbook of computational geometry*, North-Holland, Amsterdam, 2000: pp. 49–119. <https://doi.org/10.1016/B978-044482537-7/50003-6>. (Cited on page 11.)
- [Age99] A. A. AGEEV, Every circle graph of girth at least 5 is 3-colourable, *Discrete Mathematics* 195 (1999) 229–233. [https://doi.org/10.1016/S0012-365X\(98\)00192-7](https://doi.org/10.1016/S0012-365X(98)00192-7). (Cited on pages 30, 32, 75, 77, 83, and 109.)
- [ABD⁺15] L. ALCÓN, F. BONOMO, G. DURÁN, M. GUTIERREZ, M. PÍA MAZZOLENI, B. RIES, AND M. VALENCIA-PABON, On the bend number of circular-arc graphs as edge intersection graphs of paths on a grid, *Electronic Notes in Discrete Mathematics* 50 (2015) 249–254. <https://doi.org/10.1016/j.endm.2015.07.042>. (Cited on page 36.)
- [ABM17] L. ALCÓN, F. BONOMO, AND M. P. MAZZOLENI, Vertex intersection graphs of paths on a grid: characterization within block graphs, *Graphs and Combinatorics* 33 (2017) 653–664. <https://doi.org/10.1007/s00373-017-1791-6>. (Cited on page 38.)
- [AS02] B. ARONOV AND M. SHARIR, Cutting circles into pseudo-segments and improved bounds for incidences and complexity of many faces, *Discrete Computational Geometry* 28 (2002) 475–490. <https://doi.org/10.1007/s00454-001-0084-1>. (Cited on page 12.)
- [ABR20] A. ARROYO, J. BENSMAIL, AND R. B. RICHTER, Extending drawings of graphs to arrangements of pseudolines, in: S. Cabello, D.Z. Chen (Eds.), *36th International Symposium on Computational Geometry (SoCG 2020)*,

Schloss Dagstuhl–Leibniz-Zentrum für Informatik, Dagstuhl, Germany, 2020: pp. 9:1-9:14. <https://doi.org/10.4230/LIPIcs.SoCG.2020.9>. (Cited on page 13.)

[ACG⁺12] A. ASINOWSKI, E. COHEN, M. C. GOLUMBIC, V. LIMOUZY, M. LIPSHTEYN, AND M. STERN, Vertex intersection graphs of paths on a grid, *Journal of Graph Algorithms and Applications* 16 (2012) 129–150. <https://doi.org/10.7155/jgaa.00253>. (Cited on pages 34, 35, 37, 38, 39, 140, 142, and 143.)

[AR12] A. ASINOWSKI AND B. RIES, Some properties of edge intersection graphs of single-bend paths on a grid, *Discrete Mathematics* 312 (2012) 427–440. <https://doi.org/10.1016/j.disc.2011.10.005>. (Cited on page 36.)

[AS09] A. ASINOWSKI AND A. SUK, Edge intersection graphs of systems of paths on a grid with a bounded number of bends, *Discrete Applied Mathematics* 157 (2009) 3174–3180. <https://doi.org/10.1016/j.dam.2009.06.015>. (Cited on page 36.)

[AG60] E. ASPLUND AND B. GRÜNBAUM, On a coloring problem, *Mathematica Scandinavica* 8 (1960) 181–188. <https://doi.org/10.7146/math.scand.a-10607>. (Cited on pages 30 and 73.)

[BS79] L. W. BEINEKE AND E. F. SCHMEICHEL, Degrees and cycles in graphs, in: *Proceedings of the 2nd International Conference on Combinatorial Mathematics*, *Annals of the New York Academy of Sciences* 319(1) (1979) 64–70. (Cited on page 69.)

[BKH08] M. D. BARRUS, M. KUMBHAT, AND S. G. HARTKE, Graph classes characterized both by forbidden subgraphs and degree sequences, *Journal of Graph Theory* 57 (2008) 131–148. <https://doi.org/10.1002/jgt.20270>. (Cited on page 69.)

[Ben59] S. BENZER, On the topology of the genetic fine structure, *Proceedings of National Academy of Sciences* 45 (1959) 1607–1620. <https://doi.org/10.1073/pnas.45.11.1607>. (Cited on pages 27 and 28.)

- [BBD18] T. BIEDL, A. BINIAZ, AND M. DERKA, On the size of outer-string representations, in: D. Eppstein (Ed.), *16th Scandinavian Symposium and Workshops on Algorithm Theory (SWAT 2018)*, Schloss Dagstuhl–Leibniz-Zentrum fuer Informatik, Dagstuhl, Germany, 2018: p. 10:1–10:14. <https://doi.org/10.4230/LIPIcs.SWAT.2018.10>. (Cited on pages 110 and 115.)
- [BD16] T. BIEDL AND M. DERKA, 1-string B_2 -VPG representation of planar graphs, *Journal of Computational Geometry* 7 (2016) 191–215. <https://doi.org/10.20382/jocg.v7i2a8>. (Cited on page 37.)
- [BD17] T. BIEDL AND M. DERKA, Splitting B_2 -VPG graphs into outer-string and co-comparability graphs, in: F. Ellen, A. Kolokolova, J.-R. Sack (Eds.), *Algorithms and Data Structures (WADS 2017)*, Springer International Publishing, Cham, 2017: pp. 157–168. https://doi.org/10.1007/978-3-319-62127-2_14. (Cited on page 38.)
- [BDD⁺18] T. BIEDL, M. DERKA, V. DUJMOVIĆ, AND P. MORIN, EPG-representations with small grid-size, in: F. Frati, K.-L. Ma (Eds.), *Graph Drawing and Network Visualization (GD 2018)*, Springer International Publishing, Cham, 2018: pp. 184–196. https://doi.org/10.1007/978-3-319-73915-1_16. (Cited on page 36.)
- [Biy05] T. BIYIKOĞLU, Degree sequences of Halin graphs, and forcibly cograph-graphic sequences, *Ars Combinatorica* 75 (2005) 205–210. (Cited on page 69.)
- [BLS⁺99] A. BJÖRNER, M. LAS VERGNAS, B. STURMFELS, N. WHITE, AND G. M. ZIEGLER, *Oriented matroids*, second ed., volume 46 of *Encyclopedia of Mathematics*, Cambridge University Press, New York, 1999. <https://doi.org/10.1017/CB09780511586507>. (Cited on page 15.)
- [BDK⁺08] P. BOSE, V. DUJMOVIĆ, D. KRIZANC, S. LANGERMAN, P. MORIN, D. R. WOOD, AND S. WUHRER, A characterization of the degree sequences of 2-trees, *Journal of Graph Theory* 58 (2008) 191–209. <https://doi.org/10.1002/jgt.20302>. (Cited on pages 49 and 69.)
- [BEW03] P. BOSE, H. EVERETT, AND S. WISMATH, Properties of arrangement graphs, *International Journal of Computational Geometry and Applications*

- 13 (2003) 447–462. <https://doi.org/10.1142/S0218195903001281>. (Cited on pages 18, 19, 21, 46, 47, 49, 55, and 170.)
- [BS90] M. L. BRADY AND M. SARRAFZADEH, Stretching a knock-knee layout for multilayer wiring, *IEEE Transactions on Computers* 39 (1990) 148–151. <https://doi.org/10.1109/12.46293>. (Cited on page 34.)
- [Bur95] J. P. BURLING, *On coloring problems of families of prototypes*, Ph.D. Thesis, University of Colorado, Boulder, 1995. (Cited on page 72.)
- [BE73] S. A. BURR AND P. ERDŐS, On the magnitude of generalized ramsey numbers for graphs, in: *Infinite and Finite Sets I*, 1973: pp. 215–240. (Cited on page 136.)
- [CJ17] S. CABELLO AND M. JEJČIČ, Refining the hierarchies of classes of geometric intersection graphs, *The Electronic Journal of Combinatorics* 24(1) (2017) P1.33. <https://doi.org/10.37236/6040>. (Cited on pages 39 and 143.)
- [CFM⁺18] J. CARDINAL, S. FELSNER, T. MILTZOW, C. TOMPKINS, AND B. VOGTENHUBER, Intersection graphs of rays and grounded segments, *Journal of Graph Algorithms and Applications* 22 (2018) 273–295. <https://doi.org/10.7155/jgaa.00470>. (Cited on pages 29 and 30.)
- [CG20] E. ÇELA AND E. GAAR, Relationship of k -bend and monotonic ℓ -bend edge intersection graphs of paths on a grid, *ArXiv:2002.05998* [Cs, Math]. (2020). <http://arxiv.org/abs/2002.05998>. (Cited on pages 36, 37, and 141.)
- [Cha20] D. CHAKRABORTY, *Recognition and domination on intersection and overlap graphs of rectangles*, Ph.D. Thesis, ISI Kolkata, 2020. (Cited on page 38.)
- [CDM19] D. CHAKRABORTY, S. DAS, AND J. MUKHERJEE, Approximating minimum dominating set on string graphs, in: I. Sau, D.M. Thilikos (Eds.), *Graph-Theoretic Concepts in Computer Science* (WG 2019), Springer International Publishing, Cham, 2019: pp. 232–243. https://doi.org/10.1007/978-3-030-30786-8_18. (Cited on page 38.)

- [CDM⁺19] D. CHAKRABORTY, S. DAS, J. MUKHERJEE, AND U. K. SAHOO, Bounds on the bend number of split and cocomparability graphs, *Theory of Computing Systems* 63 (2019) 1336–1357. <https://doi.org/10.1007/s00224-019-09912-4>. (Cited on page 44.)
- [CG09] J. CHALOPIN AND D. GONÇALVES, Every planar graph is the intersection graph of segments in the plane: extended abstract, in: *Proceedings of the 41st Annual ACM Symposium on Theory of Computing (STOC 2009)*, Association for Computing Machinery, New York, NY, USA, 2009: pp. 631–638. <https://doi.org/10.1145/1536414.1536500>. (Cited on pages 27 and 76.)
- [CGO10] J. CHALOPIN, D. GONÇALVES, AND P. OCHEM, Planar graphs have 1-string representations, *Discrete Computational Geometry* 43 (2010) 626–647. <https://doi.org/10.1007/s00454-009-9196-9>. (Cited on pages 26 and 27.)
- [CFL⁺17] S. CHAPLICK, K. FLESZAR, F. LIPP, A. RAVSKY, O. VERBITSKY, AND A. WOLFF, The complexity of drawing graphs on few lines and few planes, in: F. Ellen, A. Kolokolova, J.R. Sack (Eds.), *Algorithms and Data Structures (WADS 2017)*, Lecture Notes in Computer Science 10389, Springer, 2017: pp. 265–276. https://doi.org/10.1007/978-3-319-62127-2_23. (Cited on page 47.)
- [CJK⁺12] S. CHAPLICK, V. JELÍNEK, J. KRATOCHVÍL, AND T. VYSKOČIL, Bend-bounded path intersection graphs: sausages, noodles, and waffles on a grill, in: M.C. Golumbic, M. Stern, A. Levy, G. Morgenstern (Eds.), *Graph-Theoretic Concepts in Computer Science (WG 2012)*, Springer, Berlin, Heidelberg, 2012: pp. 274–285. https://doi.org/10.1007/978-3-642-34611-8_28. (Cited on pages 37, 38, 39, 40, 143, and 144.)
- [CU13] S. CHAPLICK AND T. UECKERDT, Planar graphs as VPG-graphs, *Journal of Graph Algorithms and Applications* 17 (2013) 475–494. <https://doi.org/10.7155/jgaa.00300>. (Cited on page 37.)
- [CL85] Y. T. CHING AND D. T. LEE, Finding the diameter of a set of lines, *Pattern Recognition* 18(3/4) (1985) 249–255. [https://doi.org/10.1016/0031-3203\(85\)90050-0](https://doi.org/10.1016/0031-3203(85)90050-0). (Cited on pages 21, 50, and 51.)

- [CH73] V. CHVÁTAL AND P. L. HAMMER, Set-packing and threshold graphs, *Research Report*, Computer Science Department, University of Waterloo, Canada, 1973, pp. 73–21. (Cited on page 70.)
- [CGR14] E. COHEN, M. C. GOLUMBIC, AND B. RIES, Characterizations of cographs as intersection graphs of paths on a grid, *Discrete Applied Mathematics* 178 (2014) 46–57. <https://doi.org/10.1016/j.dam.2014.06.020>. (Cited on pages 36 and 38.)
- [CGT⁺16] E. COHEN, M. C. GOLUMBIC, W. T. TROTTER, AND R. WANG, Posets and VPG graphs, *Order* 33 (2016) 39–49. <https://doi.org/10.1007/s11083-015-9349-9>. (Cited on page 38.)
- [CHK⁺10] M. D. COURY, P. HELL, J. KRATOCHVÍL, AND T. VYSKOČIL, Faithful representations of graphs by islands in the extended grid, in: A. López-Ortiz (Ed.), *Latin American Theoretical Informatics Symposium (LATIN 2010): Theoretical Informatics*, Springer, Berlin, Heidelberg, 2010: pp. 131–142. https://doi.org/10.1007/978-3-642-12200-2_13. (Cited on page 141.)
- [Dan10] C. DANGELMAYR, *Intersection graphs of pseudosegments*, Ph.D. thesis, FU Berlin, 2010. <https://refubium.fu-berlin.de/handle/fub188/8303>. (Cited on pages 1 and 30.)
- [DFT10] C. DANGELMAYR, S. FELSNER, AND W. T. TROTTER, Intersection graphs of pseudosegments: chordal graphs, *Journal of Graph Algorithms and Applications* 14 (2010) 199–220. <https://doi.org/10.7155/jgaa.00204>. (Cited on page 30.)
- [DMS21a] S. DAS, J. MUKHERJEE, AND U. K. SAHOO, Outer 1-string graphs of girth at least five are 3-colorable, In: J. Nešetřil, G. Perarnau, J. Rué, O. Serra (Eds.), *Extended Abstracts EuroComb 2021*. Trends in Mathematics, vol 14. Birkhäuser, Cham, 2021: pp. 593-598. https://doi.org/10.1007/978-3-030-83823-2_95. (Cited on page 44.)
- [DMS21b] S. DAS, J. MUKHERJEE, AND U. K. SAHOO, Outerstring graphs of girth at least five are 3-colorable, Extended Abstract in the Proceedings of the 37th *European Workshop on Computational Geometry*

- (EuroCG 2021). eurocg21.spbu.ru/wp-content/uploads/2021/04/EuroCG_2021_paper_70.pdf. (Cited on page 44.)
- [DRS21] S. DAS, S. B. RAO, AND U. K. SAHOO, On degree sequences and eccentricities in pseudoline arrangement graphs, in: A. Mudgal, C.R. Subramanian (Eds.), *Algorithms and Discrete Applied Mathematics* (CALDAM 2021), Springer International Publishing, Cham, 2021: pp. 259–271. https://doi.org/10.1007/978-3-030-67899-9_20. (Cited on page 44.)
- [DNR⁺18] Z. DENIZ, S. NIVELLE, B. RIES, AND D. SCHINDL, On split B_1 -EPG graphs, in: M.A. Bender, M. Farach-Colton, M.A. Mosteiro (Eds.), *Latin American Theoretical Informatics Symposium* (LATIN 2018): Theoretical Informatics, Springer International Publishing, Cham, 2018: pp. 361–375. https://doi.org/10.1007/978-3-319-77404-6_27. (Cited on page 37.)
- [Der17] M. DERKA, *Restricted string representations*, Ph.D. thesis, University of Waterloo, 2017. <https://uwspace.uwaterloo.ca/handle/10012/12253>. (Cited on page 1.)
- [Dir51] G. A. DIRAC, Collinearity properties of sets of points, *The Quarterly Journal of Mathematics* 2 (1951) 221–227. <https://doi.org/10.1093/qmath/2.1.221>. (Cited on page 51.)
- [DMP18] F. DROSS, M. MONTASSIER, AND A. PINLOU, Partitioning sparse graphs into an independent set and a forest of bounded degree, *The Electronic Journal of Combinatorics* 25(1) (2018) P1.45. <https://doi.org/10.37236/6815>. (Cited on page 137.)
- [DM20] A. DUMITRESCU AND R. MANDAL, New lower bounds for the number of pseudoline arrangements, *Journal of Computational Geometry* 11(1) (2020) 60–92. <https://doi.org/10.20382/jocg.v11i1a3>. (Cited on page 14.)
- [DMN⁺13] S. DUROCHER, D. MONDAL, R. I. NISHAT, AND S. WHITESIDES, A note on minimum-segment drawings of planar graphs, *Journal of Graph Algorithms and Applications* 17(3) (2013) 301–328. <https://dx.doi.org/10.7155/jgaa.00295>. (Cited on pages 47, 55, and 170.)

- [Ede87] H. EDELSBRUNNER, *Algorithms in combinatorial geometry*, first ed., Springer, Berlin, 1987. <https://doi.org/10.1007/978-3-642-61568-9>. (Cited on page 14.)
- [EET76] G. EHRLICH, S. EVEN, AND R. E. TARJAN, Intersection graphs of curves in the plane, *Journal of Combinatorial Theory, Series B* 21 (1976) 8–20. [https://doi.org/10.1016/0095-8956\(76\)90022-8](https://doi.org/10.1016/0095-8956(76)90022-8). (Cited on page 16.)
- [Epp14] D. EPPSTEIN, Drawing arrangement graphs in small grids, or how to play planarity, *Journal of Graph Algorithms and Applications* 18(2) (2014) 211–231. <https://dx.doi.org/10.7155/jgaa.00319>. (Cited on pages 18, 19, 20, 46, and 47.)
- [EGM13] D. EPSTEIN, M. C. GOLUMBIC, AND G. MORGENSTERN, Approximation algorithms for B_1 -EPG Graphs, in: F. Dehne, R. Solis-Oba, J.-R. Sack (Eds.), *Algorithms and Data Structures (WADS 2013)*, Springer, Berlin, Heidelberg, 2013: pp. 328–340. https://doi.org/10.1007/978-3-642-40104-6_29. (Cited on page 36.)
- [Erd46] P. ERDŐS, On sets of distances of n points, *The American Mathematical Monthly* 53 (1946) 248–250. <https://doi.org/10.2307/2305092>. (Cited on page 11.)
- [EP95] P. ERDŐS AND G. PURDY, Extremal problems in combinatorial geometry, in: R.L. Graham et al. (Eds.), *Handbook of Combinatorics*, Vol. I, Elsevier, Amsterdam, 1995, pp. 809–874. (Cited on page 14.)
- [EG60] P. ERDŐS AND T. GALLAI, Graphs with prescribed degrees of vertices, *Matematikai Fizikai Lapok* 11 (1960) 264–274. (Cited on page 20.)
- [EO09] L. ESPERET AND P. OCHEM, On circle graphs with girth at least five, *Discrete Mathematics* 309 (2009) 2217–2222. <https://doi.org/10.1016/j.disc.2008.04.054>. (Cited on pages 30, 32, 75, 77, 83, 109, 135, 136, and 137.)
- [EGT96] D. EU, E. GRÉVREMONT, AND G. T. TOUSSAINT, On envelopes of arrangements of lines, *Journal of Algorithms* 21 (1996) 111–148. <https://doi.org/10.1006/jagm.1996.0040>. (Cited on pages 19, 21, and 50.)

- [Fel97] S. FELSNER, On the number of arrangements of pseudolines, *Discrete Computational Geometry* 18 (1997) 257–267. <https://doi.org/10.1007/PL00009318>. (Cited on page 14.)
- [Fel04] S. FELSNER, *Geometric graphs and arrangements*, Advanced Lectures in Mathematics, first ed., Vieweg Verlag, 2004. <https://doi.org/10.1007/978-3-322-80303-0>. (Cited on pages 1, 9, 12, 14, 18, 52, and 54.)
- [FG17] S. FELSNER AND J. E. GOODMAN, Pseudoline arrangements, in: J.E. Goodman et al. (Eds.), *Handbook of Discrete and Computational Geometry*, third ed., CRC Press, Boca Raton, FL, 2017, pp. 125–157. (Cited on pages 10, 14, and 46.)
- [FHN⁺06] S. FELSNER, F. HURTADO, M. NOY, AND I. STREINU, Hamiltonicity and colorings of arrangement graphs, *Discrete Applied Mathematics*, 154(17) (2006) 2470–2483. <https://doi.org/10.1016/j.dam.2006.04.006>. (Cited on page 19.)
- [FK99] S. FELSNER AND K. KRIEGEL, Triangles in Euclidean arrangements, *Discrete Computational Geometry* 22 (1999) 429–438. <https://doi.org/10.1007/PL00009471>. (Cited on page 14.)
- [FV11] S. FELSNER AND P. VALTR, Coding and counting arrangements of pseudolines, *Discrete Computational Geometry* 46(4) (2011) 405–416. <https://doi.org/10.1007/s00454-011-9366-4>. (Cited on page 14.)
- [FL78] J. FOLKMAN AND J. LAWRENCE, Oriented matroids, *Journal of Combinatorial Theory, Series B* 25 (1978) 199–236. [https://doi.org/10.1016/0095-8956\(78\)90039-4](https://doi.org/10.1016/0095-8956(78)90039-4). (Cited on pages 14 and 15.)
- [FP10] J. FOX AND J. PACH, A separator theorem for string graphs and its applications, *Combinatorics, Probability and Computing* 19 (2010) 371–390. <https://doi.org/10.1017/S0963548309990459>. (Cited on page 26.)
- [FP12] J. FOX AND J. PACH, String graphs and incomparability graphs, *Advances in Mathematics* 230 (2012) 1381–1401. <https://doi.org/10.1016/j.aim.2012.03.011>. (Cited on page 26.)

- [FL16] M. C. FRANCIS AND A. LAHIRI, VPG and EPG bend-numbers of Halin graphs, *Discrete Applied Mathematics* 215 (2016) 95–105. <https://doi.org/10.1016/j.dam.2016.07.007>. (Cited on page 36.)
- [FP84] Z. FÜREDI AND I. PALASTI, Arrangements of lines with a large number of triangles, *Proceedings of the American Mathematical Society* 92 (1984) 561–566. <https://doi.org/10.1090/S0002-9939-1984-0760946-2>. (Cited on page 14.)
- [GMR19] E. GALBY, M.P. MAZZOLENI, AND B. RIES, Proper circular arc graphs as intersection graphs of paths on a grid, *Discrete Applied Mathematics* 262 (2019) 195–202. <https://doi.org/10.1016/j.dam.2019.02.010>. (Cited on page 37.)
- [GGH01] A. GALLUCCIO, L. A. GODDYN, AND P. HELL, High-girth graphs avoiding a minor are nearly bipartite, *Journal of Combinatorial Theory, Series B* 83 (2001) 1–14. <https://doi.org/10.1006/jctb.2000.2009>. (Cited on page 136.)
- [GJ79] M. R. GAREY AND D. S. JOHNSON, *Computers and Intractability: A Guide to the Theory of NP-Completeness*, W. H. Freeman, San Francisco, 1979. <https://dl.acm.org/doi/book/10.5555/574848>. (Cited on page 5.)
- [GIS11] J. GARIBALDI, A. IOSEVICH, AND S. SENGER, *The Erdős Distance Problem*, Student Mathematical Library, Vol. 56, American Mathematical Society, Providence, Rhode Island, 2011. <https://bookstore.ams.org/stml-56>. (Cited on page 11.)
- [GGJ⁺18] T. GAVENČIAK, P. GORDINOWICZ, V. JELÍNEK, P. KLAVÍK, AND J. KRATOCHVÍL, Cops and robbers on intersection graphs, *European Journal of Combinatorics* 72 (2018) 45–69. <https://doi.org/10.1016/j.ejc.2018.04.009>. (Cited on page 32.)
- [GR13] M. C. GOLUMBIC AND B. RIES, On the intersection graphs of orthogonal line segments in the plane: characterizations of some subclasses of chordal graphs, *Graphs and Combinatorics* 29 (2013) 499–517. <https://doi.org/10.1007/s00373-012-1133-7>. (Cited on page 38.)

- [GLS09] M. C. GOLUMBIC, M. LIPSHTEYN, AND M. STERN, Edge intersection graphs of single bend paths on a grid, *Networks* 54 (2009) 130–138. <https://doi.org/10.1002/net.20305>. (Cited on pages 34, 35, and 36.)
- [GRU83] M. C. GOLUMBIC, D. ROTEM, AND J. URRUTIA, Comparability graphs and intersection graphs, *Discrete Mathematics* 43 (1983) 37–46. [https://doi.org/10.1016/0012-365X\(83\)90019-5](https://doi.org/10.1016/0012-365X(83)90019-5). (Cited on page 26.)
- [GIP18] D. GONÇALVES, L. ISENMANN, AND C. PENNARUN, Planar graphs as L-intersection or L-contact graphs, in: *Proceedings of the 29th Annual ACM-SIAM Symposium on Discrete Algorithms (SODA 2018)*, Society for Industrial and Applied Mathematics, 2018: pp. 172–184. <https://doi.org/10.1137/1.9781611975031.12>. (Cited on pages 27, 37, and 76.)
- [Goo80] J. E. GOODMAN, Proof of a conjecture of Burr, Grünbaum and Sloane, *Discrete Mathematics* 32 (1980) 27–35. [https://doi.org/10.1016/0012-365X\(80\)90096-5](https://doi.org/10.1016/0012-365X(80)90096-5). (Cited on page 52.)
- [GP84] J. E. GOODMAN AND R. POLLACK, Semispaces of configurations, cell complexes of arrangements, *Journal of Combinatorial Theory, Series A* 37 (1984) 257–293. [https://doi.org/10.1016/0097-3165\(84\)90050-5](https://doi.org/10.1016/0097-3165(84)90050-5). (Cited on pages 46 and 52.)
- [GT13] B. GREEN AND T. TAO, On sets defining few ordinary lines, *Discrete Computational Geometry* 50 (2013) 409–468. <https://doi.org/10.1007/s00454-013-9518-9>. (Cited on page 12.)
- [GHK73] D. L. GREENWELL, R.L. HEMMINGER, AND J. KLEITMAN, Forbidden subgraphs, in: *Proceedings of the 4th South East Conference of Graph Theory and Computing*, Florida Atlantic University, 1973: pp. 389–394. (Cited on page 49.)
- [Grü72] B. GRÜNBAUM, *Arrangements and spreads*, Regional Conference Series in Mathematics, American Mathematical Society, Providence, RI, 1972. <https://doi.org/10.1090/CBMS%2F010>. (Cited on pages 14, 15, and 46.)

- [Gyá87] A. GYÁRFÁS, Problems from the world surrounding perfect graphs, *Appliciones Mathematicae* 19 (1987) 413–441. (Cited on pages 31 and 74.)
- [Hak62] S. L. HAKIMI, On realizability of a set of integers as degrees of the vertices of a linear graph. I, *Journal of the Society for Industrial and Applied Mathematics* 10 (1962) 496–506. (Cited on page 20.)
- [HS78] S. L. HAKIMI AND E. F. SCHMEICHEL, Graphs and their degree sequences: a survey, in: Y. Alavi, D.R. Lick (Eds.) *Theory and Applications of Graphs*, Lecture Notes in Mathematics, vol 642. Springer, Berlin, Heidelberg 1978: pp. 225–235. (Cited on page 69.)
- [HIS78] P. L. HAMMER, T. IBARAKI, AND B. SIMEONE, Degree sequences of threshold graphs, *Congres. Numer.* 21 (1978) 321–355. (Cited on page 70.)
- [HS81] P. L. HAMMER AND B. SIMEONE, The splittance of a graph, *Combinatorica* 1 (1981) 275–284. <https://doi.org/10.1007/BF02579333>. (Cited on pages 49 and 69.)
- [Har69] F. HARARY, *Graph theory*, Addison-Wesley, Boston, 1969. <https://doi.org/10.1201/9780429493768>. (Cited on page 161.)
- [Hav55] V. HAVEL, A remark on the existence of finite graphs, *Časopis pro pěstování matematiky* 80 (1955) 477–480. (Cited on page 20.)
- [HKM⁺09] F. HAVET, R. J. KANG, T. MÜLLER, AND J.-S. SERENI, Circular choosability, *Journal of Graph Theory* 61 (2009) 241–270. <https://doi.org/10.1002/jgt.20375>. (Cited on page 137.)
- [HKU14a] D. HELDT, K. KNAUER, AND T. UECKERDT, Edge-intersection graphs of grid paths: the bend-number, *Discrete Applied Mathematics* 167 (2014) 144–162. <https://doi.org/10.1016/j.dam.2013.10.035>. (Cited on page 36.)
- [HKU14b] D. HELDT, K. KNAUER, AND T. UECKERDT, On the bend-number of planar and outerplanar graphs, *Discrete Applied Mathematics* 179 (2014) 109–119. <https://doi.org/10.1016/j.dam.2014.07.015>. (Cited on page 35.)

- [JU17] S. JANSON AND A. J. UZZELL, On string graph limits and the structure of a typical string graph, *Journal of Graph Theory* 84 (2017) 386–407. <https://doi.org/10.1002/jgt.22031>. (Cited on page 30.)
- [JT19] V. JELÍNEK AND M. TÖPFER, On grounded L-graphs and their relatives, *The Electronic Journal of Combinatorics* 26(3) (2019) P3.17. <https://doi.org/10.37236/8096>. (Cited on pages 30 and 76.)
- [KTE⁺09] K. KIM, Z. TOROCKZAI, P. L. ERDŐS, I. MILKÓS, AND L. A. SZÉKELY, Degree-based graph construction, *Journal of Physics A: Mathematical and Theoretical* 42 (2009) 392001. <https://doi.org/10.1088/1751-8113/42/39/392001>. (Cited on page 49.)
- [KN95] A. V. KOSTOCHKA AND J. NEŠETŘIL, Chromatic number of geometric intersection graphs, in: 1995 *Prague Midsummer Combinatorial Workshop*, 1995: pp. 43–45. (Cited on pages 31 and 74.)
- [KN98] A. V. KOSTOCHKA AND J. NEŠETŘIL, Coloring relatives of intervals on the plane, I: chromatic number versus girth, *European Journal of Combinatorics* 19 (1998) 103–110. <https://doi.org/10.1006/eujc.1997.0151>. (Cited on pages 16, 17, 30, 31, 41, 43, 55, 73, 74, 77, 83, 138, 166, 167, and 168.)
- [KN02] A. V. KOSTOCHKA AND J. NEŠETŘIL, Colouring relatives of intervals on the plane, II: intervals and rays in two directions, *European Journal of Combinatorics* 23 (2002) 37–41. <https://doi.org/10.1006/eujc.2000.0433>. (Cited on page 73.)
- [Knu92] D.E. KNUTH, *Axioms and Hulls*, Lecture Notes in Computer Science, Vol. 606, first ed., Springer, Berlin, 1992. <https://doi.org/10.1007/3-540-55611-7>. (Cited on page 14.)
- [Kra91a] J. KRATOCHVÍL, String graphs. I. The number of critical nonstring graphs is infinite, *Journal of Combinatorial Theory, Series B* 52 (1991) 53–66. [https://doi.org/10.1016/0095-8956\(91\)90090-7](https://doi.org/10.1016/0095-8956(91)90090-7). (Cited on pages 26 and 29.)
- [Kra91b] J. KRATOCHVÍL, String graphs. II. recognizing string graphs is NP-hard, *Journal of Combinatorial Theory, Series B* 52 (1991) 67–78. [https://doi.org/10.1016/0095-8956\(91\)90090-7](https://doi.org/10.1016/0095-8956(91)90090-7). (Cited on pages 26 and 29.)

[//doi.org/10.1016/0095-8956\(91\)90091-W](https://doi.org/10.1016/0095-8956(91)90091-W). (Cited on pages 27 and 28.)

- [Kra11] J. KRATOCHVÍL, Can they cross? and how? (the hitchhiker's guide to the universe of geometric intersection graphs), in: *Proceedings of the 27th Annual Symposium on Computational Geometry (SoCG 2011)*, Association for Computing Machinery, New York, NY, USA, 2011: pp. 75–76. <https://doi.org/10.1145/1998196.1998208>. (Cited on page 26.)
- [KM91] J. KRATOCHVÍL AND J. MATOUŠEK, String graphs requiring exponential representations, *Journal of Combinatorial Theory, Series B* 53 (1991) 1–4. [https://doi.org/10.1016/0095-8956\(91\)90050-T](https://doi.org/10.1016/0095-8956(91)90050-T). (Cited on pages 26 and 27.)
- [KM94] J. KRATOCHVÍL AND J. MATOUŠEK, Intersection graphs of segments, *Journal of Combinatorial Theory, Series B* 62 (1994) 289–315. <https://doi.org/10.1006/jctb.1994.1071>. (Cited on page 25.)
- [Kyn13] J. KYNČL, Improved enumeration of simple topological graphs, *Discrete Computational Geometry* 50 (2013) 727–770. <https://doi.org/10.1007/s00454-013-9535-8>. (Cited on page 30.)
- [Lee17] C. LEE, Ramsey numbers of degenerate graphs, *Annals of Mathematics* 185 (2017) 791–829. <https://doi.org/10.4007/annals.2017.185.3.2>. (Cited on page 136.)
- [Lev26] F. LEVI, Die teilung der projektiven ebene durch gerade oder pseudogerade, *Ber. Math.-Phys. Kl. Sächs. Akad. Wiss. Leipzig*, 78 (1926) 256–267. (Cited on pages 10, 14, 46, 54, and 67.)
- [LMS15] A. LAHIRI, J. MUKHERJEE, AND C. R. SUBRAMANIAN, Maximum independent set on B_1 -VPG graphs, in: Z. Lu, D. Kim, W. Wu, W. Li, D.-Z. Du (Eds.), *Combinatorial Optimization and Applications (COCOA 2015)*, Springer International Publishing, Cham, 2015: pp. 633–646. https://doi.org/10.1007/978-3-319-26626-8_46. (Cited on page 38.)
- [Lov19] L. LOVÁSZ, *Graphs and geometry*, Colloquium Publications, Vol. 65, American Mathematical Society, Providence, Rhode Island, 2019. <https://doi.org/10.1090/coll/065>. (Cited on pages 1 and 3.)

- [Lov83] L. LOVÁSZ, Perfect graphs, In Beineke, L.W.; Wilson, R.J. (eds.), *Selected Topics in Graph Theory*, Vol. 2, Academic Press, 1983: pp. 55–87. (Cited on page 26.)
- [Mae84] H. MAEHARA, Space graphs and sphericity, *Discrete Applied Mathematics* 7 (1984) 55–64. [https://doi.org/10.1016/0166-218X\(84\)90113-6](https://doi.org/10.1016/0166-218X(84)90113-6). (Cited on page 24.)
- [Mar45] E. SZPILRAJN-MARCZEWSKI, Sur deux propriétés des classes d'ensembles, *Fundamenta Mathematicae* 33 (1945) 303–307. (Cited on page 23.)
- [Mat02] J. MATOUŠEK, *Lectures on Discrete Geometry*, Springer-Verlag New York, 2002. <https://doi.org/10.1007/978-1-4613-0039-7>. (Cited on pages 5, 12, 13, 14, 24, and 47.)
- [Mat14] J. MATOUŠEK, String graphs and separators, in: J. Matoušek, J. Nešetřil, M. Pellegrini (Eds.), *Geometry, Structure and Randomness in Combinatorics*, Scuola Normale Superiore, Pisa, 2014: pp. 61–97. https://doi.org/10.1007/978-88-7642-525-7_5. (Cited on page 26.)
- [Mc96] S. MCGUINNESS, On bounding the chromatic number of L-graphs, *Discrete Mathematics* 154 (1996) 179–187. [https://doi.org/10.1016/0012-365X\(95\)00316-0](https://doi.org/10.1016/0012-365X(95)00316-0). (Cited on pages 32 and 76.)
- [Mc00a] S. MCGUINNESS, Colouring arcwise connected sets in the plane I, *Graphs and Combinatorics* 16 (2000) 429–439. <https://doi.org/10.1007/PL00007228>. (Cited on page 73.)
- [Mc00b] S. MCGUINNESS, Colouring arcwise connected sets in the plane II, *Graphs and Combinatorics* 17 (2001) 135–148. <https://doi.org/10.1007/PL00007235>. (Cited on page 30.)
- [Meh18] S. MEHRABI, Approximating domination on intersection graphs of paths on a grid, in: R. Solis-Oba, R. Fleischer (Eds.), *Approximation and Online Algorithms* (WAOA 2018), Springer International Publishing, Cham, 2018: pp. 76–89. https://doi.org/10.1007/978-3-319-89441-6_7. (Cited on page 38.)

- [Mel40] E. MELCHIOR, Über vielseitige der projektiven ebene, *Deutsche Mathematik* 5 (1940) 461–475. (Cited on pages 12 and 14.)
- [Mer03] R. MERRIS, Split graphs, *European Journal of Combinatorics* 24(4) (2003) 413–430. [https://doi.org/10.1016/S0195-6698\(03\)00030-1](https://doi.org/10.1016/S0195-6698(03)00030-1). (Cited on pages 49 and 69.)
- [MM99] T. A. MCKEE AND F. R. MCMORRIS, *Topics in Intersection Graph Theory*, Society for Industrial and Applied Mathematics, Philadelphia, 1999. <https://doi.org/10.1137/1.9780898719802>. (Cited on pages 1 and 23.)
- [Mne88] N. E. MNEV, The universality theorems on the classification problem of configuration varieties and convex polytopes varieties, in: O.Y. Viro, A.M. Vershik (Eds.), *Topology and Geometry — Rohlin Seminar*, Springer, Berlin, Heidelberg, 1988: pp. 527–543. <https://doi.org/10.1007/BFb0082792>. (Cited on page 14.)
- [MT01] B. MOHAR AND C. THOMASSEN, *Graphs on surfaces*, Johns Hopkins University Press, 2001. <https://doi.org/10.5860/choice.39-4635>. (Cited on pages 83 and 84.)
- [Mol91] P. MOLITOR, A survey on wiring, *Journal of Information Processing and Cybernetics*, 27(1) (1991) 3–19. (Cited on page 34.)
- [Myc55] J. MYCIELSKI, Sur le coloriage des graphes, *Colloquium Mathematicae* 3 (1955) 161–162. (Cited on page 72.)
- [Neš13] J. NEŠETŘIL, A combinatorial classic – sparse graphs with high chromatic number, in: L. Lovász, I.Z. Ruzsa, V.T. Sós (Eds.), *Erdős Centennial*, Springer, Berlin, Heidelberg, 2013: pp. 383–407. https://doi.org/10.1007/978-3-642-39286-3_15. (Cited on page 30.)
- [ORW19] Y. OKAMOTO, A. RAVSKY, AND A. WOLFF, Variants of the segment number of a graph, in: Archambault D., Tóth C. (Eds.), *Graph Drawing and Network Visualization (GD 2019)*, Springer, Lecture Notes in Mathematics 11904 (2019) 430–443. https://doi.org/10.1007/978-3-030-35802-0_33. (Cited on page 48.)

- [Pac14] J. PACH, Geometric intersection patterns and the theory of topological graphs, in: Proceedings of the *International Congress of Mathematicians* 2014, Seoul, 2014: pp. 455–475. (Cited on page 24.)
- [PRY20] J. PACH, B. A. REED, AND Y. YUDITSKY, Almost all string graphs are intersection graphs of plane convex sets, *Discrete Computational Geometry* 63 (2020) 888–917. <https://doi.org/10.1007/s00454-020-00213-z>. (Cited on page 25.)
- [PT06] J. PACH AND G. TÓTH, How many ways can one draw a graph?, *Combinatorica* 26 (2006) 559–576. <https://doi.org/10.1007/s00493-006-0032-z>. (Cited on pages 27 and 30.)
- [PT02] J. PACH AND G. TÓTH, Recognizing string graphs is decidable, *Discrete Computational Geometry* 28 (2002) 593–606. <https://doi.org/10.1007/s00454-002-2891-4>. (Cited on page 27.)
- [PKK⁺14] A. PAWLIK, J. KOZIK, T. KRAWCZYK, M. LASOŃ, P. MICEK, W. T. TROTTER, AND B. WALCZAK, Triangle-free intersection graphs of line segments with large chromatic number, *Journal of Combinatorial Theory, Series B* 105 (2014) 6–10. <https://doi.org/10.1016/j.jctb.2013.11.001>. (Cited on pages 30, 31, and 74.)
- [PR17] M. PERGEL AND P. RZAŻEWSKI, On edge intersection graphs of paths with 2 bends, *Discrete Applied Mathematics* 226 (2017) 106–116. <https://doi.org/10.1016/j.dam.2017.04.023>. (Cited on page 36.)
- [Rao81a] A. R. RAO, Degree sequences of cacti, in: Proceedings of *Combinatorics and graph theory* (Calcutta, 1980), Lecture Notes in Mathematics, Vol. 885, Springer, Berlin-New York, 1981: pp. 410–416. (Cited on page 69.)
- [Rao81b] S. B. RAO, A survey of the theory of potentially P-graphic and forcibly P-graphic degree sequences, in: Proceedings of *Combinatorics and graph theory* (Calcutta, 1980), Lecture Notes in Mathematics, Vol. 885, Springer, Berlin-New York, 1981: pp. 417–440. (Cited on page 69.)
- [Rie09] B. Ries, Some properties of edge intersection graphs of single bend paths on a grid, *Electronic Notes in Discrete Mathematics* 34 (2009)

- 29–33. <https://doi.org/10.1016/j.endm.2009.07.005>. (Cited on page 36.)
- [Rin56] G. RINGEL, Teilungen der ebene durch geraden oder topologische geraden, *Mathematische Zeitschrift* 64 (1956) 79–102. <https://doi.org/10.1007/BF01166556>. (Cited on pages 10 and 46.)
- [Rin57] G. RINGEL, Über geraden in allgemeiner lage, *Elemente der Mathematik* 12 (1957) 75–81. (Cited on page 10.)
- [Rob69] F. S. ROBERTS, On the boxicity and cubicity of a graph, in W.T. Tutte (Ed.), *Recent Progress in Combinatorics*, Academic Press, 1969: pp. 301–310. (Cited on page 24.)
- [RW19a] A. ROK AND B. WALCZAK, Outerstring graphs are χ -bounded, *SIAM Journal of Discrete Mathematics* 33 (2019) 2181–2199. <https://doi.org/10.1137/17M1157374>. (Cited on page 73.)
- [RW19b] A. ROK AND B. WALCZAK, Coloring curves that cross a fixed curve, *Discrete Computational Geometry* 61 (2019) 830–851. <https://doi.org/10.1007/s00454-018-0031-z>. (Cited on page 73.)
- [Sau21] L. SAUERMANN, On the speed of algebraically defined graph classes, *Advances in Mathematics* 380 (2021) 107593. <https://doi.org/10.1016/j.aim.2021.107593>. (Cited on page 30.)
- [Sch09] M. SCHAEFER, Complexity of some geometric and topological problems, in: Eppstein D., Gansner E.R. (Eds.), *Graph Drawing and Network Visualization* (GD 2009), Springer, Lecture Notes in Mathematics 5849 (2010) 334–344. https://doi.org/10.1007/978-3-642-11805-0_32. (Cited on pages 5, 14, 25, 47, and 49.)
- [SSŠ03] M. SCHAEFER, E. SEDGWICK, AND D. ŠTEFANKOVIČ, Recognizing string graphs in NP, *Journal of Computer and System Sciences* 67 (2003) 365–380. [https://doi.org/10.1016/S0022-0000\(03\)00045-X](https://doi.org/10.1016/S0022-0000(03)00045-X). (Cited on page 28.)
- [SŠ04] M. SCHAEFER AND D. ŠTEFANKOVIČ, Decidability of string graphs, *Journal of Computer and System Sciences* 68 (2004) 319–334. <https://doi.org/10.1016/j.jcss.2003.07.002>. (Cited on page 27.)

- [Sch84] E. R. SCHEINERMAN, *Intersection Classes and Multiple Intersection Parameters of Graphs*, Ph.D. Thesis, Princeton University, 1984. (Cited on page 76.)
- [SS20] A. SCOTT AND P. SEYMOUR, A survey of χ -boundedness, *Journal of Graph Theory* 95 (2020) 473–504. <https://doi.org/10.1002/jgt.22601>. (Cited on page 73.)
- [SA95] M. SHARIR AND P. K. AGARWAL, *Davenport-Schinzel Sequences and Their Geometric Applications*, Cambridge University Press, Cambridge, 1995. (Cited on page 13.)
- [Sho91] P. W. SHOR, Stretchability of pseudolines is NP-hard, in: P. Gritzmann and B. Sturmfels (Eds.), *Applied Geometry and Discrete Mathematics: The Victor Klee Festschrift*, DIMACS Series in Discrete Mathematics and Theoretical Computer Science 4 (1991) 531–554. <https://doi.org/10.1090/dimacs/004/41>. (Cited on page 14.)
- [Sin66] F. W. SINDEN, Topology of thin film RC circuits, *Bell System Technical Journal* 45 (1966) 1639–1662. <https://doi.org/10.1002/j.1538-7305.1966.tb01713.x>. (Cited on pages 26, 27, and 28.)
- [Ste26] J. STEINER, Einige Gesetze über die theilung der ebene und des raumes, *Journal für die reine und angewandte Mathematik* 1 (1826) 349–364. (Cited on page 13.)
- [Tie05] H. TIETZE, Über das problem der nachbargebiete im raum, *Monatshefte für Mathematik und Physik* 16 (1905) 211–216. <https://doi.org/10.1007/BF01693778>. (Cited on pages 24 and 25.)
- [WZ21] H. WANG AND J. ZHANG, An $O(n \log n)$ -time algorithm for the k -center problem in trees, *SIAM Journal of Computing* 50 (2021) 602–635. <https://doi.org/10.1137/18M1196522>. (Cited on page 13.)
- [Wei21] E. W. WEISSTEIN, *Pappus's Hexagon Theorem*, From MathWorld—A Wolfram Web Resource, <https://mathworld.wolfram.com/PappussHexagonTheorem.html> (accessed on 21.08.21). (Cited on page 46.)

- [Wes01] D. B. WEST, *Introduction to Graph Theory*, second ed., Prentice-Hall, New Jersey, 2001. <https://faculty.math.illinois.edu/~west/igt/>. (Cited on pages 5 and 70.)
- [Whi32] H. WHITNEY, Congruent graphs and the connectivity of graphs, *American Journal of Mathematics* 54 (1932) 150–168. <https://doi.org/10.2307/2371086>. (Cited on page 46.)
- [Zah19] J. ZAHL, Breaking the $3/2$ barrier for unit distances in three dimensions, *International Mathematics Research Notices* 2019(20) (2019) 6235–6284. <https://doi.org/10.1093/imrn/rnx336>. (Cited on page 12.)
- [Zhu01] X. ZHU, Circular chromatic number: a survey, *Discrete Mathematics* 229 (2001) 371–410. [https://doi.org/10.1016/S0012-365X\(00\)00217-X](https://doi.org/10.1016/S0012-365X(00)00217-X). (Cited on page 136.)
- [Zhu05] X. ZHU, Circular choosability of graphs, *Journal of Graph Theory* 48 (2005) 210–218. <https://doi.org/10.1002/jgt.20051>. (Cited on page 137.)
- [Zyk49] A. ZYKOV, On some properties of linear complexes, *Matematicheskii Sbornik (Novaya Seriya)* 24 (1949), 163–188. (Cited on page 72.)